

PRELIMINARY

INTRODUCTION

The EB-RD35 is an evaluation and reference design platform for Routing and Distribution applications using the **GENLINX™ II** GS9024 Equalizer, the GS9035 Reclocker, and the GS9028 Cable Driver.

CIRCUIT DESCRIPTION

A functional block diagram is shown below and illustrates the primary circuit functions. These include equalization, reclocking, and driving 75Ω co-axial cables. A complete schematic is also included.

The EB-RD35 accepts a serial digital data input signal which first goes into the GS9024 equalizer. Equalization of the input signal is completely automatic for signal attenuation due to cable length from 0dB to in excess of 30dB. The signal strength/carrier detect output of the equalizer, which is proportional to the amount of equalization taking place, is available via test point TP3. Also available as an output, is the equalizer "Output Eye Monitor" signal via a SMA connector (J6). The signal strength/carrier detect and Output Eye Monitor are useful diagnostic outputs.

After equalization, the differential data signal is passed to the GS9035 reclocker which generates clock and retimed data signals. In addition, the complementary serial clock output signals are available at BNC connectors J2 and J3. The GS9035 also drives data rate indication

LEDs and a LOCK LED which is provided to visually indicate when the reclocker has locked to the incoming video signal.

The reclocked data signals are then supplied to the GS9028 cable driver which provides two complementary data outputs at BNC connectors J4 and J5. The GS9028 is configured to drive 75Ω co-axial cables with SMPTE defined 800mV levels.

BOARD SET-UP AND TEST

The board is configured in SMPTE, auto-tune mode and supports five data rates: 143Mb/s, 177Mb/s, 270Mb/s, 360Mb/s, and 540Mb/s. LED indicators are used to indicate when the device is LOCKed and the detected data rate as shown below:

	SS2	SS1	SS0
143Mb/s	0	0	0
177Mb/s	0	0	1
270Mb/s	0	1	0
360Mb/s	0	1	1
540Mb/s	1	0	0

The GS9035 can also be configured for manual mode by first putting the AUTO/MANUAL jumper (JMP2) into the 2-3 position. Then jumpers JMP[7:5] are set accordingly.

Note that whenever the AUTO/MANUAL input of the GS9035 is HIGH (auto mode), jumpers JMP[7:5] should be left floating to avoid bus contention.

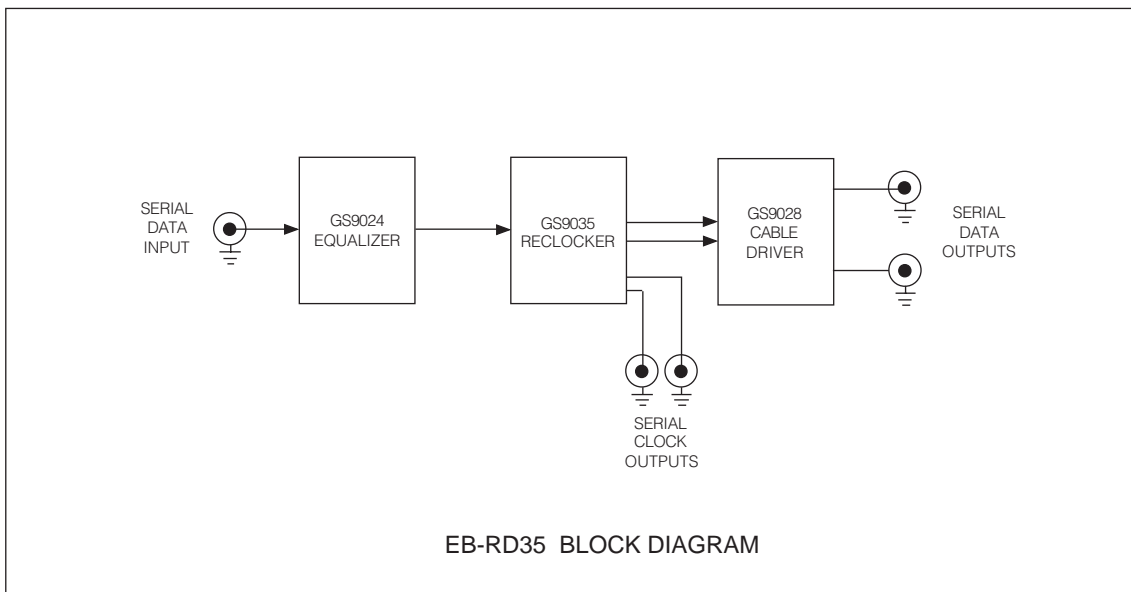

The CD_ADJ input of the GS9024 is biased via a resistor network including a potentiometer allowing the user to adjust the level at which loss of carrier is detected. For a detailed description of the CD_ADJ voltage level versus muting threshold refer to the GS9024 data sheet. Turning the potentiometer completely clockwise allows for maximum possible cable length equalization. In addition, the GS9024 outputs can be put in a HIGH-Z state by putting jumper JMP1 into the 1-2 position.

To verify operation of the EB-RD35, a source of serial digital video should be applied to the input BNC connector using 75Ω co-axial cable. Using a signal source that is not compliant to the SMPTE standards, can provide misleading results for equalizer cable length performance. The output data stream is available at the serial output and can be supplied to a D to A converter for verification via a monitor. Note that the jumpers should be set as shown below for an output to be present:

- JMP1: 2-3 (equalizer outputs enabled)
- JMP2: 1-2 (reclocker configured for AUTO mode)
- JMP3: 1-2 (reclocker configured for SMPTE mode)

The power supply requirement for the EB-RD35 is +5V for VCC at a current rating of 230mA (nominally).

PCB DETAILS

The EB-RD35 is a four layer printed circuit board constructed of standard FR-4 material and measures approximately 5" by 4.5". Ground and power plane layers are internal to the board with signal layers on the top and bottom of the board. Components are mounted both on the top and bottom sides. The silkscreen (top and bottom) and all four layers are shown on the following pages. Note the following special artwork features used to optimize performance:

- A continuous ground plane is provided underneath all high speed traces avoiding impedance discontinuities and ensuring maximum signal integrity
- Copper on the power and ground planes has been removed from the area surrounding the center pin of the output

BNC connectors and from underneath the output components of the GS9028 cable driver. The purpose of these cutouts is to reduce the effect of the capacitance added by the connector and the pads of the components.

- Copper on the power and ground planes has been removed from underneath the loop filter and RVCO components of the GS9035. The purpose of these cutouts is to avoid any noise coupling from the planes into the GS9035.

- The ground plane associated with the input BNC connector and input components is isolated from the main board ground. The purpose of this is to provide a differential input signal to the equalizer.

APPLICATIONS

The EB-RD35 evaluation board is designed to show the characteristics of the GS9024 Equalizer, the GS9035 Reclocker, and the GS9028 Cable Driver. This board can also be used as a stand alone reclocking distribution amplifier for serial digital video signals.

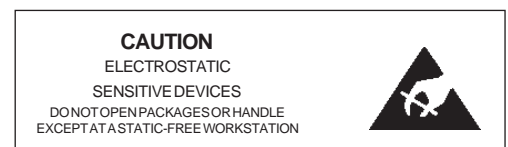

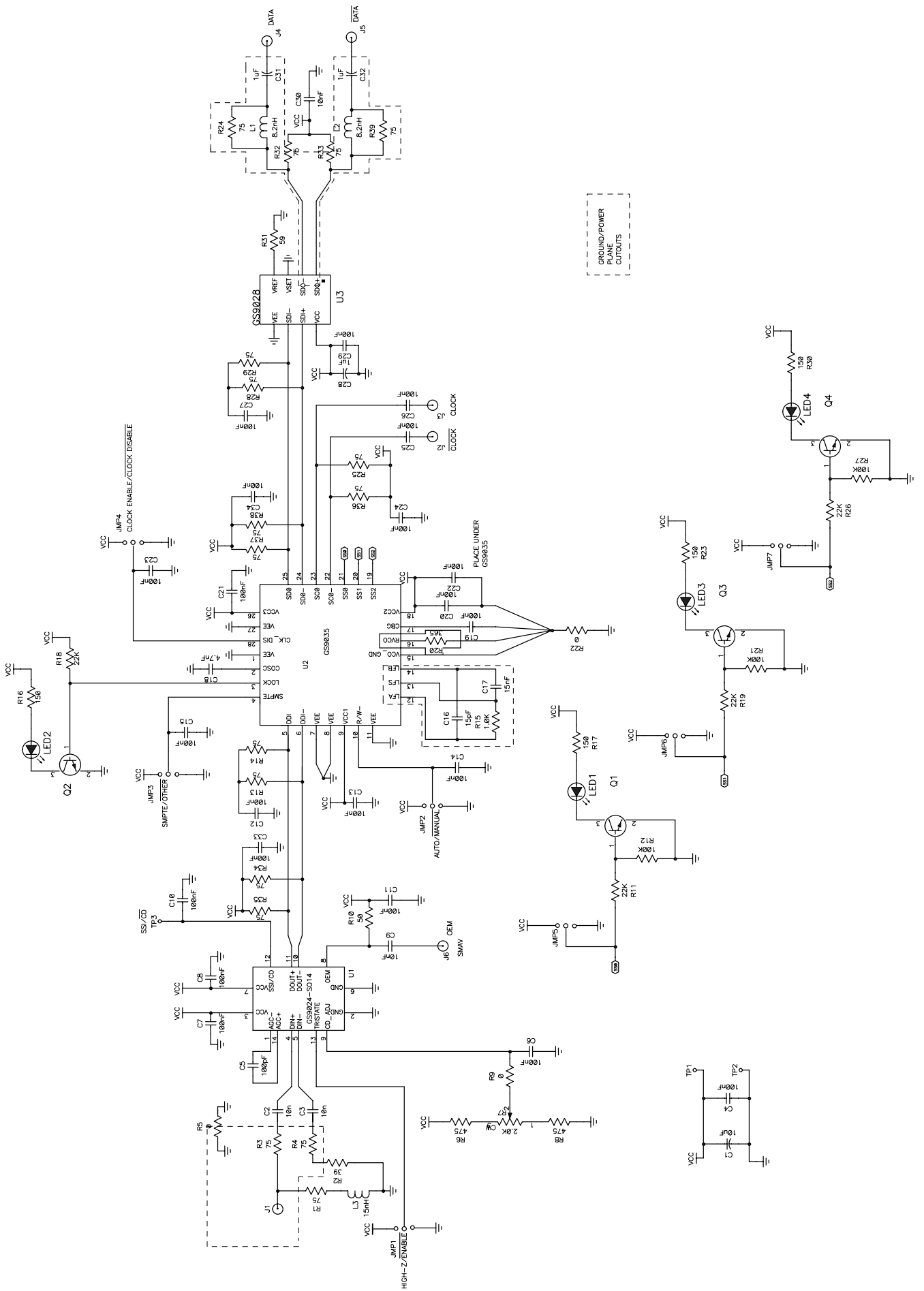



GENNUM
CORPORATION

EB-RD35

GENLINX™ II

**SDI ROUTING AND
DISTRIBUTION CHIPSET**

REV 2.1

LOCK Q2



R16 R18

SSI/CD



JMP1	1-2	2-3
JMP2	HIGH-Z	ENABLED
JMP3	AUTO	MANUAL
JMP4	SMPT E	OTHER
	CLOCK ENABLE	CLOCK DISABLE

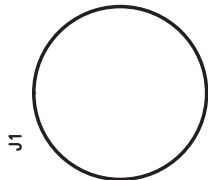

DATA IN

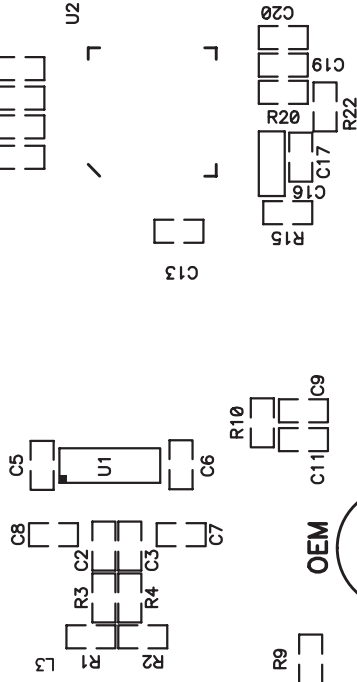

DATA OUT

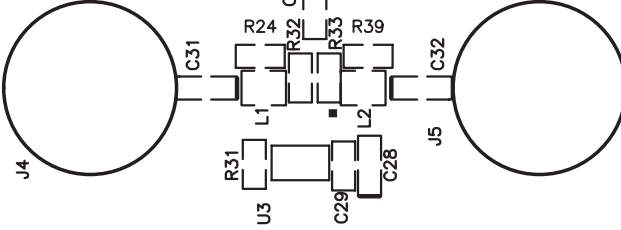

DATA OUT

DATA RATE INDICATION AUTO MODE, SMPT E=1			DATA RATE
SS2	SS1	SS0	143 Mbps
0	0	0	177 Mbps
0	1	0	270 Mbps
0	1	1	360 Mbps
1	0	0	540 Mbps

CLOCK OUT

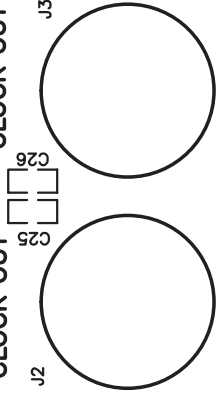

CLOCK OUT

