



1.0 PURPOSE

This document provides electrical characteristics of Intel's i960[®] CF embedded microprocessor. For functional descriptions consult the *i960[®] Cx Microprocessor User's Manual* (270710). To obtain data sheet updates and errata, contact Intel at any of the following numbers.

2.0 80960CF OVERVIEW

Intel's 80960CF is the second processor in the series of superscalar i960 microprocessors that also includes the 80960CA and the 80960HA/HD/HT. Upgrading from the 80960CA to the 80960CF is straightforward because the two processors are socket- and object code-compatible.

As shown in Figure 1, the 80960CF's instruction cache is 4 Kbytes; data cache is 1 Kbyte (80960CA instruction cache is 1 Kbyte; it does not have a data cache.) This extra cache on the CF adds a significant performance boost over the CA.

Intel's World-Wide Web (WWW) Location:	http://www.intel.com/
Customer Support (US and Canada):	800-628-8686
FaxBACK Service:	
<i>US and Canada</i>	800-628-2283
<i>Europe</i>	+44(0)793-496646
<i>worldwide</i>	916-356-3105
Application Bulletin Board Service:	
<i>up to 14.4-Kbaud line, worldwide</i>	916-356-3600
<i>dedicated 2400-baud line, worldwide</i>	916-356-7209
<i>Europe</i>	+44(0)793-496340

PRELIMINARY

1

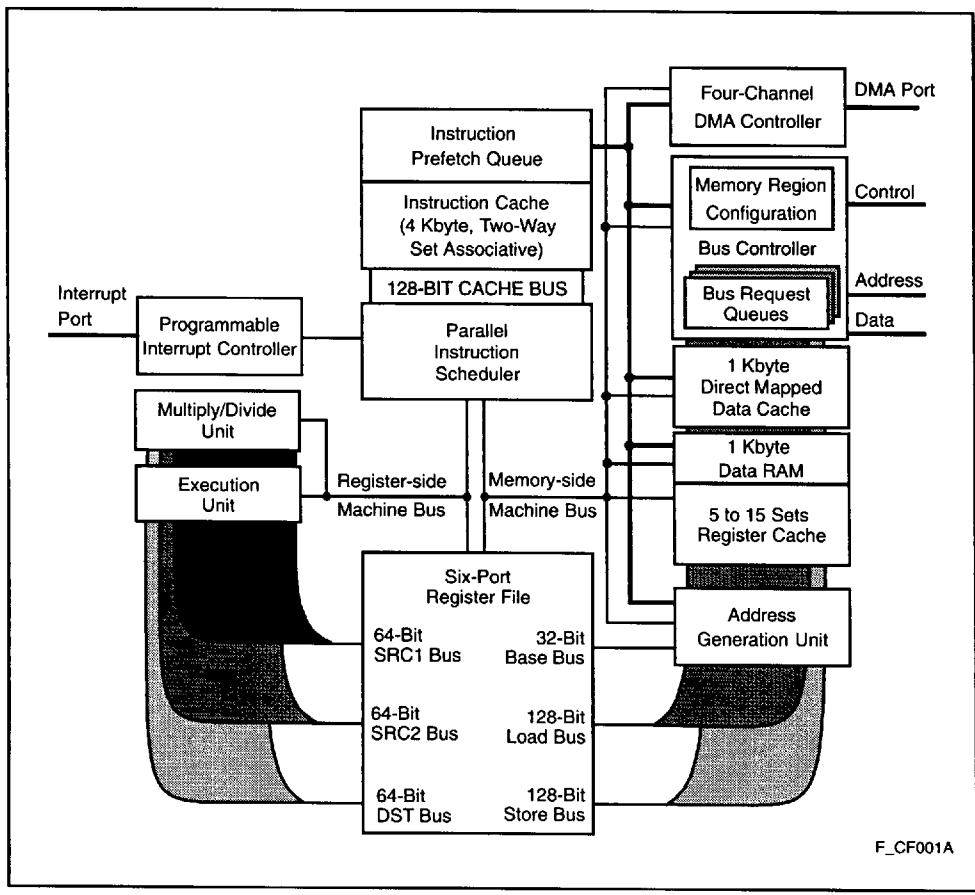

Figure 1. 80960CF Block Diagram

The 80960CF, object code compatible with the 32-bit 80960 core Architecture, employs Special Function Register extensions to control on-chip peripherals and instruction set extensions to shift 64-bit operands and configure on-chip hardware. Multiple 128-bit internal buses, on-chip instruction caching and a sophisticated instruction scheduler allow the processor to sustain execution of two instructions per clock with peak execution of three instructions per clock.

A 32-bit demultiplexed and pipelined burst bus provides a 132 Mbyte/s bandwidth to a system's

high-speed external memory subsystem. Also, the 80960CF's on-chip caching of instructions, procedure context and critical program data substantially decouples system performance from the wait states associated with accesses to the system's slower, cost sensitive, main memory subsystem.

The 80960CF bus controller integrates full wait state and bus width control for highest system performance with minimal system design complexity. Unaligned access and Big Endian byte order support reduces the cost of porting existing applications to the 80960CF.



The processor also integrates four complete data-chaining DMA channels and a high-speed interrupt controller on-chip. DMA channels perform single-cycle or two-cycle transfers, data packing and unpacking and data chaining. Block transfers — in addition to source or destination synchronized transfers — are supported.

The interrupt controller provides full programmability of 248 interrupt sources into 32 priority levels with a typical interrupt task switch (latency) time of 625 ns.

2.1 The 80960C-Series Core

The C-Series core is a very high performance microarchitectural implementation of the 80960 Core Architecture. This core can sustain execution of two instructions per clock (80 MIPS at 40 MHz). To achieve this level of performance, Intel has incorporated state-of-the-art silicon technology and innovative microarchitectural constructs into the C-Series core implementation. Factors that contribute to the core's performance include:

- Parallel instruction decoding allows issuance of up to three instructions per clock
- Single-clock execution of most instructions
- Parallel instruction decode allows sustained, simultaneous execution of two single-clock instructions every clock cycle
- Efficient instruction pipeline minimizes pipeline break losses
- Register and resource scoreboarding allow simultaneous multi-clock instruction execution
- Branch look-ahead and prediction allows many branches to execute with no pipeline break
- Local Register Cache integrated on-chip caches Call/Return context
- Two-way set associative, 4 Kbyte integrated instruction cache
- 1 Kbyte integrated Data RAM sustains a four-word (128-bit) access every clock cycle
- Direct mapped, 1 Kbyte data cache, write through, write allocate

2.2 Pipelined, Burst Bus

A 32-bit high performance bus controller interfaces the 80960CF to external memory and peripherals. The Bus Control Unit features a maximum transfer rate of 160 Mbytes per second (at 40 MHz). Internally programmable wait states and 16 separately configurable memory regions allow the processor to interface with a variety of memory subsystems with a minimum of system complexity and a maximum of performance. The Bus Control Unit's main features include:

- Demultiplexed, burst bus to exploit most efficient DRAM access modes
- Address pipelining to reduce memory cost while maintaining performance
- 32-, 16- and 8-bit modes for I/O interfacing ease
- Full internal wait state generation to reduce system cost
- Little and Big Endian support to ease application development
- Unaligned access support for code portability
- Three-deep request queue to decouple the bus from the core

2.3 Instruction Set Summary

Table 1 summarizes the 80960CF instruction set by logical groupings. See the *i960[®] Cx Microprocessor User's Manual (270710)* for a complete description of the instruction set.

2.4 Flexible DMA Controller

A four-channel DMA controller provides high speed DMA control for data transfers involving peripherals and memory. The DMA provides advanced features such as data chaining, byte assembly and disassembly and a high performance fly-by mode capable of transfer speeds of up to 71 Mbytes per second at 40 MHz. The DMA controller features a performance and flexibility which is only possible by integrating the DMA controller and the 80960CF core.

PRELIMINARY

3



2.5 Priority Interrupt Controller

A programmable-priority interrupt controller manages up to 248 external sources through the 8-bit external interrupt port. The Interrupt Unit also handles the four internal sources from the DMA controller and a single non-maskable interrupt input. The 8-bit interrupt port can also be configured to provide individual interrupt sources that are level or edge triggered.

80960CF interrupts are prioritized and signaled within 225 ns of the request. If the interrupt is of higher priority than the processor priority, the context switch to the interrupt routine typically completes in another 400 ns. The interrupt unit provides the mechanism for the low latency and high throughput interrupt service which is essential for embedded applications.

Table 1. 80960CF Instruction Set

Data Movement	Arithmetic	Logical	Bit / Bit Field / Byte
Load	Add	And	Set Bit
Store	Subtract	Not And	Clear Bit
Move	Multiply	And Not	Not Bit
Load Address	Divide	Or	Alter Bit
	Remainder	Exclusive Or	Scan For Bit
	Modulo	Not Or	Span Over Bit
	Shift	Or Not	Extract
	*Extended Shift	Nor	Modify
	Extended Multiply	Exclusive Nor	Scan Byte for Equal
	Extended Divide	Not	
	Add with Carry	Nand	
	Subtract with Carry		
	Rotate		
Comparison	Branch	Call/Return	Fault
Compare	Unconditional Branch	Call	Conditional Fault
Conditional Compare	Conditional Branch	Call Extended	Synchronize Faults
Compare and Increment	Compare and Branch	Call System	
Compare and Decrement		Return	
Test Condition Code		Branch and Link	
Check Bit			
Debug	Processor Mgmt	Atomic	
Modify Trace Controls	Flush Local Registers	Atomic Add	
Mark	Modify Arithmetic Controls	Atomic Modify	
Force Mark	Modify Process Controls		
	*System Control		
	*DMA Control		

NOTES: Instructions marked by (*) are 80960Cx extensions to the 80960 instruction set.



3.0 PACKAGE INFORMATION

3.1 Package Introduction

This section describes the pins, pinouts and thermal characteristics for the 80960CF in the 168-pin Ceramic Pin Grid Array (PGA) package; the 80960CF-33, -25, -16 devices are also available in the 196-pin Plastic Quad Flat Package (PQFP). For complete package specifications and information, see the *Packaging Handbook* (# 240800).

3.2 Pin Descriptions

This section defines the 80960CF pins. Table 2 presents the legend for interpreting the pin descriptions in the following tables. Pins associated with the 32-bit demultiplexed processor bus are described in Table 2. Pins associated with the 80960CF DMA Controller and Interrupt Unit are described in Table 3. Pins associated with basic processor configuration and control are described in Table 2.

All pins float while the processor is in the ONCE mode.

Symbol	Description
I	Input only pin
O	Output only pin
I/O	Pin can be either an input or output
-	Pins "must be" connected as described
S(...)	Synchronous. Inputs must meet setup and hold times relative to PCLK2:1 for proper operation. Outputs are synchronous to PCLK2:1. S(E) Edge sensitive input S(L) Level sensitive input
A(...)	Asynchronous. Inputs may be asynchronous to PCLK2:1. A(E) Edge sensitive input A(L) Level sensitive input
H(...)	While the bus is in the Hold Acknowledge or Bus Backoff state, the pin: H(1) is driven to V _{CC} H(0) is driven to V _{SS} H(Z) floats H(Q) continues to be a valid input
R(...)	While the processor's RESET pin is low, the pin: R(1) is driven to V _{CC} R(0) is driven to V _{SS} R(Z) floats R(Q) continues to be a valid output



Table 2. 80960CF Pin Description — External Bus Signals (Sheet 1 of 3)

Name	Type	Description																																				
A31:2	O S H(Z) R(Z)	ADDRESS BUS carries the physical address' upper 30 bits. A31 is the most significant bit; A2 is least significant. During a bus access, A31:2 identify all external addresses to word (4-byte) boundaries. Byte enable signals indicate the selected byte in each word. During burst accesses, A3:2 increment to indicate successive data cycles.																																				
D31:0	I/O S(L) H(Z) R(Z)	DATA BUS carries 32-, 16- or 8-bit data quantities depending on bus width configuration. The least significant bit is carried on D0 and the most significant on D31. When the bus is configured for 8-bit data, the lower 8 data lines, D7:0 are used. For 16-bit data bus widths, D15:0 are used. For 32-bit bus widths the full data bus is used.																																				
BE3:0	O S H(Z) R(1)	<p>BYTE ENABLES select which of the four bytes addressed by A31:2 are active during an access to a memory region configured for a 32-bit data-bus width. $\overline{BE3}$ applies to D31:24; $\overline{BE2}$ applies to D23:16; $\overline{BE1}$ applies to D15:8 $\overline{BE0}$ applies to D7:0.</p> <p>32-bit bus:</p> <table border="0"> <tr> <td>$\overline{BE3}$</td> <td>Byte Enable 3</td> <td>enable D31:24</td> </tr> <tr> <td>$\overline{BE2}$</td> <td>Byte Enable 2</td> <td>enable D23:16</td> </tr> <tr> <td>$\overline{BE1}$</td> <td>Byte Enable 1</td> <td>enable D15:8</td> </tr> <tr> <td>$\overline{BE0}$</td> <td>Byte Enable 0</td> <td>enable D7:0</td> </tr> </table> <p>For accesses to a memory region configured for a 16-bit data-bus width, the processor uses the $\overline{BE3}$, $\overline{BE1}$ and $\overline{BE0}$ pins as \overline{BHE}, A1 and \overline{BLE} respectively.</p> <p>16-bit bus:</p> <table border="0"> <tr> <td>$\overline{BE3}$</td> <td>Byte High Enable (\overline{BHE})</td> <td>enable D15:8</td> </tr> <tr> <td>$\overline{BE2}$</td> <td>Not used (driven high or low)</td> <td></td> </tr> <tr> <td>$\overline{BE1}$</td> <td>Address Bit 1 (A1)</td> <td></td> </tr> <tr> <td>$\overline{BE0}$</td> <td>Byte Low Enable (\overline{BLE})</td> <td>enable D7:0</td> </tr> </table> <p>For accesses to a memory region configured for an 8-bit data-bus width, the processor uses the $\overline{BE1}$ and $\overline{BE0}$ pins as A1 and A0 respectively.</p> <p>8-bit bus:</p> <table border="0"> <tr> <td>$\overline{BE3}$</td> <td>Not used (driven high or low)</td> <td></td> </tr> <tr> <td>$\overline{BE2}$</td> <td>Not used (driven high or low)</td> <td></td> </tr> <tr> <td>$\overline{BE1}$</td> <td>Address Bit 1 (A1)</td> <td></td> </tr> <tr> <td>$\overline{BE0}$</td> <td>Address Bit 0 (A0)</td> <td></td> </tr> </table>	$\overline{BE3}$	Byte Enable 3	enable D31:24	$\overline{BE2}$	Byte Enable 2	enable D23:16	$\overline{BE1}$	Byte Enable 1	enable D15:8	$\overline{BE0}$	Byte Enable 0	enable D7:0	$\overline{BE3}$	Byte High Enable (\overline{BHE})	enable D15:8	$\overline{BE2}$	Not used (driven high or low)		$\overline{BE1}$	Address Bit 1 (A1)		$\overline{BE0}$	Byte Low Enable (\overline{BLE})	enable D7:0	$\overline{BE3}$	Not used (driven high or low)		$\overline{BE2}$	Not used (driven high or low)		$\overline{BE1}$	Address Bit 1 (A1)		$\overline{BE0}$	Address Bit 0 (A0)	
$\overline{BE3}$	Byte Enable 3	enable D31:24																																				
$\overline{BE2}$	Byte Enable 2	enable D23:16																																				
$\overline{BE1}$	Byte Enable 1	enable D15:8																																				
$\overline{BE0}$	Byte Enable 0	enable D7:0																																				
$\overline{BE3}$	Byte High Enable (\overline{BHE})	enable D15:8																																				
$\overline{BE2}$	Not used (driven high or low)																																					
$\overline{BE1}$	Address Bit 1 (A1)																																					
$\overline{BE0}$	Byte Low Enable (\overline{BLE})	enable D7:0																																				
$\overline{BE3}$	Not used (driven high or low)																																					
$\overline{BE2}$	Not used (driven high or low)																																					
$\overline{BE1}$	Address Bit 1 (A1)																																					
$\overline{BE0}$	Address Bit 0 (A0)																																					
W/R	O S H(Z) R(0)	WRITE/READ is asserted for read requests and deasserted for write requests. The W/R signal changes in the same clock cycle as \overline{ADS} . It remains valid for the entire access in non-pipelined regions. In pipelined regions, W/R is not guaranteed to be valid in the last cycle of a read access.																																				
ADS	O S H(Z) R(1)	ADDRESS STROBE indicates a valid address and the start of a new bus access. \overline{ADS} is asserted for the first clock of a bus access.																																				
READY	I S(L) H(Z) R(Z)	READY is an input which signals the termination of a data transfer. \overline{READY} is used to indicate that read data on the bus is valid or that a write-data transfer has completed. The \overline{READY} signal works in conjunction with the internally programmed wait-state generator. If \overline{READY} is enabled in a region, the pin is sampled after the programmed number of wait-states has expired. If the \overline{READY} pin is deasserted, wait states continue to be inserted until \overline{READY} becomes asserted. This is true for the N_{RAD} , N_{RDD} , N_{WAD} and N_{WDD} wait states. The N_{XDA} wait states cannot be extended.																																				



Table 2. 80960CF Pin Description — External Bus Signals (Sheet 2 of 3)

Name	Type	Description
BTERM	I S(L) H(Z) R(Z)	BURST TERMINATE is an input which breaks up a burst access and causes another address cycle to occur. The BTERM signal works in conjunction with the internally programmed wait-state generator. If READY and BTERM are enabled in a region, the BTERM pin is sampled after the programmed number of wait states has expired. When BTERM is asserted, a new ADS signal is generated and the access is completed. The READY input is ignored when BTERM is asserted. BTERM must be externally synchronized to satisfy BTERM setup and hold times.
WAIT	O S H(Z) R(1)	WAIT indicates internal wait state generator status. WAIT is asserted when wait states are being caused by the internal wait state generator and not by the READY or BTERM inputs. WAIT can be used to derive a write-data strobe. WAIT can also be thought of as a READY output that the processor provides when it is inserting wait states.
BLAST	O S H(Z) R(0)	BURST LAST indicates the last transfer in a bus access. BLAST is asserted in the last data transfer of burst and non-burst accesses after the wait state counter reaches zero. BLAST remains asserted until the clock following the last cycle of the last data transfer of a bus access. If the READY or BTERM input is used to extend wait states, the BLAST signal remains asserted until READY or BTERM terminates the access.
DT/R	O S H(Z) R(0)	DATA TRANSMIT/RECEIVE indicates direction for data transceivers. DT/R is used in conjunction with DEN to provide control for data transceivers attached to the external bus. When DT/R is asserted, the signal indicates that the processor receives data. Conversely, when deasserted, the processor sends data. DT/R changes only while DEN is high.
DEN	O S H(Z) R(1)	DATA ENABLE indicates data cycles in a bus request. DEN is asserted at the start of the bus request first data cycle and is deasserted at the end of the last data cycle. DEN is used in conjunction with DT/R to provide control for data transceivers attached to the external bus. DEN remains asserted for sequential reads from pipelined memory regions. DEN is deasserted when DT/R changes.
LOCK	O S H(Z) R(1)	BUS LOCK indicates that an atomic read-modify-write operation is in progress. LOCK may be used to prevent external agents from accessing memory which is currently involved in an atomic operation. LOCK is asserted in the first clock of an atomic operation and deasserted in the clock cycle following the last bus access for the atomic operation. To allow the most flexibility for memory system enforcement of locked accesses, the processor acknowledges a bus hold request when LOCK is asserted. The processor performs DMA transfers while LOCK is active.
HOLD	I S(L) H(Z) R(Z)	HOLD REQUEST signals that an external agent requests access to the external bus. The processor asserts HOLDA after completing the current bus request. HOLD , HOLDA and BREQ are used together to arbitrate access to the processor's external bus by external bus agents.
BOFF	I S(L) H(Z) R(Z)	BUS BACKOFF , when asserted, suspends the current access and causes the bus pins to float. When BOFF is deasserted, the ADS signal is asserted on the next clock cycle and the access is resumed.



Table 2. 80960CF Pin Description — External Bus Signals (Sheet 3 of 3)

Name	Type	Description
HOLDA	O S H(1) R(Q)	HOLD ACKNOWLEDGE indicates to a bus requestor that the processor has relinquished control of the external bus. When HOLDA is asserted, the external address bus, data bus and bus control signals are floated. HOLD , $\overline{\text{BOFF}}$, HOLDA and BREQ are used together to arbitrate access to the processor's external bus by external bus agents. Since the processor grants HOLD requests and enters the Hold Acknowledge state even while RESET is asserted, the state of the HOLDA pin is independent of the RESET pin.
BREQ	O S H(Q) R(O)	BUS REQUEST is asserted when the bus controller has a request pending. BREQ can be used by external bus arbitration logic in conjunction with HOLD and HOLDA to determine when to return mastership of the external bus to the processor.
D/C	O S H(Z) R(Z)	DATA OR CODE is asserted for a data request and deasserted for instruction requests. $\overline{\text{D/C}}$ has the same timing as W/R .
DMA	O S H(Z) R(Z)	DMA ACCESS indicates whether the bus request was initiated by the DMA controller. DMA is asserted for any DMA request. DMA is deasserted for all other requests.
SUP	O S H(Z) R(Z)	SUPERVISOR ACCESS indicates whether the bus request is issued while in supervisor mode. SUP is asserted when the request has supervisor privileges and is deasserted otherwise. SUP can be used to isolate supervisor code and data structures from non-supervisor requests.

Table 3. 80960CF Pin Description — Processor Control Signals (Sheet 1 of 2)

Name	Type	Description
RESET	I A(L) H(Z) R(Z)	<p>RESET causes the chip to reset. When RESET is asserted, all external signals return to the reset state. When RESET is deasserted, initialization begins. When the 2-x clock mode is selected, RESET must remain asserted for 32 CLKIN cycles before being deasserted to guarantee correct processor initialization. When the 1-x clock mode is selected, RESET must remain asserted for 10,000 CLKIN cycles before being deasserted to guarantee correct processor initialization. The CLKMODE pin selects 1-x or 2-x input clock division of the CLKIN pin.</p> <p>The Hold Acknowledge bus state functions while the chip is reset. If the bus is in the Hold Acknowledge state when RESET is asserted, the processor internally resets, but maintains the Hold Acknowledge state on external pins until the Hold request is removed. If a Hold request is made while the processor is in the reset state, the processor bus grants HOLDA and enters the Hold Acknowledge state.</p>
FAIL	O S H(Q) R(O)	<p>FAIL indicates failure of the self-test performed at initialization. When RESET is deasserted and initialization begins, the FAIL pin is asserted. An internal self-test is performed as part of the initialization process. If this self-test passes, the FAIL pin is deasserted; otherwise it remains asserted. The FAIL pin is reasserted while the processor performs an external bus self-confidence test. If this self-test passes, the processor deasserts the FAIL pin and branches to the user's initialization routine; otherwise the FAIL pin remains asserted. Internal self-test and the use of the FAIL pin can be disabled with the STEST pin.</p>
STEST	I S(L) H(Z) R(Z)	<p>SELF TEST enables or disables the internal self-test feature at initialization. STEST is read on the rising edge of RESET. When asserted, internal self-test and external bus confidence tests are performed during processor initialization. When deasserted, only the bus confidence tests are performed during initialization.</p>
ONCE	I A(L) H(Z) R(Z)	<p>ON CIRCUIT EMULATION, when asserted, causes all outputs to be floated. ONCE is continuously sampled while RESET is low and is latched on the rising edge of RESET. To place the processor in the ONCE state:</p> <ol style="list-style-type: none"> (1) assert RESET and ONCE (order does not matter) (2) wait for at least 16 CLKIN periods in 2-x mode—or 10,000 CLKIN periods in 1-x mode—after V_{CC} and CLKIN are within operating specifications (3) deassert RESET (4) wait at least 32 CLKIN periods <p>(The processor will now be latched in the ONCE state while RESET is high.)</p> <p>To exit the ONCE state, bring V_{CC} and CLKIN to operating conditions, then assert RESET and bring ONCE high prior to deasserting RESET.</p> <p>CLKIN must operate within the specified operating conditions until Step 4 completes. CLKIN may then be changed to DC to achieve the lowest possible ONCE mode leakage current.</p> <p>ONCE can be used by emulator products or board testers to effectively make an installed processor transparent in the board.</p>



Table 3. 80960CF Pin Description — Processor Control Signals (Sheet 2 of 2)

Name	Type	Description
CLKIN	I A(E) H(Z) R(Z)	CLOCK INPUT is an input for the external clock needed to run the processor. The external clock is internally divided as prescribed by the CLKMODE pin to produce PCLK2:1.
CLKMODE	I A(L) H(Z) R(Z)	CLOCK MODE selects the division factor applied to the external clock input (CLKIN). When CLKMODE is high, CLKIN is divided by one to create PCLK2:1 and the processor's internal clock. When CLKMODE is low, CLKIN is divided by two to create PCLK2:1 and the processor's internal clock. CLKMODE should be tied high or low in a system as the clock mode is not latched by the processor. If left unconnected, the processor internally pulls the CLKMODE pin low, enabling the 2-x clock mode.
PCLK2:1	O S H(Q) R(Q)	PROCESSOR OUTPUT CLOCKS provide a timing reference for all inputs and outputs. All input and output timings are specified in relation to PCLK2 and PCLK1. PCLK2 and PCLK1 are identical signals. Two output pins are provided to allow flexibility in the system's allocation of capacitive loading on the clock. PCLK2:1 may also be connected at the processor to form a single clock signal.
V _{SS}	—	GROUND connections must be connected externally to a V _{SS} board plane.
V _{CC}	—	POWER connections must be connected externally to a V _{CC} board plane.
V _{CCPLL}	—	V _{CCPLL} is a separate V _{CC} supply pin for the phase lock loop used in 1-x clock mode. Connecting a simple lowpass filter to V _{CCPLL} may help reduce clock jitter (T _{CP}) in noisy environments. Otherwise, V _{CCPLL} should be connected to V _{CC} .
NC	—	NO CONNECT pins must not be connected in a system.

Table 4. 80960CF Pin Description — DMA and Interrupt Unit Control Signals

Name	Type	Description
DREQ3:0	I A(L) H(Z) R(Z)	DMA REQUEST is used to request a DMA transfer. Each of the four signals requests a transfer on a single channel. DREQ0 requests channel 0, DREQ1 requests channel 1, etc. When two or more channels are requested simultaneously, the channel with the highest priority is serviced first. Channel priority mode is programmable.
DACK3:0	O S H(1) R(1)	DMA ACKNOWLEDGE indicates that a DMA transfer is being executed. Each of the four signals acknowledges a transfer for a single channel. DACK0 acknowledges channel 0, DACK1 acknowledges channel 1, etc. DACK3:0 are asserted when the requesting device of a DMA is accessed.
EOP/TC3:0	I/O A(L) H(Z/Q) R(Z)	END OF PROCESS/TERMINAL COUNT can be programmed as either an input (EOP3:0) or output (TC3:0), but not both. Each pin is individually programmable. When programmed as an input, EOPx causes termination of a current DMA transfer for the channel that corresponds to the EOPx pin. EOP0 corresponds to channel 0, EOP1 corresponds to channel 1, etc. When a channel is configured for source <i>and</i> destination chaining, the EOP pin for that channel causes termination of only the current buffer transferred and causes the next buffer to be transferred. EOP3:0 are asynchronous inputs. When programmed as an output, the channel's TCx pin indicates that the channel byte count has reached 0 and a DMA has terminated. TCx is driven with the same timing as DACKx during the last DMA transfer for a buffer. If the last bus request is executed as multiple bus accesses, TCx stays asserted for the entire bus request.
XINT7:0	I A(E/L) H(Z) R(Z)	EXTERNAL INTERRUPT PINS cause interrupts to be requested. These pins can be configured in three modes: Dedicated Mode: each pin is a dedicated external interrupt source. Dedicated inputs can be individually programmed to be level (low) or edge (falling) activated. Expanded Mode: the eight pins act together as an 8-bit vectored interrupt source. The interrupt pins in this mode are level activated. Since the interrupt pins are active low, the vector number requested is the 1's complement of the positive logic value place on the port. This eliminates glue logic to interface to combinational priority encoders which output negative logic. Mixed Mode: XINT7:5 are dedicated sources and XINT4:0 act as the five most significant bits of an expanded mode vector. The least significant bits are set to 010 internally.
NMI	I A(E) H(Z) R(Z)	NON-MASKABLE INTERRUPT causes a non-maskable interrupt event to occur. NMI is the highest priority interrupt recognized. NMI is an edge (falling) activated source.



3.3 80960CF Mechanical Data

80960CF PGA pinout as viewed from the pin-side of the package (i.e., pins facing up).

3.3.1 80960CF PGA PINOUT

Figure 2 depicts the complete 80960CF PGA pinout as viewed from the top side of the component (i.e., pins facing down).

Table 5 lists the 80960CF pin names and package location in signal order; Table 6 lists the pin names and package location in pin order. See **Section 4.0, ELECTRICAL SPECIFICATIONS** for specifications and recommended connections.

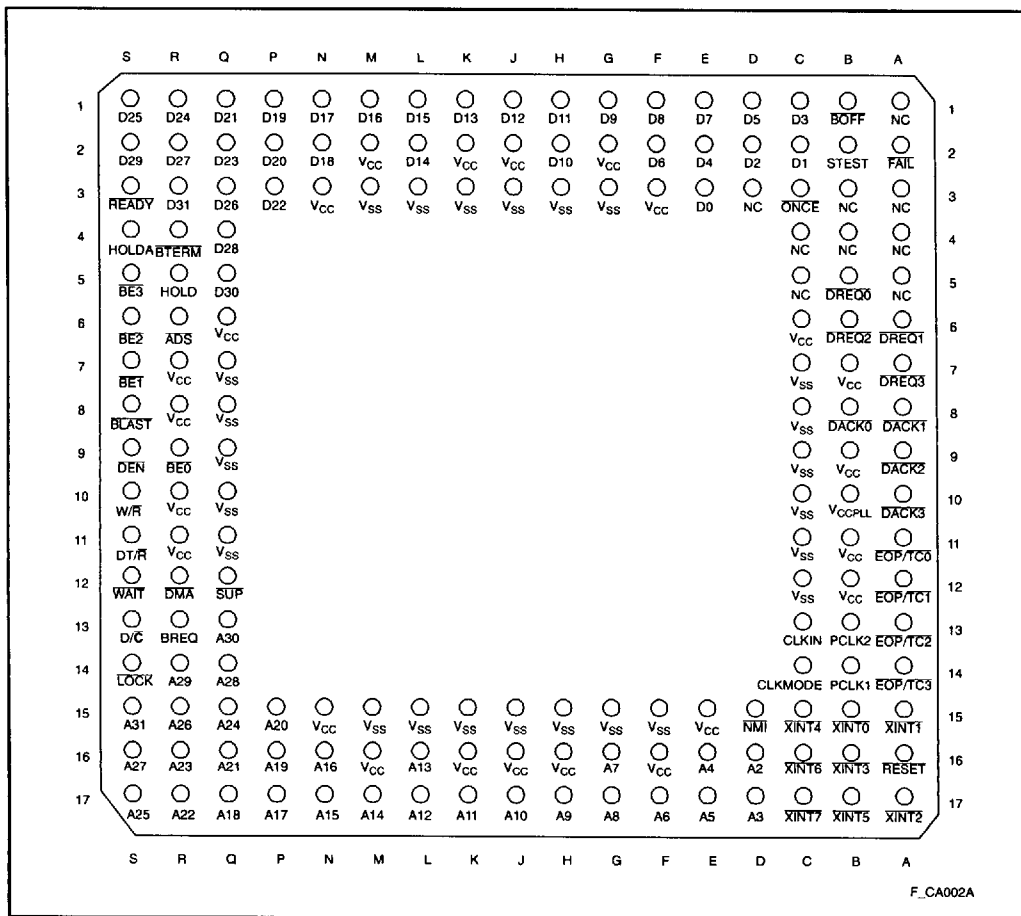

Figure 2. 80960CF PGA Pinout—View from Top (Pins Facing Down)

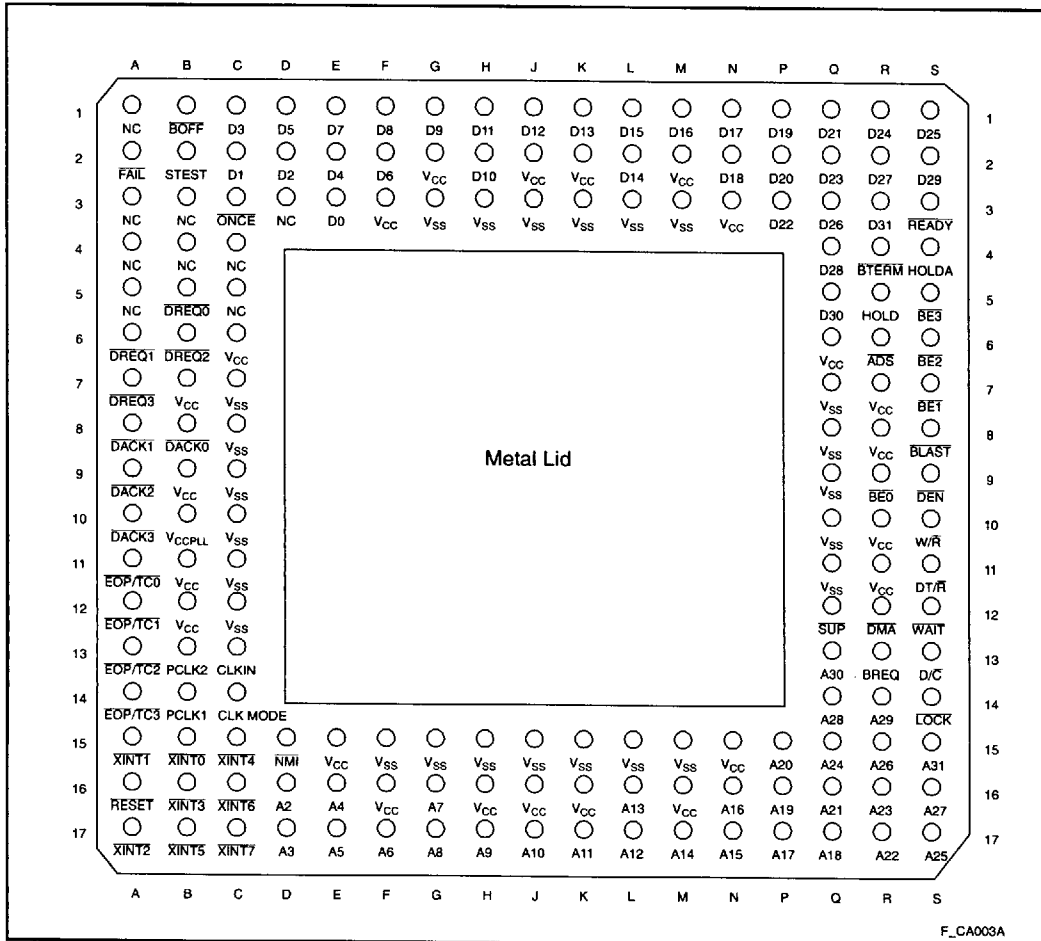

Figure 3. 80960CF PGA Pinout — View from Bottom (Pins Facing Up)



Table 5. 80960CF PGA Pinout — In Signal Order

Address Bus		Data Bus		Bus Control		Processor Control		I/O	
Signal	Pin	Signal	Pin	Signal	Pin	Signal	Pin	Signal	Pin
A31	S15	D31	R3	BE ₃	S5	RESET	A16	DREQ ₃	A7
A30	Q13	D30	Q5	BE ₂	S6			DREQ ₂	B
A29	R14	D29	S2	BE ₁	S7	FAIL	A2	DREQ ₁	A6
A28	Q14	D28	Q4	BE ₀	R9			DREQ ₀	B
A27	S16	D27	R2			STEST	B2		
A26	R15	D26	Q3	W/R	S10			DACK ₃	A1
A25	S17	D25	S1			ONCE	C3	DACK ₂	A9
A24	Q15	D24	R1	ADS	R6			DACK ₁	A
A23	R16	D23	Q2			CLKIN	C13	DACK ₀	B8
A22	R17	D22	P3	READY	S3	CLKMODE	C14		
A21	Q16	D21	Q1	BTERM	R4	PLCK1	B14	EOP/TC ₃	A14
A20	P15	D20	P2			PLCK2	B13	EOP/TC ₂	A13
A19	P16	D19	P1	WAIT	S12			EOP/TC ₁	A12
A18	Q17	D18	N2	BLAST	S8	V _{SS}		EOP/TC ₀	A11
A17	P17	D17	N1			Location			
A16	N16	D16	M1	DT/R	S11	C7, C8, C9, C10, C11, C12, F15, G3, G15, H3, H15, J3, J15, K3, K15, L3, L15, M3, M15, Q7, Q8, Q9, Q10, Q11		XINT ₇	C17
A15	N17	D15	L1	DEN	S9			XINT ₆	C16
A14	M17	D14	L2					XINT ₅	B17
A13	L16	D13	K1	LOCK	S14			XINT ₄	C15
A12	L17	D12	J1					XINT ₃	B16
A11	K17	D11	H1			V _{CC}		XINT ₂	A17
A10	J17	D10	H2	HOLD	R5	Location		XINT ₁	A15
A9	H17	D9	G1	HOLDA	S4	B7, B9, B11, B12, C6, E15, F3, F16, G2, H16, J2, J16, K2, K16, M2, M16, N3, N15, Q6, R7, R8, R10, R11		XINT ₀	B15
A8	G17	D8	F1	BREQ	R13				
A7	G16	D7	E1					NMI	D15
A6	F17	D6	F2	D/C	S13				
A5	E17	D5	D1	DMA	R12				
A4	E16	D4	E2	SUP	Q12	V _{CCPLL}	B10		
A3	D17	D3	C1			No Connect			
A2	D16	D2	D2	BOFF	B1	Location			
		D1	C2			A1, A3, A4, A5, B3, B4, C4, C5, D3			
		D0	E3						



Table 6. 80960CF PGA Pinout — In Pin Order

Pin	Signal	Pin	Signal	Pin	Signal	Pin	Signal	Pin	Signal
A1	NC	C1	D3	F17	A6	M15	V _{SS}	R3	D31
A2	FAIL	C2	D1	G1	D9	M16	V _{CC}	R4	BTERM
A3	NC	C3	ONCE	G2	V _{CC}	M17	A14	R5	HOLD
A4	NC	C4	NC	G3	V _{SS}	N1	D17	R6	ADS
A5	NC	C5	NC	G15	V _{SS}	N2	D18	R7	V _{CC}
A6	DREQ1	C6	V _{CC}	G16	A7	N3	V _{CC}	R8	V _{CC}
A7	DREQ3	C7	V _{SS}	G17	A8	N15	V _{CC}	R9	BE0
A8	DACK1	C8	V _{SS}	H1	D11	N16	A16	R10	V _{CC}
A9	DACK2	C9	V _{SS}	H2	D10	N17	A15	R11	V _{CC}
A10	DACK3	C10	V _{SS}	H3	V _{SS}	P1	D19	R12	DMA
A11	EOP/TC0	C11	V _{SS}	H15	V _{SS}	P2	D20	R13	BREQ
A12	EOP/TC1	C12	V _{SS}	H16	V _{CC}	P3	D22	R14	A29
A13	EOP/TC2	C13	CLKIN	H17	A9	P15	A20	R15	A26
A14	EOP/TC3	C14	CLKMODE	J1	D12	P16	A19	R16	A23
A15	XINT1	C15	XINT4	J2	V _{CC}	P17	A17	R17	A22
A16	RESET	C16	XINT6	J3	V _{SS}	Q1	D21	S1	D25
A17	XINT2	C17	XINT7	J15	V _{SS}	Q2	D23	S2	D29
B1	BOFF	D1	D5	J16	V _{CC}	Q3	D26	S3	READY
B2	STEST	D2	D2	J17	A10	Q4	D28	S4	HOLDA
B3	NC	D3	NC	K1	D13	Q5	D30	S5	BE3
B4	NC	D15	NMI	K2	V _{CC}	Q6	V _{CC}	S6	BE2
B5	DREQ0	D16	A2	K3	V _{SS}	Q7	V _{SS}	S7	BE1
B6	DREQ2	D17	A3	K15	V _{SS}	Q8	V _{SS}	S8	BLAST
B7	V _{CC}	E1	D7	K16	V _{CC}	Q9	V _{SS}	S9	DEN
B8	DACK0	E2	D4	K17	A11	Q10	V _{SS}	S10	W/R
B9	V _{CC}	E3	D0	L1	D15	Q11	V _{SS}	S11	DT/R
B10	V _{CCPLL}	E15	V _{CC}	L2	D14	Q12	SUP	S12	WAIT
B11	V _{CC}	E16	A4	L3	V _{SS}	Q13	A30	S13	D/C
B12	V _{CC}	E17	A5	L15	V _{SS}	Q14	A28	S14	LOCK
B13	PCLK2	F1	D8	L16	A13	Q15	A24	S15	A31
B14	PCLK1	F2	D6	L17	A12	Q16	A21	S16	A27
B15	XINT0	F3	V _{CC}	M1	D16	Q17	A18	S17	A25
B16	XINT3	F15	V _{SS}	M2	V _{CC}	R1	D24		
B17	XINT5	F16	V _{CC}	M3	V _{SS}	R2	D27		

PRELIMINARY

80960CF-40, -33, -25, -16



3.3.2 80960CF PQFP Pinout (80960CF-33, -25, -16 Only)

Tables 7 and 8 list the 80960CF pin names with package location. Figure 4 shows the 80960CF PQFP pinout as viewed from the top side. See **Section 4.0, ELECTRICAL SPECIFICATIONS** for specifications and recommended connections.



Table 7. 80960CF PQFP Pinout — In Signal Order (80960CF-33, -25, -16 Only)

Address Bus		Data Bus		Bus Control		Processor Control		I/O		
Signal	Pin	Signal	Pin	Signal	Pin	Signal	Pin	Signal	Pin	
A31	153	D31	186	BE3	176	RESET	91	DREQ3	60	
A30	152	D30	187	BE2	175	FAIL	45	DREQ2	59	
A29	151	D29	188	BE1	172	STEST	46	DREQ1	58	
A28	145	D28	189	BE0	170	ONCE	43	DREQ0	57	
A27	144	D27	191			CLKIN	87			
A26	143	D26	192	W/R	164	CLKMODE	85	DACK3	65	
A25	142	D25	194			PCLK2	74	DACK2	64	
A24	141	D24	195	ADS	178	PCLK1	78	DACK1	63	
A23	139	D23	3			V _{SS}		DACK0	62	
A22	138	D22	4	READY	182	Location				
A21	137	D21	5	BTERM	184	2, 7, 16, 24, 30, 38, 39, 49, 56, 70, 75, 77, 81, 83, 88, 89, 92, 98, 105, 109, 110, 121, 125, 131, 135, 147, 150, 161, 165, 173, 174, 185, 196		EOP/TC3	69	
A20	136	D20	6						EOP/TC2	68
A19	134	D19	8	WAIT	162				EOP/TC1	67
A18	133	D18	9	BLAST	169				EOP/TC0	66
A17	132	D17	10							
A16	130	D16	11	DT/R	163			XINT7	10	
A15	129	D15	13	DEN	167	V _{CC}		XINT6	106	
A14	128	D14	14			Location		XINT5	102	
A13	124	D13	15	LOCK	156	1, 12, 20, 28, 32, 37, 44, 50, 61, 71, 79, 82, 96, 99, 103, 115, 127, 140, 148, 154, 168, 171, 180, 190		XINT4	101	
A12	123	D12	17						XINT3	100
A11	122	D11	18	HOLD	181				XINT2	95
A10	120	D10	19	HOLDA	179				XINT1	94
A9	119	D9	21	BREQ	155			XINT0	93	
A8	118	D8	22			V _{CCPLL}	72			
A7	117	D7	23	D/C	159	No Connect		NMI	108	
A6	116	D6	25	DMA	160	Location				
A5	114	D5	26	SUP	158	29, 31, 41, 42, 47, 48, 51, 52, 53, 54, 55, 73, 76, 80, 84, 86, 90, 97, 104, 126, 146, 149, 157, 166, 177, 183, 193				
A4	113	D4	27							
A3	112	D3	33	BOFF	40					
A2	111	D2	34							
		D1	35							
		D0	36							

PRELIMINARY



Table 8. 80960CF PQFP Pinout — In Pin Order (80960CF-33, -25, -16 Only)

Pin	Signal	Pin	Signal	Pin	Signal	Pin	Signal	Pin	Signal	Pin	Signal
1	V _{CC}	34	D2	67	EOP/TC1	100	XINT3	133	A18	166	NC
2	V _{SS}	35	D1	68	EOP/TC2	101	XINT4	134	A19	167	DEN
3	D23	36	D0	69	EOP/TC3	102	XINT5	135	V _{SS}	168	V _{CC}
4	D22	37	V _{CC}	70	V _{SS}	103	V _{CC}	136	A20	169	BLAST
5	D21	38	V _{SS}	71	V _{CC}	104	NC	137	A21	170	BE0
6	D20	39	V _{SS}	72	V _{CCPLL}	105	V _{SS}	138	A22	171	V _{CC}
7	V _{SS}	40	BOFF	73	NC	106	XINT6	139	A23	172	BE1
8	D19	41	NC	74	PCLK2	107	XINT7	140	V _{CC}	173	V _{SS}
9	D18	42	NC	75	V _{SS}	108	NMI	141	A24	174	V _{SS}
10	D17	43	ONCE	76	NC	109	V _{SS}	142	A25	175	BE2
11	D16	44	V _{CC}	77	V _{SS}	110	V _{SS}	143	A26	176	BE3
12	V _{CC}	45	FAIL	78	PCLK1	111	A2	144	A27	177	NC
13	D15	46	STEST	79	V _{CC}	112	A3	145	A28	178	ADS
14	D14	47	NC	80	NC	113	A4	146	NC	179	HOLDA
15	D13	48	NC	81	V _{SS}	114	A5	147	V _{SS}	180	V _{CC}
16	V _{SS}	49	V _{SS}	82	V _{CC}	115	V _{CC}	148	V _{CC}	181	HOLD
17	D12	50	V _{CC}	83	V _{SS}	116	A6	149	NC	182	READY
18	D11	51	NC	84	NC	117	A7	150	V _{SS}	183	NC
19	D10	52	NC	85	CLKMODE	118	A8	151	A29	184	BTERM
20	V _{CC}	53	NC	86	NC	119	A9	152	A30	185	V _{SS}
21	D9	54	NC	87	CLKIN	120	A10	153	A31	186	D31
22	D8	55	NC	88	V _{SS}	121	V _{SS}	154	V _{CC}	187	D30
23	D7	56	V _{SS}	89	V _{SS}	122	A11	155	BREQ	188	D29
24	V _{SS}	57	DREQ0	90	NC	123	A12	156	LOCK	189	D28
25	D6	58	DREQ1	91	RESET	124	A13	157	NC	190	V _{CC}
26	D5	59	DREQ2	92	V _{SS}	125	V _{SS}	158	SUP	191	D27
27	D4	60	DREQ3	93	XINT0	126	NC	159	D/C	192	D26
28	V _{CC}	61	V _{CC}	94	XINT1	127	V _{CC}	160	DMA	193	NC
29	NC	62	DACK0	95	XINT2	128	A14	161	V _{SS}	194	D25
30	V _{SS}	63	DACK1	96	V _{CC}	129	A15	162	WAIT	195	D24
31	NC	64	DACK2	97	NC	130	A16	163	DT/R	196	V _{SS}
32	V _{CC}	65	DACK3	98	V _{SS}	131	V _{SS}	164	w/R		
33	D3	66	EOP/TC0	99	V _{CC}	132	A17	165	V _{SS}		

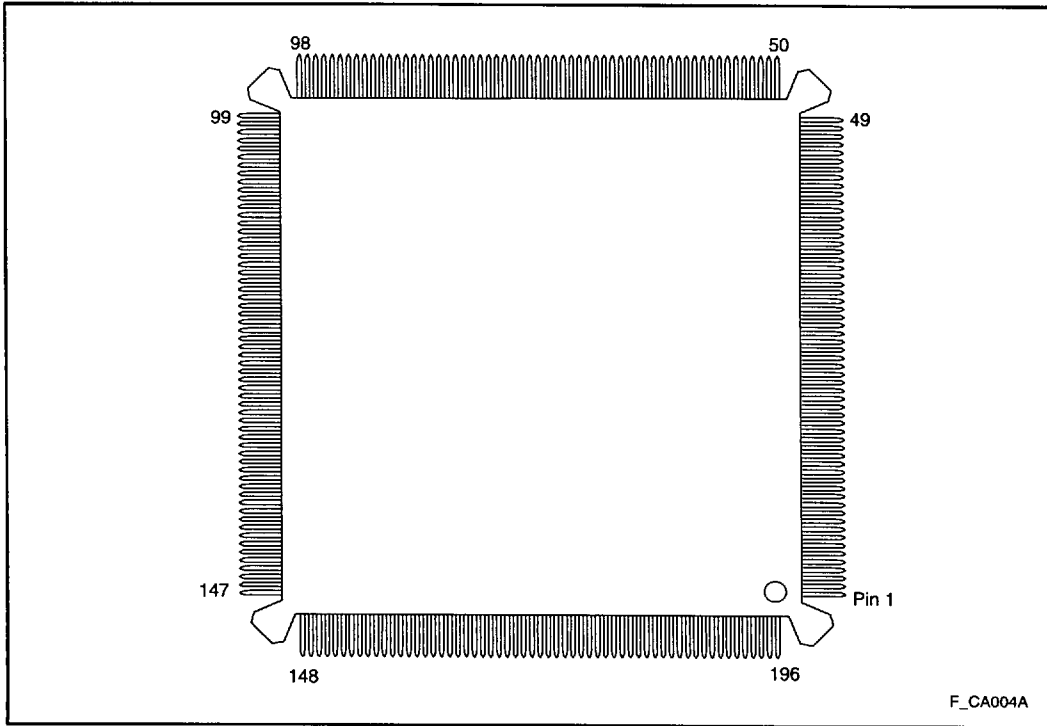

Figure 4. 80960CF PQFP Pinout—Top View (80960CF-33, -25, -16 Only)

3.4 Package Thermal Specifications

The 80960CF is specified for operation when T_C (case temperature) is within the range of 0°C–100°C for 33, 25, and 16 MHz and 0°C–85°C for 40 MHz. T_C may be measured in any environment to determine whether the 80960CF is within specified operating range. Case temperature should be measured at the center of the top surface, opposite the pins. Refer to Figure 5.

T_A (ambient temperature) is calculated from θ_{CA} (thermal resistance from case to ambient) using the equation:

$$T_A = T_C - P \cdot \theta_{CA}$$

Table 9 shows the maximum T_A allowable (without exceeding T_C) at various airflows and operating frequencies (f_{PCLK}).

Note that T_A is greatly improved by attaching fins or a heatsink to the package. P (maximum power consumption) is calculated by using the typical I_{CC} as tabulated in **Section 4.4, DC Specifications** and V_{CC} of 5 V.

PRELIMINARY

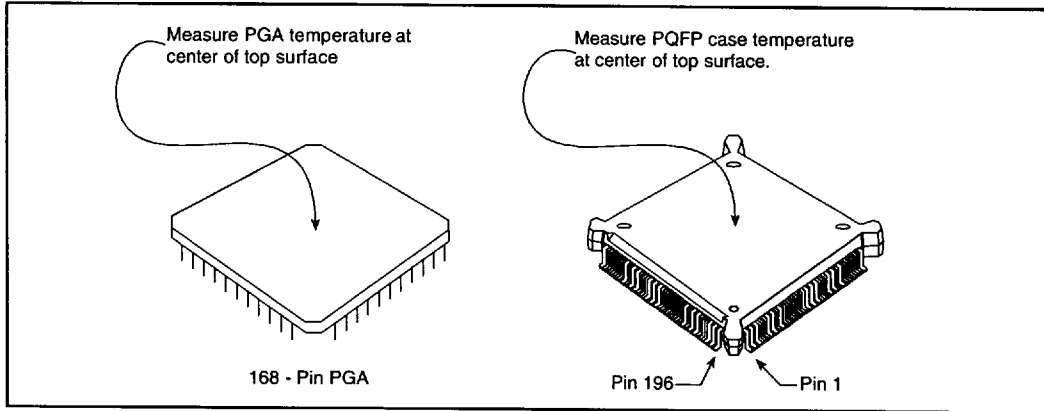

Figure 5. Measuring 80960CF PGA and PQFP Case Temperature

Table 9. Maximum T_A at Various Airflows in $^{\circ}\text{C}$ (PGA Package Only)

	f_{PCLK} (MHz)	Airflow-ft/min (m/sec)					
		0 (0)	200 (1.01)	400 (2.03)	600 (3.04)	800 (4.06)	1000 (5.07)
T_A with Heatsink*	40	20	40	58	60	66	68
	33	38	57	74	76	81	84
	25	50	65	79	81	85	87
	16	63	74	84	86	89	90
T_A without Heatsink*	40	0	15	30	40	50	52
	33	18	33	47	57	66	67
	25	34	46	57	65	72	74
	16	51	60	68	74	80	81

NOTES:

*0.285" high unidirectional heatsink (Al alloy 6061, 50 mil fin width, 150 mil center-to-center fin spacing).

Table 10. 80960CF PGA Package Thermal Characteristics

Thermal Resistance — °C/Watt						
Parameter	Airflow — ft./min (m/sec)					
	0 (0)	200 (1.01)	400 (2.03)	600 (3.07)	800 (4.06)	1000 (5.07)
θ Junction-to-Case (Case measured as shown in Figure 5)	1.5	1.5	1.5	1.5	1.5	1.5
θ Case-to-Ambient (No Heatsink)	17	14	11	9	7.1	6.6
θ Case-to-Ambient (With Heatsink)*	13	9	5.5	5	3.9	3.4

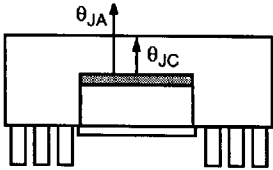
NOTES:

1. This table applies to 80960CF PGA plugged into socket or soldered directly to board.
 2. $\theta_{JA} = \theta_{JC} + \theta_{CA}$
- *0.285" high unidirectional heatsink (Al alloy 6061, 50 mil fin width, 150 mil center-to-center fin spacing).

Table 11. 80960CF PQFP Package Thermal Characteristics

Thermal Resistance — °C/Watt							
Parameter	Airflow — ft./min (m/sec)						
	0 (0)	50 (0.25)	100 (0.50)	200 (1.01)	400 (2.03)	600 (3.04)	800 (4.06)
θ Junction-to-Case (Case Measured as shown in Figure 5)	5	5	5	5	5	5	5
θ Case-to-Ambient (No Heatsink)	19	18	17	15	12	10	9

NOTES:

1. This table applies to 80960CF PQFP soldered directly to board.
2. $\theta_{JA} = \theta_{JC} + \theta_{CA}$

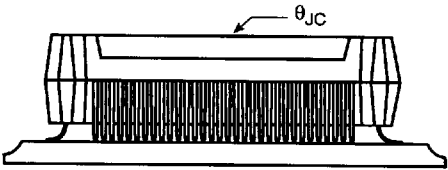



3.5 Stepping Register Information

Upon reset, register g0 contains die stepping information (Figure 6). The most significant byte contains ASCII 0; the upper middle byte contains an ASCII C; the lower middle byte contains an ASCII F. The least significant byte contains the stepping number in

ASCII. g0 retains this information until it is overwritten by the user program. Table 12 contains a cross reference of the number in the least significant byte of register g0 to the die stepping number.

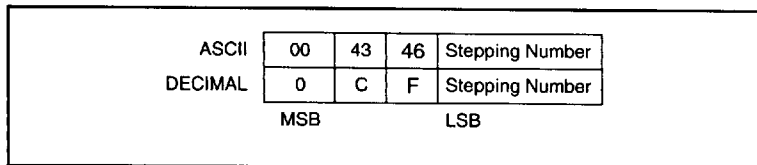

Figure 6. Register g0

Table 12. Die Stepping Cross Reference

g0 Least Significant Byte	Die Stepping
01	A
02	B
03	C
04	D
05	E

3.6 Sources for Accessories

The following is a list of suggested sources for 80960CF accessories. This is neither an endorsement nor a warranty of the performance of any of the listed products and/or companies.

Sockets

- 3M Textool Test and Interconnection Products
6801 River Place Blvd. Mailstop 130-3N-29
Austin, TX 78726-9000
(800) 328-0411
- Augat, Inc. Interconnection Products Group
452 John Dietsch Blvd.
Attleboro Falls, MA 02763
(508) 699-7646
- Concept Mfg., Inc. (Decoupling Sockets)
400 Walnut St. Suite 609
Redwood City, CA 94063
(415) 365-1162 FAX: (415)265-1164

Heatsinks/Fins

- Thermalloy, Inc.
2021 West Valley View Lane
Dallas, TX 75234
(214) 243-4321
FAX: (214) 241-4656
- Wakefield Engineering
60 Audubon Road
Wakefield, MA 01880
(617) 245-5900



4.0 ELECTRICAL SPECIFICATIONS

4.1 Absolute Maximum Ratings

NOTICE: This document contains preliminary information on new products in production. The specifications are subject to change without notice. Verify with your local Intel sales office that you have the latest datasheet before finalizing a design.

Parameter	Maximum Rating
Storage Temperature.....	-65°C to +150°C
Case Temperature Under Bias.....	-65°C to +110°C
Supply Voltage wrt. V _{SS}	-0.5 V to + 6.5 V
Voltage on Other Pins wrt. V _{SS}	-0.5 V to V _{CC} + 0.5 V

***WARNING:** *Stressing the device beyond the "Absolute Maximum Ratings" may cause permanent damage. These are stress ratings only. Operation beyond the "Operating Conditions" is not recommended and extended exposure beyond the "Operating Conditions" may affect device reliability.*

4.2 Operating Conditions

Table 13. Operating Conditions

Symbol	Parameter	Min	Max	Units	Notes
V _{CC}	Supply Voltage			V	
	80960CF-40	4.75	5.25		
	80960CF-33	4.50	5.50		
	80960CF-25 80960CF-16	4.50 4.50	5.50 5.50		
f _{CLK2x}	Input Clock Frequency (2-x Mode)			MHz	
	80960CF-40	0	80		
	80960CF-33	0	66		
	80960CF-25 80960CF-16	0 0	50 32		
f _{CLK1x}	Input Clock Frequency (1-x Mode)			MHz	(1)
	80960CF-40	8	40		
	80960CF-33	8	33		
	80960CF-25 80960CF-16	8 8	25 16		
T _C	Case Temp Under Bias			°C	
	PGA Pkg. (80960CF-40)	0	85		
	PGA Pkg. (80960CF-33, -25, -16 Only)	0	100		
	196-Pin PQFP (80960CF-33, -25, -16 Only)	0	100		

NOTES:

- When in the 1-x input clock mode, CLKIN is an input to an internal phase-locked loop and must maintain a minimum frequency of 8 MHz for proper processor operation. However, in the 1-x mode, CLKIN may still be stopped when the processor is in a reset condition. If CLKIN is stopped, the specified RESET low time must be provided once CLKIN restarts and has stabilized.

PRELIMINARY



4.3 Recommended Connections

Power and ground connections must be made to multiple V_{CC} and V_{SS} (GND) pins. Every 80960CF-based circuit board should include power (V_{CC}) and ground (V_{SS}) planes for power distribution. Every V_{CC} pin must be connected to the power plane, and every V_{SS} pin must be connected to the ground plane. Pins identified as "NC" **must not** be connected in the system.

Liberal decoupling capacitance should be placed near the 80960CF. The processor can cause transient power surges when its numerous output buffers transition, particularly when connected to large capacitive loads.

Low inductance capacitors and interconnects are recommended for best high frequency electrical

performance. Inductance can be reduced by shortening the board traces between the processor and decoupling capacitors as much as possible. Capacitors specifically designed for PGA packages will offer the lowest possible inductance.

For reliable operation, always connect unused inputs to an appropriate signal level. In particular, any unused interrupt (XINT, NMI), DMA (DREQ), or BTERM input should be connected to V_{CC} through a pull-up resistor. Pull-up resistors should be in the range of 20 K Ω for each pin tied high. If READY or HOLD are not used, the unused input should be connected to ground. **N.C. pins must always remain unconnected.** For additional information refer to the *1960[®] Cx Microprocessor User's Manual* (270710).

4.4 DC Specifications

Table 14. DC Characteristics (Sheet 1 of 2)

(80960CF-40, 33, -25, -16 under the conditions described in Section 4.2, Operating Conditions.)

Symbol	Parameter	Min	Max	Units	Notes
V_{IL}	Input Low Voltage for all pins except RESET	-0.3	+0.8	V	
V_{IH}	Input High Voltage for all pins except RESET	2.0	$V_{CC} + 0.3$	V	
V_{OL}	Output Low Voltage		0.45	V	$I_{OL} = 5$ mA
V_{OH}	Output High Voltage $I_{OH} = -1$ mA $I_{OH} = -200$ μ A	2.4 $V_{CC} - 0.5$		V V	
V_{ILR}	Input Low Voltage for RESET	-0.3	1.5	V	
V_{IHR}	Input High Voltage for RESET	3.5	$V_{CC} + 0.3$	V	

NOTES:

1. No pullup or pulldown.
2. These pins have internal pullup resistors.
3. These pins have internal pulldown resistors.
4. Measured at worst case frequency, V_{CC} and temperature, with device operating and outputs loaded to the test conditions described in Section 4.5.1, AC TEST CONDITIONS.
5. I_{CC} Typical is not tested.
6. Output Capacitance is the capacitive load of a floating output.
7. CLKMODE pin has a pulldown resistor only when ONCE pin is deasserted.

Table 14. DC Characteristics (Sheet 2 of 2)
 (80960CF-40, 33, -25, -16 under the conditions described in **Section 4.2, Operating Conditions.**)

Symbol	Parameter	Min	Max	Units	Notes
I_{LI1}	Input Leakage Current for each pin <i>except</i> : BTERM, ONCE, DREQ3:0, STEST, EOP3:0/TC3:0, NMI, XINT7:0, BOFF, READY, HOLD, CLKMODE		±15	µA	$0 \leq V_{IN} \leq V_{CC}$ (1)
I_{LI2}	Input Leakage Current for: BTERM, ONCE, DREQ3:0, STEST, EOP3:0/TC3:0, NMI, XINT7:0, BOFF	0	-300	µA	$V_{IN} = 0.45 \text{ V}$ (2)
I_{LI3}	Input Leakage Current for: READY, HOLD, CLKMODE	0	500	µA	$V_{IN} = 2.4 \text{ V}$ (3,7)
I_{LO}	Output Leakage Current		±15	µA	$0.45 \leq V_{OUT} \leq V_{CC}$
I_{CC}	Supply Current (80960CF-40, 33): $I_{CC \text{ Max}}$ $I_{CC \text{ Typ}}$		1150 1000	mA mA	(4) (5)
I_{CC}	Supply Current (80960CF-25): $I_{CC \text{ Max}}$ $I_{CC \text{ Typ}}$		950 775	mA mA	(4) (5)
I_{CC}	Supply Current (80960CF-16): $I_{CC \text{ Max}}$ $I_{CC \text{ Typ}}$		750 575	mA	(4) (5)
I_{ONCE}	ONCE-mode Supply Current 80960CF-40 80960CF-33, -25, -16		225 150	mA	
C_{IN}	Input Capacitance for: CLKIN, RESET, ONCE, READY, HOLD, DREQ3:0, BOFF, XINT7:0, NMI, BTERM, CLKMODE	0	12	pF	$F_C = 1 \text{ MHz}$
C_{OUT}	Output Capacitance of each output pin		12	pF	$F_C = 1 \text{ MHz}$ (6)
$C_{I/O}$	I/O Pin Capacitance		12	pF	$F_C = 1 \text{ MHz}$

NOTES:

1. No pullup or pulldown.
2. These pins have internal pullup resistors.
3. These pins have internal pulldown resistors.
4. Measured at worst case frequency, V_{CC} and temperature, with device operating and outputs loaded to the test conditions described in **Section 4.5.1, AC TEST CONDITIONS.**
5. $I_{CC \text{ Typical}}$ is not tested.
6. Output Capacitance is the capacitive load of a floating output.
7. CLKMODE pin has a pulldown resistor only when ONCE pin is deasserted.

4.5 AC Specifications

Table 15. 80960CF AC Characteristics (40 MHz) (Sheet 1 of 3)

(80960CF-40 only, per the conditions in 4.2 Operating Conditions and 4.5.1 AC TEST CONDITIONS.)

Symbol	Parameter	Min	Max	Units	Notes	
Input Clock (1,9)						
T_F	CLKIN Frequency	0	80	MHz		
T_C	CLKIN Period	In 1-x Mode (f_{CLK1x})	25	125	ns	(11)
		In 2-x Mode (f_{CLK2x})	12.5	∞	ns	
T_{CS}	CLKIN Period Stability	In 1-x Mode (f_{CLK1x})		$\pm 0.1\%$	Δ (12)	
T_{CH}	CLKIN High Time	In 1-x Mode (f_{CLK1x})	5	62.5	ns	(11)
		In 2-x Mode (f_{CLK2x})	5	∞	ns	
T_{CL}	CLKIN Low Time	In 1-x Mode (f_{CLK1x})	5	62.5	ns	(11)
		In 2-x Mode (f_{CLK2x})	5	∞	ns	
T_{CR}	CLKIN Rise Time	0	6	ns		
T_{CF}	CLKIN Fall Time	0	6	ns		
Output Clocks (1,8)						
T_{CP}	CLKIN to PCLK2:1 Delay	In 1-x Mode (f_{CLK1x})	-2	2	ns	(3,12)
		In 2-x Mode (f_{CLK2x})	2	25	ns	(3)
T	PCLK2:1 Period	In 1-x Mode (f_{CLK1x})	T_C		ns	(12)
		In 2-x Mode (f_{CLK2x})	$2T_C$		ns	(3)
T_{PH}	PCLK2:1 High Time	$(T/2) - 2$	$T/2$	ns	(12)	
T_{PL}	PCLK2:1 Low Time	$(T/2) - 2$	$T/2$	ns	(12)	
T_{PR}	PCLK2:1 Rise Time	1	4	ns	(3)	
T_{PF}	PCLK2:1 Fall Time	1	4	ns	(3)	
Synchronous Outputs (8)						

NOTES:

See Table 18 for all notes related to AC specifications.



Table 15. 80960CF AC Characteristics (40 MHz) (Sheet 2 of 3)
 (80960CF-40 only, per the conditions in **4.2 Operating Conditions** and **4.5.1 AC TEST CONDITIONS**.)

Symbol	Parameter	Min	Max	Units	Notes
T _{OH}	Output Valid Delay, Output Hold				(6,10)
T _{OV}	T _{OH1} , T _{OV1} A31:2	3	14	ns	
	T _{OH2} , T _{OV2} BE3:0	3	16	ns	
	T _{OH3} , T _{OV3} ADS	6	16	ns	
	T _{OH4} , T _{OV4} W/R	3	16	ns	
	T _{OH5} , T _{OV5} D/C, SUP, DMA	4	16	ns	
	T _{OH6} , T _{OV6} BLAST, WAIT	5	16	ns	
	T _{OH7} , T _{OV7} DEN	3	16	ns	
	T _{OH8} , T _{OV8} HOLDA, BREQ	4	16	ns	
	T _{OH9} , T _{OV9} LOCK	4	16	ns	
	T _{OH10} , T _{OV10} DACK3:0	4	16	ns	
	T _{OH11} , T _{OV11} D31:0	3	16	ns	
	T _{OH12} , T _{OV12} DT/R	T/2 + 3	T/2 + 14	ns	
	T _{OH13} , T _{OV13} FAIL	2	14	ns	
	T _{OH14} , T _{OV14} EOP3:0/TC3:0	3	16	ns	(6,10)
T _{OF}	Output Float for all outputs	3	22	ns	(6)
Synchronous Inputs (1,9,10)					
T _{IS}	Input Setup				
	T _{IS1} D31:0	3		ns	
	T _{IS2} BOFF	15		ns	
	T _{IS3} BTERM/READY	7		ns	
	T _{IS4} HOLD	5		ns	
T _{IH}	Input Hold				
	T _{IH1} D31:0	5		ns	
	T _{IH2} BOFF	5		ns	
	T _{IH3} BTERM/READY	2		ns	
	T _{IH4} HOLD	3		ns	

NOTES:
 See Table 18 for all notes related to AC specifications.

Table 15. 80960CF AC Characteristics (40 MHz) (Sheet 3 of 3)
 (80960CF-40 only, per the conditions in 4.2 Operating Conditions and 4.5.1 AC TEST CONDITIONS.)

Symbol	Parameter	Min	Max	Units	Notes
Relative Output Timings (1,2,3,8)					
T _{AVSH1}	A31:2 Valid to ADS Rising	T - 4	T + 4	ns	
T _{AVSH2}	BE3:0, W/R, SUP, D/C, DMA, DACK3:0 Valid to ADS Rising	T - 6	T + 6	ns	
T _{AVEL1}	A31:2 Valid to DEN Falling	T - 4	T + 4	ns	
T _{AVEL2}	BE3:0, W/R, SUP, INST, DMA, DACK3:0 Valid to DEN Falling	T - 6	T + 6	ns	
T _{NLQV}	WAIT Falling to Output Data Valid	± 6		ns	
T _{DVNH}	Output Data Valid to WAIT Rising	N*T - 6	N*T + 6	ns	(4)
T _{NLNH}	WAIT Falling to WAIT Rising	N*T ± 4		ns	(4)
T _{NHQX}	Output Data Hold after WAIT Rising	(N+1)*T-8	(N+1)*T+6	ns	(5)
T _{EHTV}	DT/R Hold after DEN High	T/2 - 7	∞	ns	(6)
T _{TVEL}	DT/R Valid to DEN Falling	T/2 - 4		ns	
Relative Input Timings (1,2,3)					
T _{IS5}	RESET Input Setup (2-x Clock Mode)	6		ns	(13)
T _{IH5}	RESET Input Hold (2-x Clock Mode)	5		ns	(13)
T _{IS6}	DREQ3:0 Input Setup	12		ns	(7)
T _{IH6}	DREQ3:0 Input Hold	7		ns	(7)
T _{IS7}	XINT7:0, NMI Input Setup	7		ns	(15)
T _{IH7}	XINT7:0, NMI Input Hold	3		ns	(15)
T _{IS8}	RESET Input Setup (1-x Clock Mode)	3		ns	(14)
T _{IH8}	RESET Input Hold (1-x Clock Mode)	T/4 + 1		ns	(14)

NOTES:

See Table 18 for all notes related to AC specifications.



Table 16. 80960CF AC Characteristics (33 MHz) (Sheet 1 of 3)
 (80960CF-33 only, per the conditions in 4.2 Operating Conditions and 4.5.1 AC TEST CONDITIONS.)

Symbol	Parameter	Min	Max	Units	Notes	
Input Clock (1,9)						
T _F	CLKIN Frequency	0	66.66	MHz		
T _C	CLKIN Period	In 1-x Mode (f _{CLK1x})	30	125	ns	(11)
		In 2-x Mode (f _{CLK2x})	15	∞	ns	
T _{CS}	CLKIN Period Stability	In 1-x Mode (f _{CLK1x})		±0.1%	Δ	(12)
T _{CH}	CLKIN High Time	In 1-x Mode (f _{CLK1x})	5	62.5	ns	(11)
		In 2-x Mode (f _{CLK2x})	5	∞	ns	
T _{CL}	CLKIN Low Time	In 1-x Mode (f _{CLK1x})	5	62.5	ns	(11)
		In 2-x Mode (f _{CLK2x})	5	∞	ns	
T _{CR}	CLKIN Rise Time	0	6	ns		
T _{CF}	CLKIN Fall Time	0	6	ns		
Output Clocks (1,8)						
T _{CP}	CLKIN to PCLK2:1 Delay	In 1-x Mode (f _{CLK1x})	- 2	2	ns	(3,12)
		In 2-x Mode (f _{CLK2x})	2	25	ns	
T	PCLK2:1 Period	In 1-x Mode (f _{CLK1x})	TC		ns	(12)
		In 2-x Mode (f _{CLK2x})	2TC		ns	
T _{PH}	PCLK2:1 High Time	(T/2) - 2	T/2	ns	(12)	
T _{PL}	PCLK2:1 Low Time	(T/2) - 2	T/2	ns	(12)	
T _{PR}	PCLK2:1 Rise Time	1	4	ns	(3)	
T _{PF}	PCLK2:1 Fall Time	1	4	ns	(3)	

NOTES:

See Table 18 for all notes related to AC specifications.



Table 16. 80960CF AC Characteristics (33 MHz) (Sheet 2 of 3)
(80960CF-33 only, per the conditions in 4.2 Operating Conditions and 4.5.1 AC TEST CONDITIONS.)

Symbol	Parameter	Min	Max	Units	Notes
Synchronous Outputs (8)					
T_{OH} T_{OV}	Output Valid Delay, Output Hold				(6,10)
	T_{OH1}, T_{OV1} A31:2	3	14	ns	
	T_{OH2}, T_{OV2} BE3:0	3	16	ns	
	T_{OH3}, T_{OV3} ADS	6	18	ns	
	T_{OH4}, T_{OV4} W/R	3	18	ns	
	T_{OH5}, T_{OV5} D/C, SUP, DMA	4	16	ns	
	T_{OH6}, T_{OV6} BLAST, WAIT	5	16	ns	
	T_{OH7}, T_{OV7} DEN	3	16	ns	
	T_{OH8}, T_{OV8} HOLDA, BREQ	4	16	ns	
	T_{OH9}, T_{OV9} LOCK	4	16	ns	
	T_{OH10}, T_{OV10} DACK3:0	4	18	ns	
	T_{OH11}, T_{OV11} D31:0	3	16	ns	
	T_{OH12}, T_{OV12} DT/R	$T/2 + 3$	$T/2 + 14$	ns	
	T_{OH13}, T_{OV13} FAIL	2	14	ns	
	T_{OH14}, T_{OV14} EOP3:0/TC3:0	3	18	ns	(6,10)
T_{OF}	Output Float for all outputs	3	22	ns	(6)
Synchronous Inputs (1,9,10)					
T_{IS}	Input Setup				
	TIS1 D31:0	3		ns	
	TIS2 B \overline{O} FF	17		ns	
	TIS3 BTERM/READY	7		ns	
	TIS4 HOLD	7		ns	
T_{IH}	Input Hold				
	TIH1 D31:0	5		ns	
	TIH2 B \overline{O} FF	5		ns	
	TIH3 BTERM/READY	2		ns	
	TIH4 HOLD	3		ns	
Relative Output Timings (1,2,3,8)					
T_{AVSH1}	A31:2 Valid to ADS Rising	$T - 4$	$T + 4$	ns	
T_{AVSH2}	BE3:0, W/R, SUP, D/C, DMA, DACK3:0 Valid to ADS Rising	$T - 6$	$T + 6$	ns	
T_{AVEL1}	A31:2 Valid to DEN Falling	$T - 4$	$T + 4$	ns	
T_{AVEL2}	BE3:0, W/R, SUP, INST, DMA, DACK3:0 Valid to DEN Falling	$T - 6$	$T + 6$	ns	
T_{NLQV}	WAIT Falling to Output Data Valid		± 6	ns	

NOTES:

See Table 18 for all notes related to AC specifications.



Table 16. 80960CF AC Characteristics (33 MHz) (Sheet 3 of 3)
 (80960CF-33 only, per the conditions in 4.2 Operating Conditions and 4.5.1 AC TEST CONDITIONS.)

Symbol	Parameter	Min	Max	Units	Notes
T _{DVNH}	Output Data Valid to $\overline{\text{WAIT}}$ Rising	N*T - 6	N*T + 6	ns	(4)
T _{NLNH}	$\overline{\text{WAIT}}$ Falling to $\overline{\text{WAIT}}$ Rising	N*T ± 4		ns	(4)
T _{NHQX}	Output Data Hold after $\overline{\text{WAIT}}$ Rising	(N+1)*T-8	(N+1)*T+6	ns	(5)
T _{EHTV}	DT/ $\overline{\text{R}}$ Hold after $\overline{\text{DEN}}$ High	T/2 - 7	∞	ns	(6)
T _{TVEL}	DT/ $\overline{\text{R}}$ Valid to $\overline{\text{DEN}}$ Falling	T/2 - 4		ns	
Relative Input Timings (1,2,3)					
T _{IS5}	RESET Input Setup (2-x Clock Mode)	6		ns	(13)
T _{IH5}	RESET Input Hold (2-x Clock Mode)	5		ns	(13)
T _{IS6}	DREQ3:0 Input Setup	12		ns	(7)
T _{IH6}	DREQ3:0 Input Hold	7		ns	(7)
T _{IS7}	XINT7:0, NMI Input Setup	7		ns	(15)
T _{IH7}	XINT7:0, NMI Input Hold	3		ns	(15)
T _{IS8}	RESET Input Setup (1-x Clock Mode)	3		ns	(14)
T _{IH8}	RESET Input Hold (1-x Clock Mode)	T/4 + 1		ns	(14)

NOTES:

See Table 18 for all notes related to AC specifications.

PRELIMINARY

Table 17. 80960CF AC Characteristics (25 MHz) (Sheet 1 of 2)
(80960CF-25 only, per the conditions in 4.2 Operating Conditions and 4.5.1 AC TEST CONDITIONS.)

Symbol	Parameter	Min	Max	Unit	Notes	
Input Clock (1,9)						
T_F	CLKIN Frequency	0	50	MHz		
T_C	CLKIN Period	In 1-x Mode (f CLK1x)	40	125	ns	(11)
		In 2-x Mode (f CLK2x)	20	∞	ns	
T_{CS}	CLKIN Period Stability		$\pm 0.1\%$	Δ	(12)	
T_{CH}	CLKIN High Time	In 1-x Mode (f CLK1x)	8	62.5	ns	(11)
		In 2-x Mode (f CLK2x)	8	∞	ns	
T_{CL}	CLKIN Low Time	In 1-x Mode (f CLK1x)	8	62.5	ns	(11)
		In 2-x Mode (f CLK2x)	8	∞	ns	
T_{CR}	CLKIN Rise Time	0	6	ns		
T_{CF}	CLKIN Fall Time	0	6	ns		
Output Clocks (1,8)						
T_{CP}	CLKIN to PCLK2:1 Delay	In 1-x Mode (f CLK1x)	-2	2	ns	(3,12)
		In 2-x Mode (f CLK2x)	2	25	ns	(3)
T	PCLK2:1 Period	In 1-x Mode (f CLK1x)	T_C		ns	(12)
		In 2-x Mode (f CLK2x)	$2T_C$		ns	(3)
T_{PH}	PCLK2:1 High Time	$(T/2) - 3$	$T/2$	ns	(12)	
T_{PL}	PCLK2:1 Low Time	$(T/2) - 3$	$T/2$	ns	(12)	
T_{PR}	PCLK2:1 Rise Time	1	4	ns	(3)	
T_{PF}	PCLK2:1 Fall Time	1	4	ns	(3)	
Synchronous Outputs (8)						
T_{OH}	Output Valid Delay, Output Hold				(6,10)	
T_{OV}	T_{OH1}, T_{OV1}	A31:2	3	16	ns	(6,10)
	T_{OH2}, T_{OV2}	BE3:0	3	18	ns	
	T_{OH3}, T_{OV3}	ADS	6	20	ns	
	T_{OH4}, T_{OV4}	W/R	3	20	ns	
	T_{OH5}, T_{OV5}	D/C, SUP, DMA	4	18	ns	
	T_{OH6}, T_{OV6}	BLAST, WAIT	5	18	ns	
	T_{OH7}, T_{OV7}	DEN	3	18	ns	
	T_{OH8}, T_{OV8}	HOLDA, BREQ	4	18	ns	
	T_{OH9}, T_{OV9}	LOCK	4	18	ns	
	T_{OH10}, T_{OV10}	DACK3:0	4	20	ns	
	T_{OH11}, T_{OV11}	D31:0	3	18	ns	
	T_{OH12}, T_{OV12}	DT/R	$T/2 + 3$	$T/2 + 16$	ns	
	T_{OH13}, T_{OV13}	FAIL	2	16	ns	
	T_{OH14}, T_{OV14}	EOP3:0/TC3:0	3	20	ns	
T_{OF}	Output Float for all outputs	3	22	ns	(6)	

NOTES: See Table 18 for all notes related to AC specifications.



Table 17. 80960CF AC Characteristics (25 MHz) (Sheet 2 of 2)
 (80960CF-25 only, per the conditions in 4.2 Operating Conditions and 4.5.1 AC TEST CONDITIONS.)

Symbol	Parameter	Min	Max	Unit	Notes
Synchronous Inputs (1,9,10)					
T _{IS}	Input Setup				
	T _{IS1} D31:0	5		ns	
	T _{IS2} B _{OFF}	19		ns	
	T _{IS3} BTERM/READY	9		ns	
T _{IS4} HOLD	9		ns		
T _{IH}	Input Hold				
	T _{IH1} D31:0	5		ns	
	T _{IH2} B _{OFF}	7		ns	
	T _{IH3} BTERM/READY	2		ns	
T _{IH4} HOLD	5		ns		
Relative Output Timings (1,2,3,8)					
T _{AVSH1}	A31:2 Valid to \overline{ADS} Rising	T - 4	T + 4	ns	
T _{AVSH2}	BE3:0, W/R, SUP, D/C, DMA, DACK3:0 Valid to \overline{ADS} Rising	T - 6	T + 6	ns	
T _{AVEL1}	A31:2 Valid to \overline{DEN} Falling	T - 4	T + 4	ns	
T _{AVEL2}	BE3:0, W/R, SUP, INST, DMA, DACK3:0 Valid to \overline{DEN} Falling	T - 6	T + 6	ns	
T _{NLQV}	WAIT Falling to Output Data Valid	± 6		ns	
T _{DVNH}	Output Data Valid to WAIT Rising	N*T - F	N*T + 6	ns	(4)
T _{NLNH}	WAIT Falling to WAIT Rising	N*T ± 4		ns	(4)
T _{NHQX}	Output Data Hold after WAIT Rising	(N+1)*T - 8	(N+1)*T + 6	ns	(5)
T _{EHTV}	DT/R Hold after \overline{DEN} High	T/2 - 7	∞	ns	(6)
T _{TVEL}	DT/R Valid to \overline{DEN} Falling	T/2 - 4		ns	
Relative Input Timings (1,2,3)					
T _{IS5}	RESET Input Setup (2-x Clock Mode)	8		ns	(13)
T _{IH5}	RESET Input Hold (2-x Clock Mode)	7		ns	(13)
T _{IS6}	DREQ3:0 Input Setup	14		ns	(7)
T _{IH6}	DREQ3:0 Input Hold	9		ns	(7)
T _{IS7}	XINT7:0, NMI Input Setup	9		ns	(15)
T _{IH7}	XINT7:0, NMI Input Hold	5		ns	(15)
T _{IS8}	RESET Input Setup (1-x Clock Mode)	3		ns	(14)
T _{IH8}	RESET Input Hold (1-x Clock Mode)	T/4 + 1		ns	(14)

NOTES: See Table 18 for all notes related to AC specifications.

Table 18. 80960CF AC Characteristics (16 MHz) (Sheet 1 of 3)
 (80960CF-16 only, per the conditions in 4.2 Operating Conditions and 4.5.1 AC TEST CONDITIONS.)

Symbol	Parameter	Min	Max	Units	Notes	
Input Clock (1,9)						
T_F	CLKIN Frequency	0	32	MHz		
T_C	CLKIN Period	In 1-x Mode (f_{CLK1x}) In 2-x Mode (f_{CLK2x})	62.5 31.25	125 ∞	ns ns	(11)
T_{CS}	CLKIN Period Stability	In 1-x Mode (f_{CLK1x})		$\pm 0.1\%$	Δ	(12)
T_{CH}	CLKIN High Time	In 1-x Mode (f_{CLK1x}) In 2-x Mode (f_{CLK2x})	10 10	62.5 ∞	ns ns	(11)
T_{CL}	CLKIN Low Time	In 1-x Mode (f_{CLK1x}) In 2-x Mode (f_{CLK2x})	10 10	62.5 ∞	ns ns	(11)
T_{CR}	CLKIN Rise Time		0	6	ns	
T_{CF}	CLKIN Fall Time		0	6	ns	
Output Clocks (1,8)						
T_{CP}	CLKIN to PCLK2:1 Delay	In 1-x Mode (f_{CLK1x}) In 2-x Mode (f_{CLK2x})	-2 2	2 25	ns ns	(3,12) (3)
T	PCLK2:1 Period	In 1-x Mode (f_{CLK1x}) In 2-x Mode (f_{CLK2x})	TC 2TC		ns ns	(12) (3)
T_{PH}	PCLK2:1 High Time		$(T/2) - 4$	$T/2$	ns	(12)
T_{PL}	PCLK2:1 Low Time		$(T/2) - 4$	$T/2$	ns	(12)
T_{PR}	PCLK2:1 Rise Time		1	4	ns	(3)
T_{PF}	PCLK2:1 Fall Time		1	4	ns	(3)
Synchronous Outputs (8)						
T_{OH} T_{OV}	Output Valid Delay, Output Hold					(6,10)
	T_{OH1}, T_{OV1} A31:2	3	18	ns		
	T_{OH2}, T_{OV2} BE3:0	3	20	ns		
	T_{OH3}, T_{OV3} ADS	6	22	ns		
	T_{OH4}, T_{OV4} W/R	3	22	ns		
	T_{OH5}, T_{OV5} D/C, SUP, DMA	4	20	ns		
	T_{OH6}, T_{OV6} BLAST, WAIT	5	20	ns		
	T_{OH7}, T_{OV7} DEN	3	20	ns		
	T_{OH8}, T_{OV8} HOLDA, BREQ	4	20	ns		
	T_{OH9}, T_{OV9} LOCK	4	22	ns		
	T_{OH10}, T_{OV10} DACK3:0	3	20	ns		
	T_{OH11}, T_{OV11} D31:0	$T/2 + 3$	$T/2 + 18$	ns		
	T_{OH12}, T_{OV12} DT/R	2	18	ns		
	T_{OH13}, T_{OV13} FAIL	3	22	ns		(6,10)
	T_{OH14}, T_{OV14} EOP3:0/TC3:0					
T_{OF}	Output Float for all outputs	3	22	ns		(6)



Table 18. 80960CF AC Characteristics (16 MHz) (Sheet 2 of 3)
 (80960CF-16 only, per the conditions in 4.2 Operating Conditions and 4.5.1 AC TEST CONDITIONS.)

Symbol	Parameter	Min	Max	Units	Notes
Synchronous Inputs (1,9,10)					
T _{IS}	Input Setup				
	T _{IS1} D31:0	5		ns	
	T _{IS2} BOFF	21		ns	
	T _{IS3} BTERM/READY	9		ns	
	T _{IS4} HOLD	9		ns	
T _{IH}	Input Hold				
	T _{IH1} D31:0	5		ns	
	T _{IH2} BOFF	7		ns	
	T _{IH3} BTERM/READY	2		ns	
	T _{IH4} HOLD	5		ns	
Relative Output Timings (1,2,3,8)					
T _{AVSH1}	A31:2 Valid to ADS Rising	T - 4	T + 4	ns	
T _{AVSH2}	BE3:0, W/R, SUP, D/C, DMA, DACK3:0 Valid to ADS Rising	T - 6	T + 6	ns	
T _{AVEL1}	A31:2 Valid to DEN Falling	T - 6	T + 6	ns	
T _{AVEL2}	BE3:0, W/R, SUP, INST, DMA, DACK3:0 Valid to DEN Falling	T - 6	T + 6	ns	
T _{NLQV}	WAIT Falling to Output Data Valid	± 6		ns	
T _{DVNH}	Output Data Valid to WAIT Rising	N*T - 6	N*T + 6	ns	(4)
T _{NLNH}	WAIT Falling to WAIT Rising	N*T ± 4		ns	(4)
T _{NHQX}	Output Data Hold after WAIT Rising	(N+1)*T-8	(N+1)*T+6	ns	(5)
T _{EHTV}	DT/R Hold after DEN High	T/2 - 7	∞	ns	(6)
T _{TVEL}	DT/R Valid to DEN Falling	T/2 - 4		ns	
Relative Input Timings (1,2,3)					
T _{IS5}	RESET Input Setup (2-x Clock Mode)	10		ns	(13)
T _{IH5}	RESET Input Hold (2-x Clock Mode)	9		ns	(13)
T _{IS6}	DREQ3:0 Input Setup	16		ns	(7)
T _{IH6}	DREQ3:0 Input Hold	11		ns	(7)
T _{IS7}	XINT7:0, NMI Input Setup	9		ns	(15)

PRELIMINARY

Table 18. 80960CF AC Characteristics (16 MHz) (Sheet 3 of 3)
(80960CF-16 only, per the conditions in 4.2 Operating Conditions and 4.5.1 AC TEST CONDITIONS.)

Symbol	Parameter	Min	Max	Units	Notes
T_{IH7}	XINT7:0, NMI Input Hold	5		ns	(15)
T_{IS8}	RESET Input Setup (1-x Clock Mode)	3		ns	(14)
T_{IH8}	RESET Input Hold (1-x Clock Mode)	$T/4 + 1$		ns	(14)

NOTES:

- See Section 4.5.2, AC TIMING WAVEFORMS for waveforms and definitions.
- See Figure 16 for capacitive derating information for output delays and hold times.
- See Figure 17 for capacitive derating information for rise and fall times.
- Where N is the number of NRAD, NRDD, NWAD or NWDD wait states that are programmed in the Bus Controller Region Table. WAIT never goes active when there are no wait states in an access.
- N = Number of wait states inserted with READY.
- Output Data and/or DT/R may be driven indefinitely following a cycle if there is no subsequent bus activity.
- Since asynchronous inputs are synchronized internally by the 80960CF, they have no required setup or hold times to be recognized and for proper operation. However, to guarantee recognition of the input at a particular edge of PCLK2:1, the setup times shown must be met. Asynchronous inputs must be active for at least two consecutive PCLK2:1 rising edges to be seen by the processor.
- These specifications are guaranteed by the processor.
- These specifications must be met by the system for proper operation of the processor.
- This timing is dependent upon the loading of PCLK2:1. Use the derating curves of Section 4.5.3, DERATING CURVES to adjust the timing for PCLK2:1 loading.
- In the 1-x input clock mode, the maximum input clock period is limited to 125 ns while the processor is operating. When the processor is in reset, the input clock may stop even in 1-x mode.
- When in the 1-x input clock mode, these specifications assume a stable input clock with a period variation of less than $\pm 0.1\%$ between adjacent cycles.
- In 2-x clock mode, RESET is an asynchronous input which has no required setup and hold time for proper operation. However, to guarantee the device exits reset synchronized to a particular clock edge, the RESET pin must meet setup and hold times to the falling edge of the CLKIN. (See Figure 23.)
- In 1-x clock mode, RESET is an asynchronous input which has no required setup and hold time for proper operation. However, to guarantee the device exits reset synchronized to a particular clock edge, the RESET pin must meet setup and hold times to the rising edge of the CLKIN. (See Figure 24.)
- The interrupt pins are synchronized internally by the 80960CF. They have no required setup or hold times for proper operation. These pins are sampled by the interrupt controller every other clock and must be active for at least three consecutive PCLK2:1 rising edges when asserting them asynchronously. To guarantee recognition at a particular clock edge, the setup and hold times shown must be met for two consecutive PCLK2:1 rising edges.

4.5.1 AC TEST CONDITIONS

The AC Specifications in Section 4.5 are tested with the 50 pF load shown in Figure 7. Figure 16 shows how timings vary with load capacitance.

Specifications are measured at the 1.5V crossing point, unless otherwise indicated. Input waveforms are assumed to have a rise and fall time of ≤ 2 ns from 0.8V to 2.0V. See Section 4.5.2, AC TIMING WAVEFORMS for AC specification definitions, test points and illustrations.

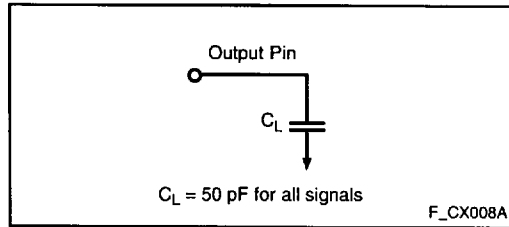

Figure 7. AC Test Load

4.5.2 AC TIMING WAVEFORMS

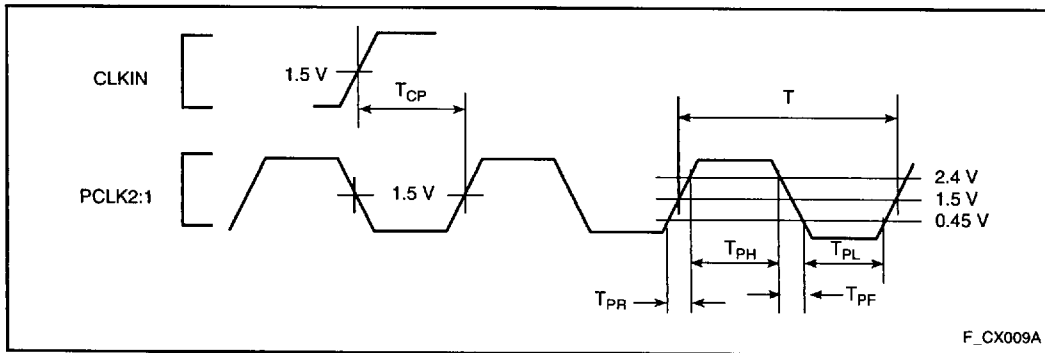

Figure 8. Input and Output Clocks Waveform

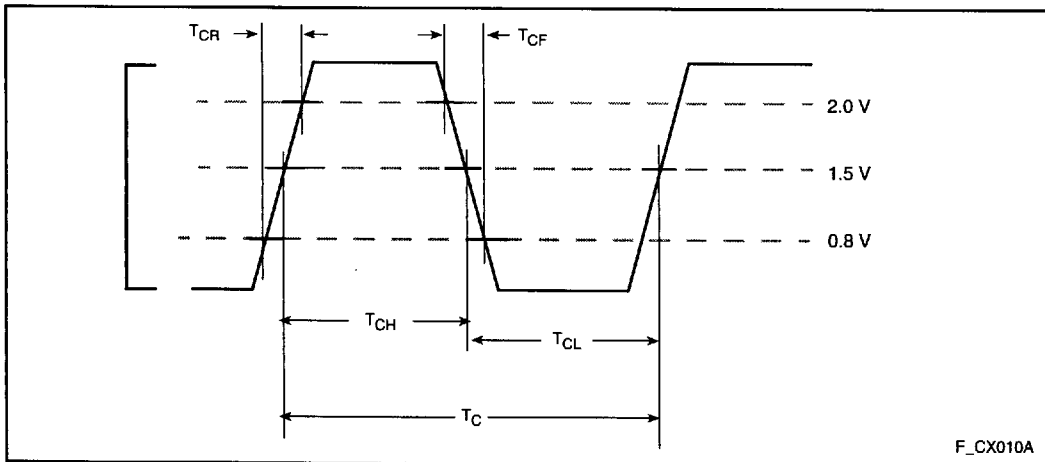

Figure 9. CLKIN Waveform

PRELIMINARY

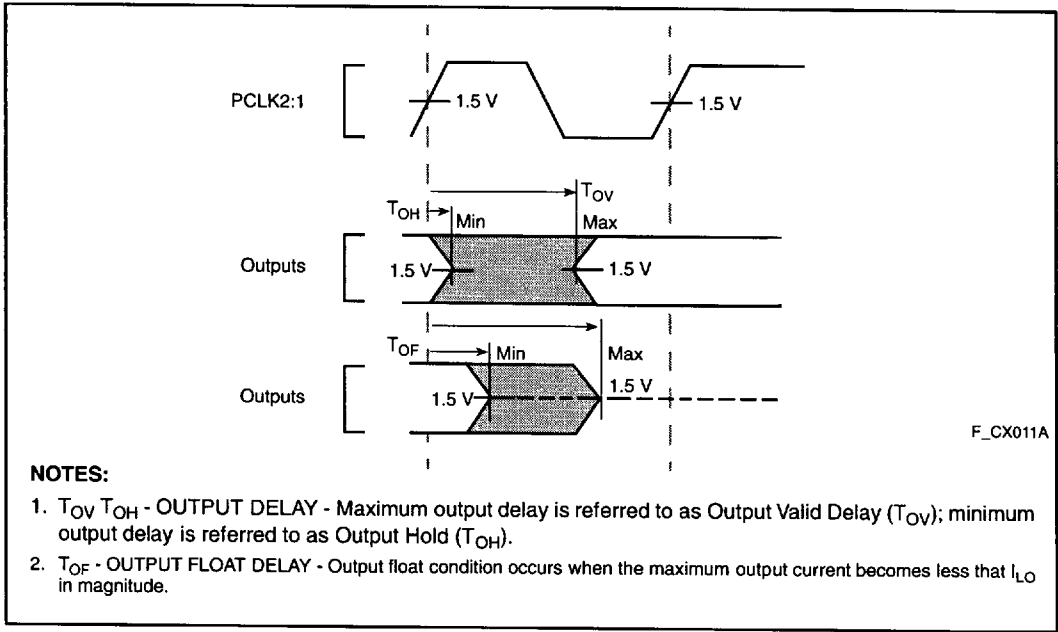

Figure 10. Output Delay and Float Waveform

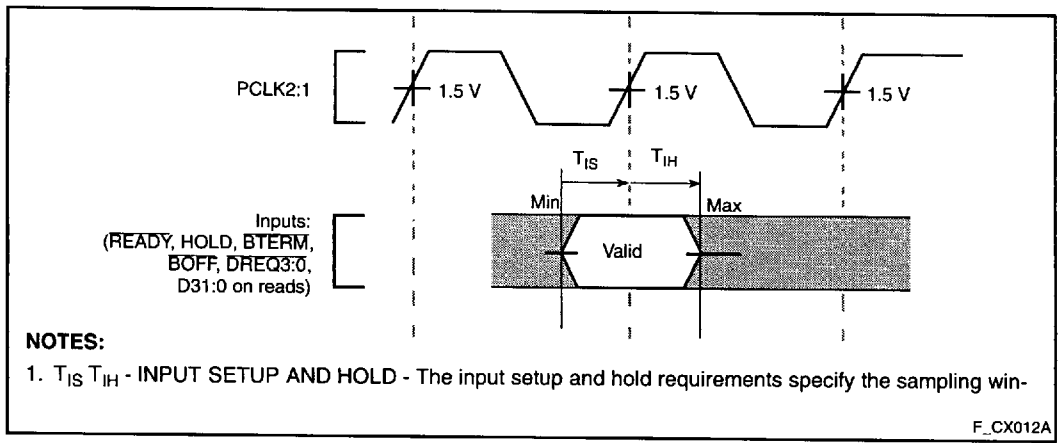

Figure 11. Input Setup and Hold Waveform

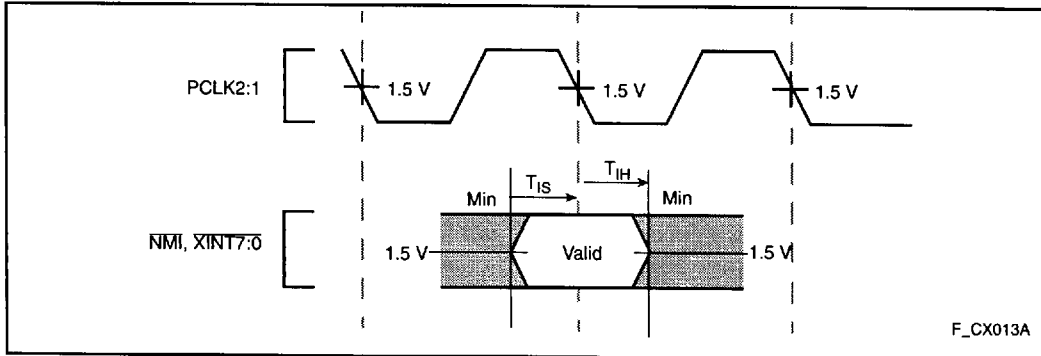

Figure 12. NMI, XINT7:0 Input Setup and Hold Waveform

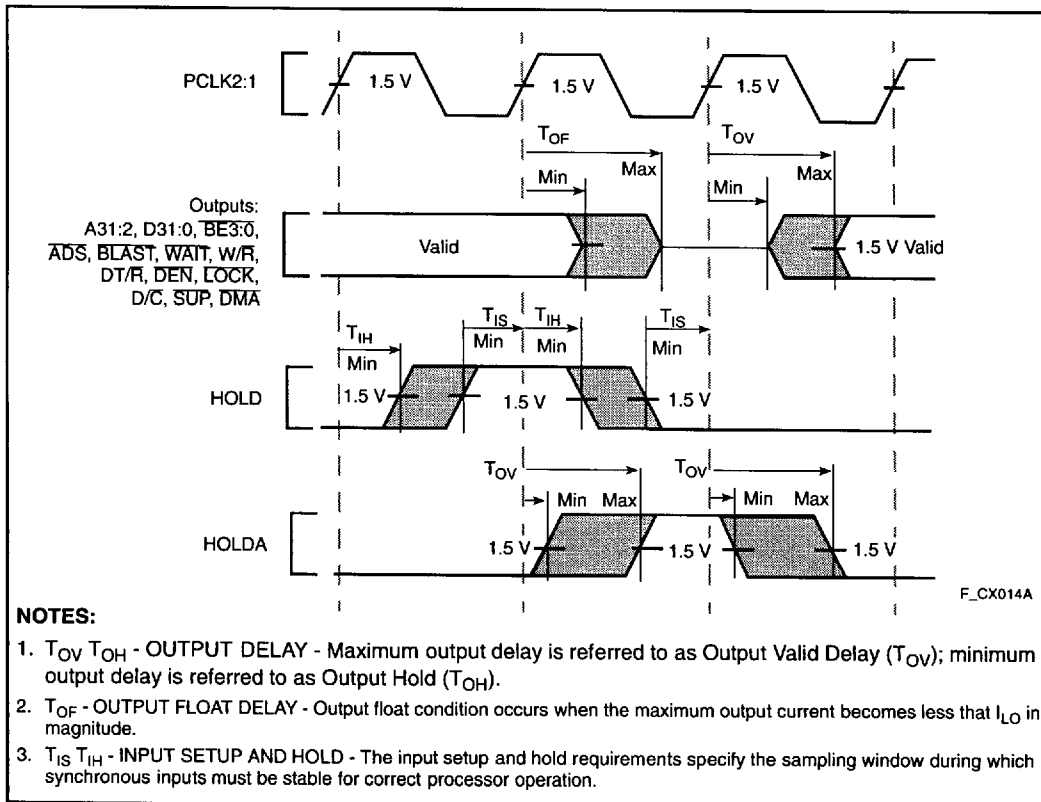

Figure 13. Hold Acknowledge Timings

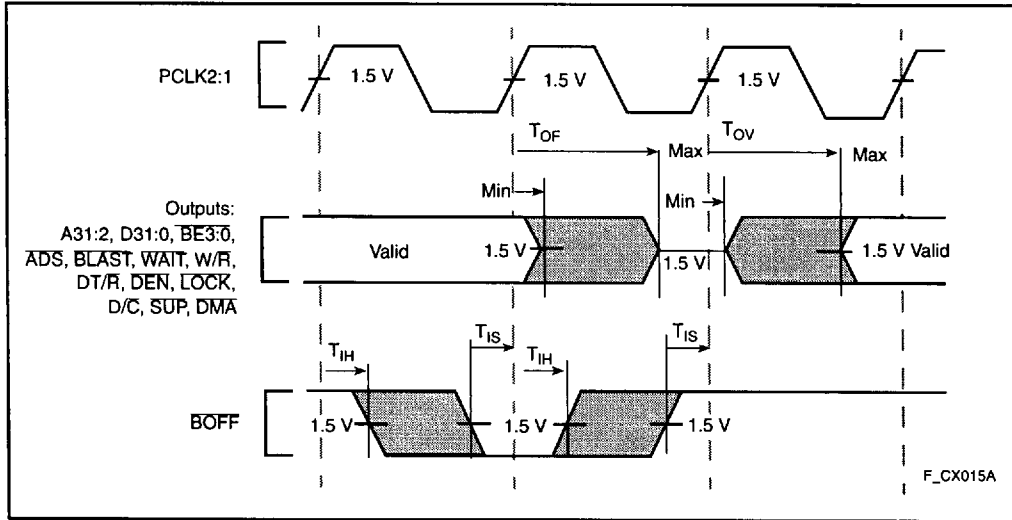

Figure 14. Bus Backoff (BOFF) Timings

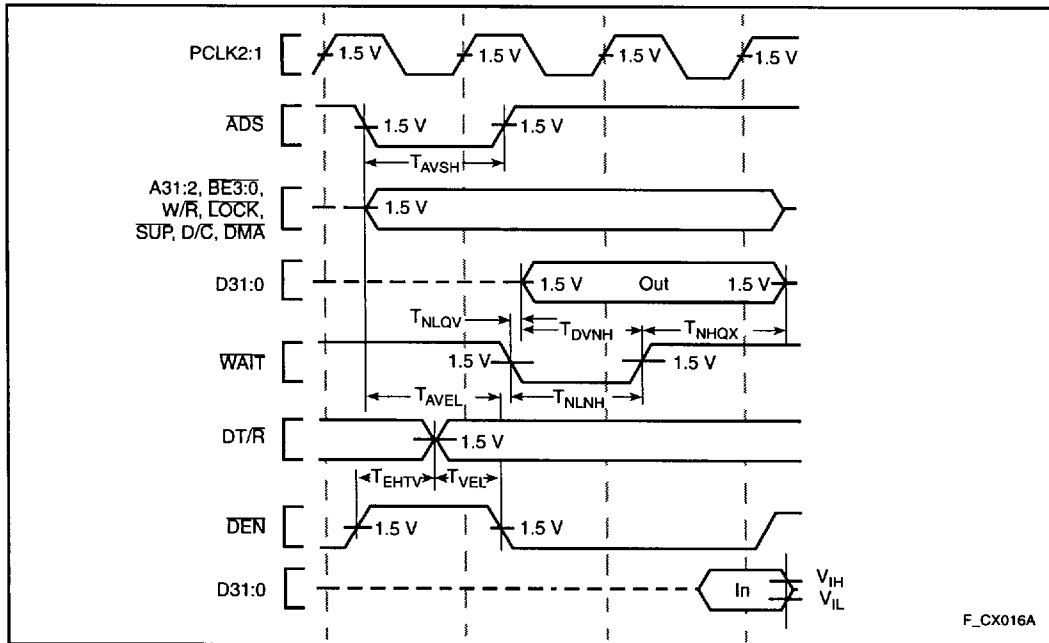

Figure 15. Relative Timings Waveforms

4.5.3 DERATING CURVES

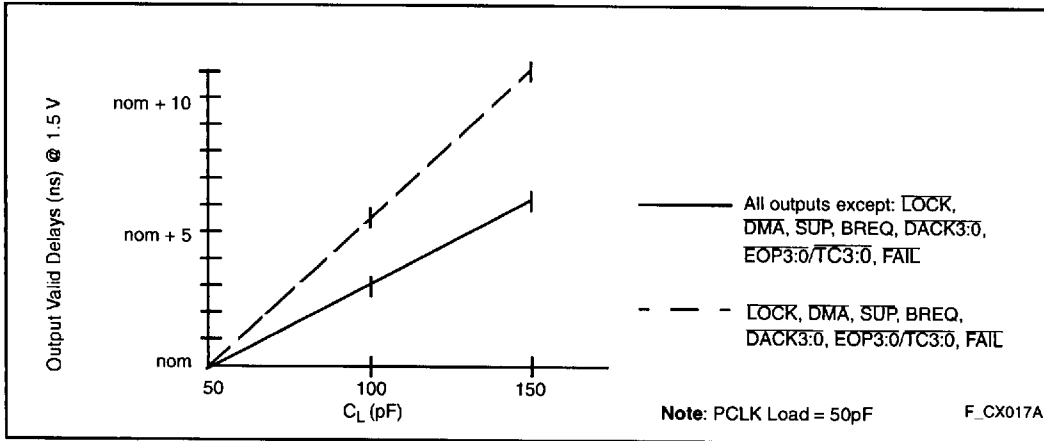

Figure 16. Output Delay or Hold vs. Load Capacitance

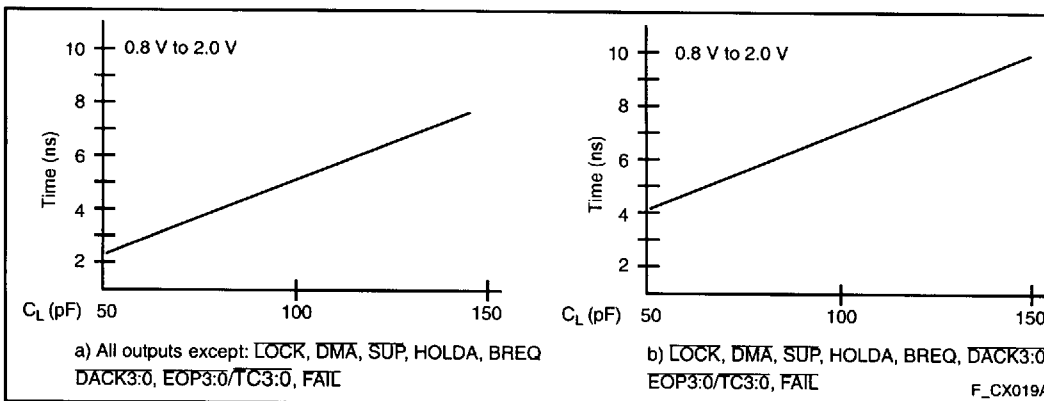

Figure 17. Rise and Fall Time Derating at Highest Operating Temperature and Minimum V_{CC}

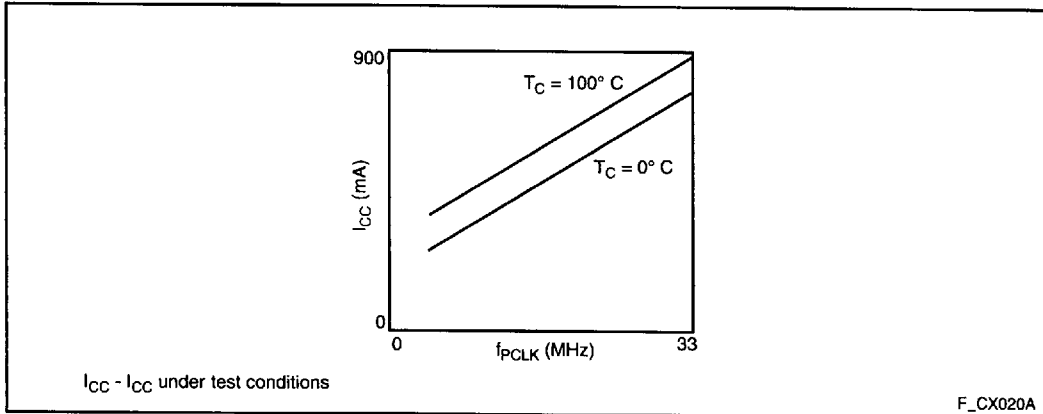

Figure 18. I_{CC} vs. Frequency and Temperature—80960CF-33, -25, -16

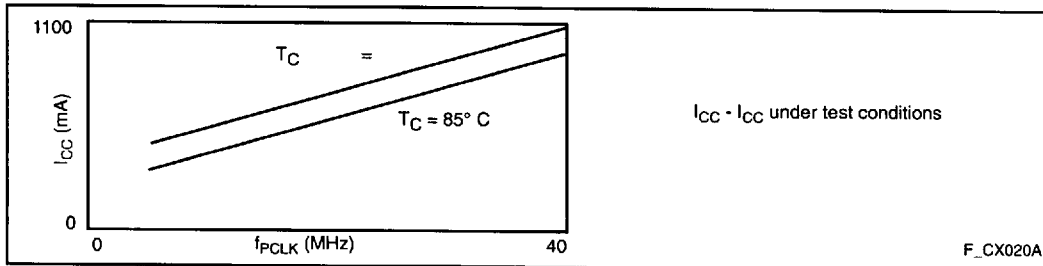

Figure 19. I_{CC} vs. Frequency and Temperature—80960CF-40

5.0 RESET, BACKOFF AND HOLD ACKNOWLEDGE

Table 19 lists the condition of each processor output pin while $\overline{\text{RESET}}$ is asserted (low). Table 20 lists the condition of each processor output pin while HOLDA is asserted (high).

In Table 20, with regard to bus output pin state only, the Hold Acknowledge state takes precedence over the reset state. Although asserting the $\overline{\text{RESET}}$ pin internally resets the processor, the processor's bus output pins do not enter the reset state if Hold Acknowledge has been granted to a previous HOLD request (HOLDA is active). Furthermore, the processor grants new HOLD requests and enters the Hold Acknowledge state even while in reset.

For example, if HOLD is asserted while HOLDA is inactive and the processor is in the reset state, the processor's bus pins enter the Hold Acknowledge state and HOLDA is granted. The processor is not able to perform memory accesses until the HOLD request is removed, even if the $\overline{\text{RESET}}$ pin is brought high. This operation is provided to simplify boot-up synchronization among multiple processors sharing the same bus.



Table 19. Reset Conditions

Pins	State During Reset (HOLDA inactive)
A31:2	Floating
D31:0	Floating
BE3:0	Driven high (Inactive)
W/R	Driven low (Read)
ADS	Driven high (Inactive)
WAIT	Driven high (Inactive)
BLAST	Driven low (Active)
DT/R	Driven low (Receive)
DEN	Driven high (Inactive)
LOCK	Driven high (Inactive)
BREQ	Driven low (Inactive)
D/C	Floating
DMA	Floating
SUP	Floating
FAIL	Driven low (Active)
DACK3:0	Driven high (Inactive)
EOP3:0/TC3:0	Floating (Set to input mode)

Table 20. Hold Acknowledge and Backoff Conditions

Pins	State During HOLDA
A31:2	Floating
D31:0	Floating
BE3:0	Floating
W/R	Floating
ADS	Floating
WAIT	Floating
BLAST	Floating
DT/R	Floating
DEN	Floating
LOCK	Floating
BREQ	Driven (High or low)
D/C	Floating
DMA	Floating
SUP	Floating
FAIL	Driven high (Inactive)
DACK3:0	Driven high (Inactive)
EOP3:0/TC3:0	Driven (If output)

PRELIMINARY

6.0 BUS WAVEFORMS

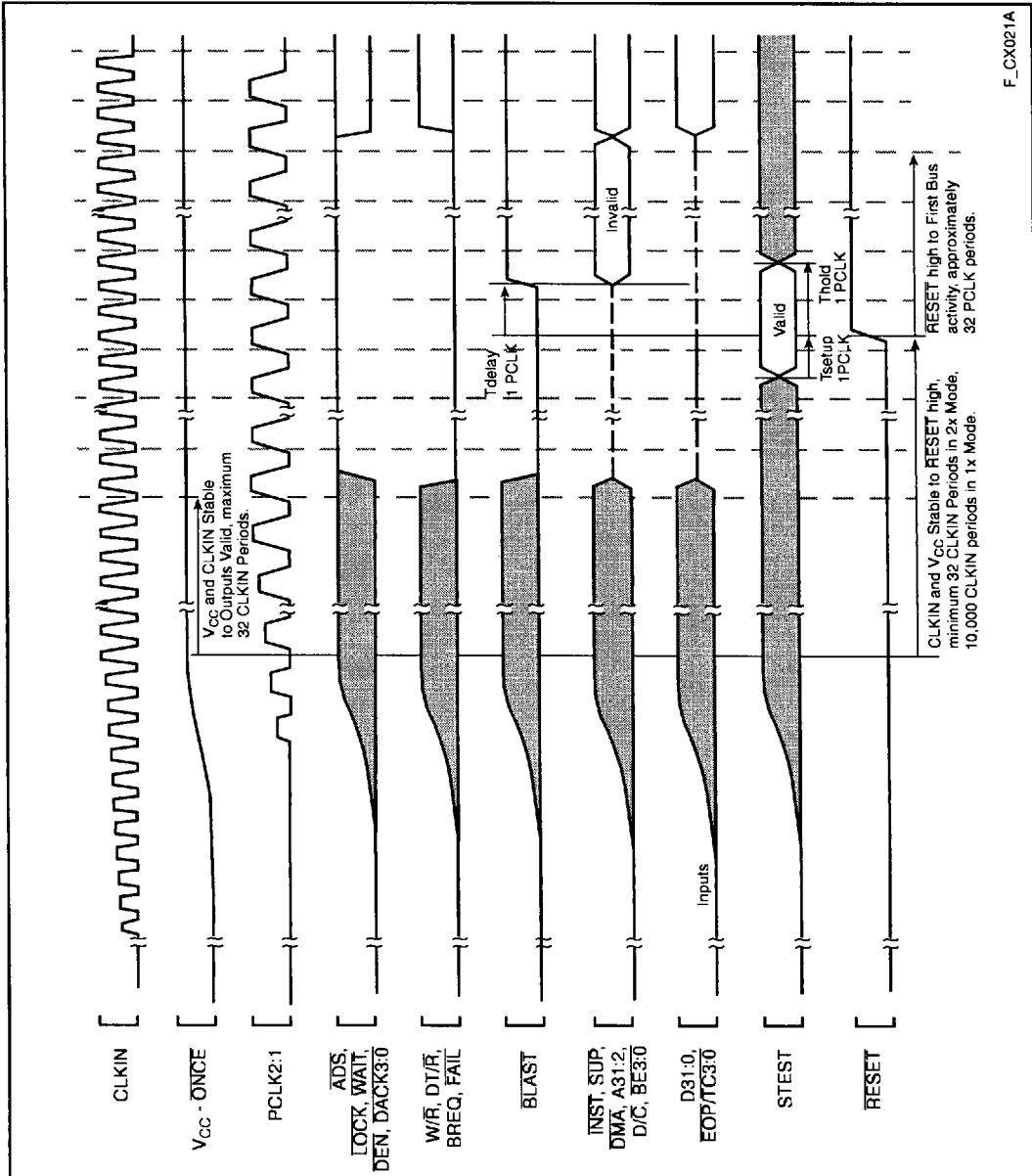

F_CX021A

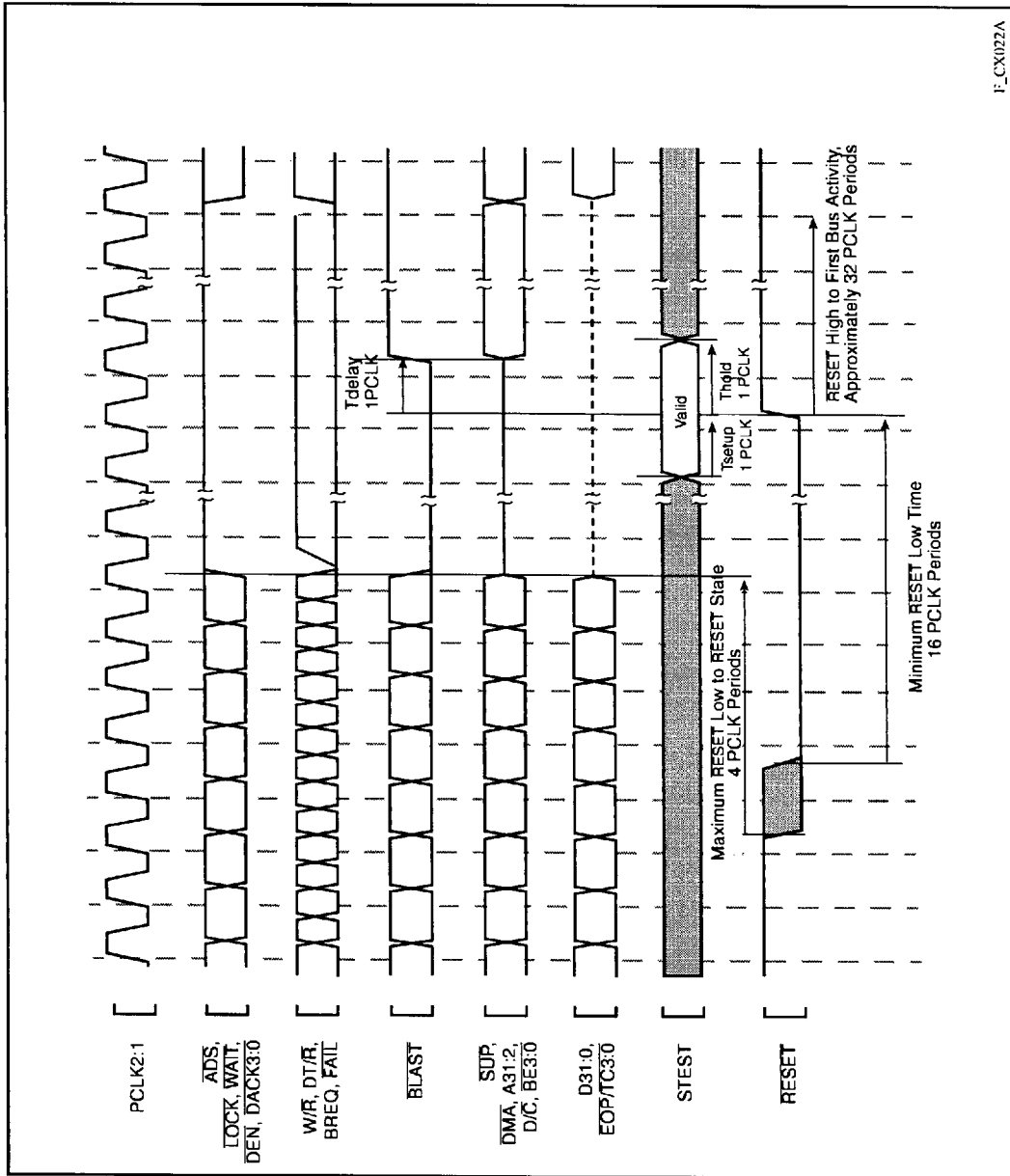

F_CX1022A

Figure 21. Warm Reset Waveform

PRELIMINARY

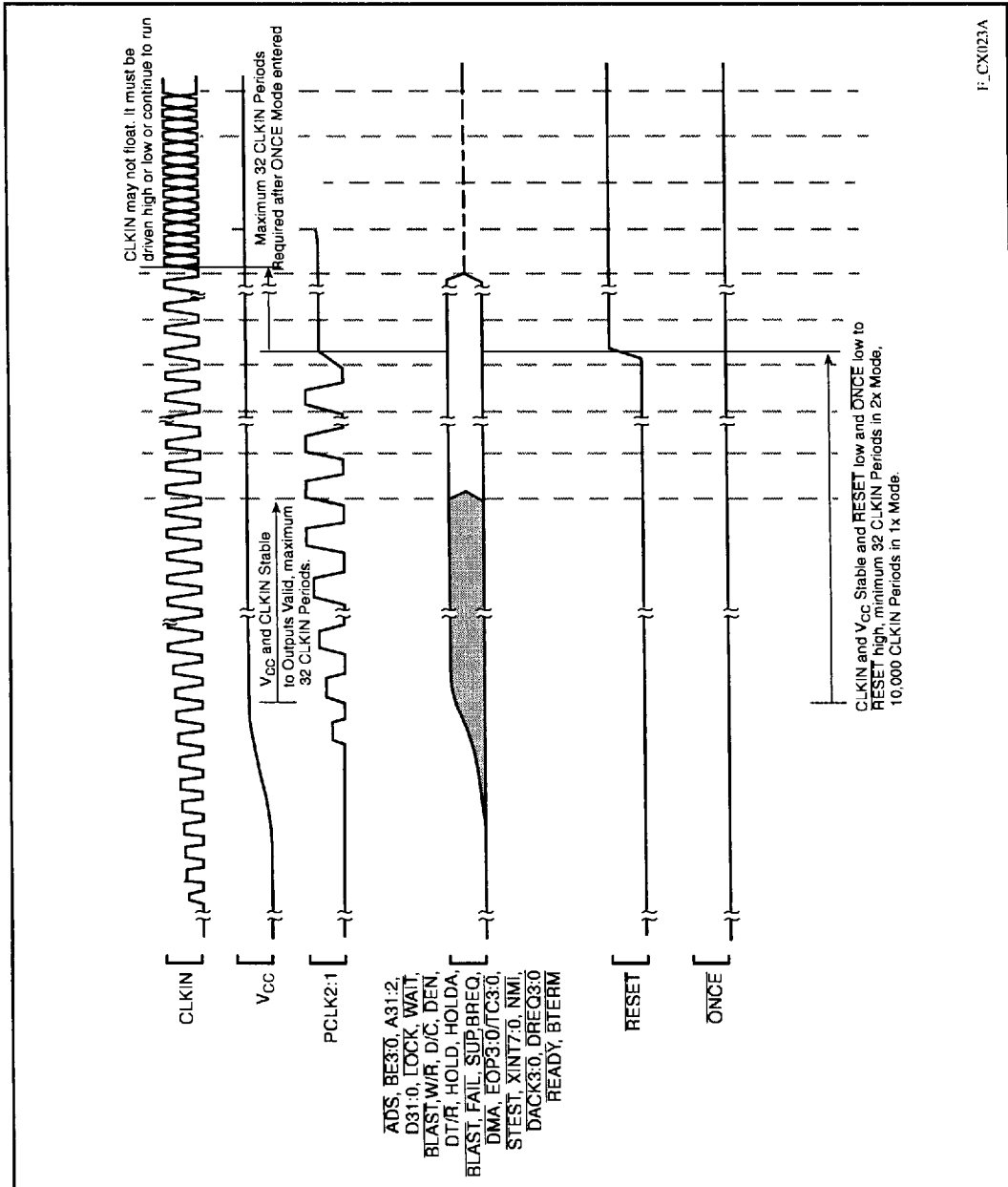

F_CX/023A

Figure 22. Entering the ONCE State

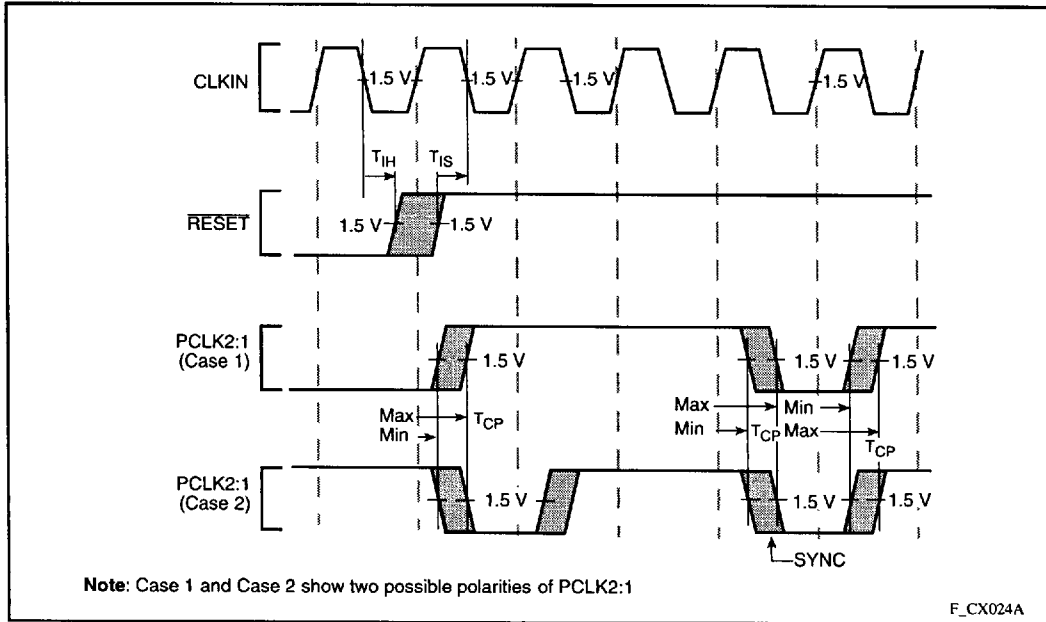

Figure 23. Clock Synchronization in the 2-x Clock Mode

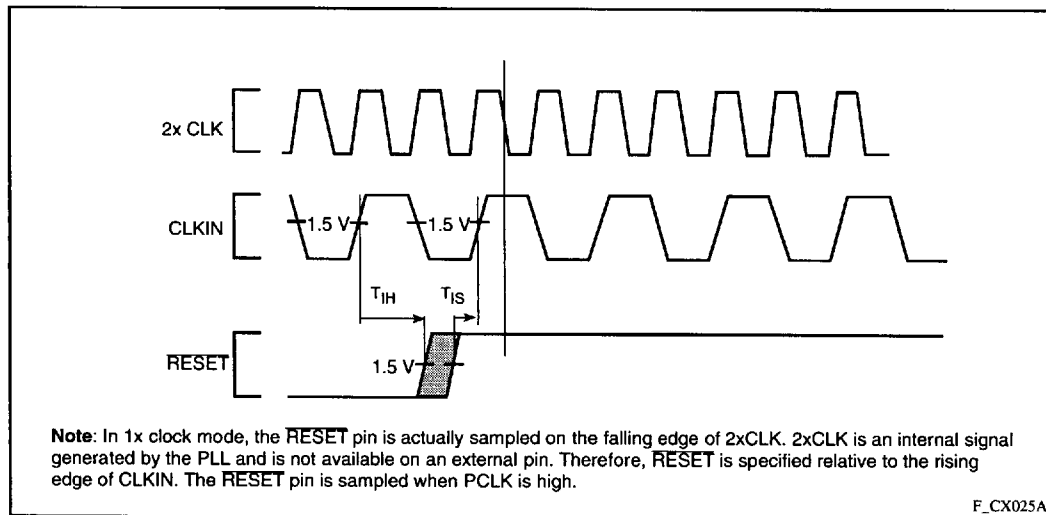

Figure 24. Clock Synchronization in the 1-x Clock Mode

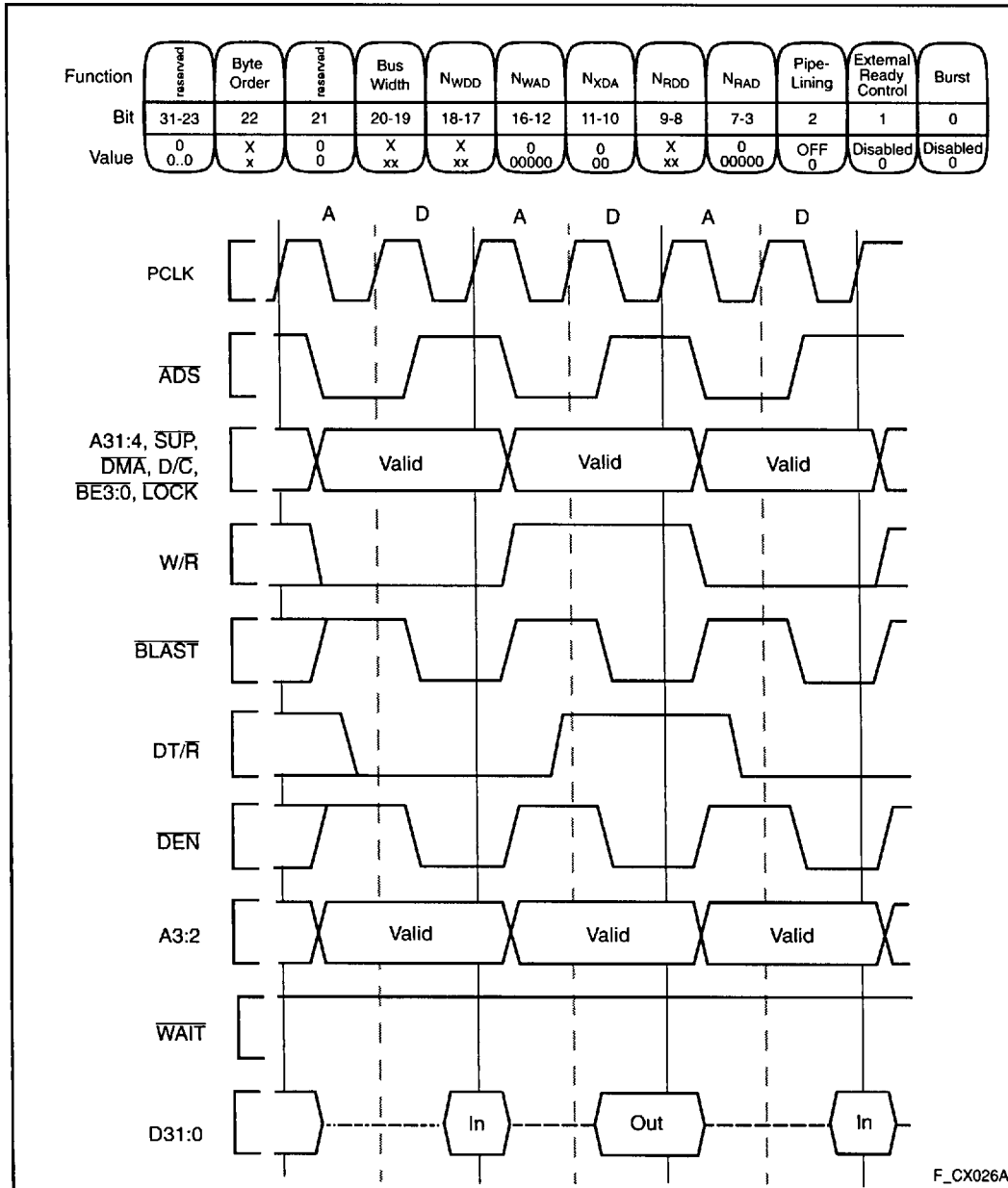

Figure 25. Non-Burst, Non-Pipelined Requests Without Wait States

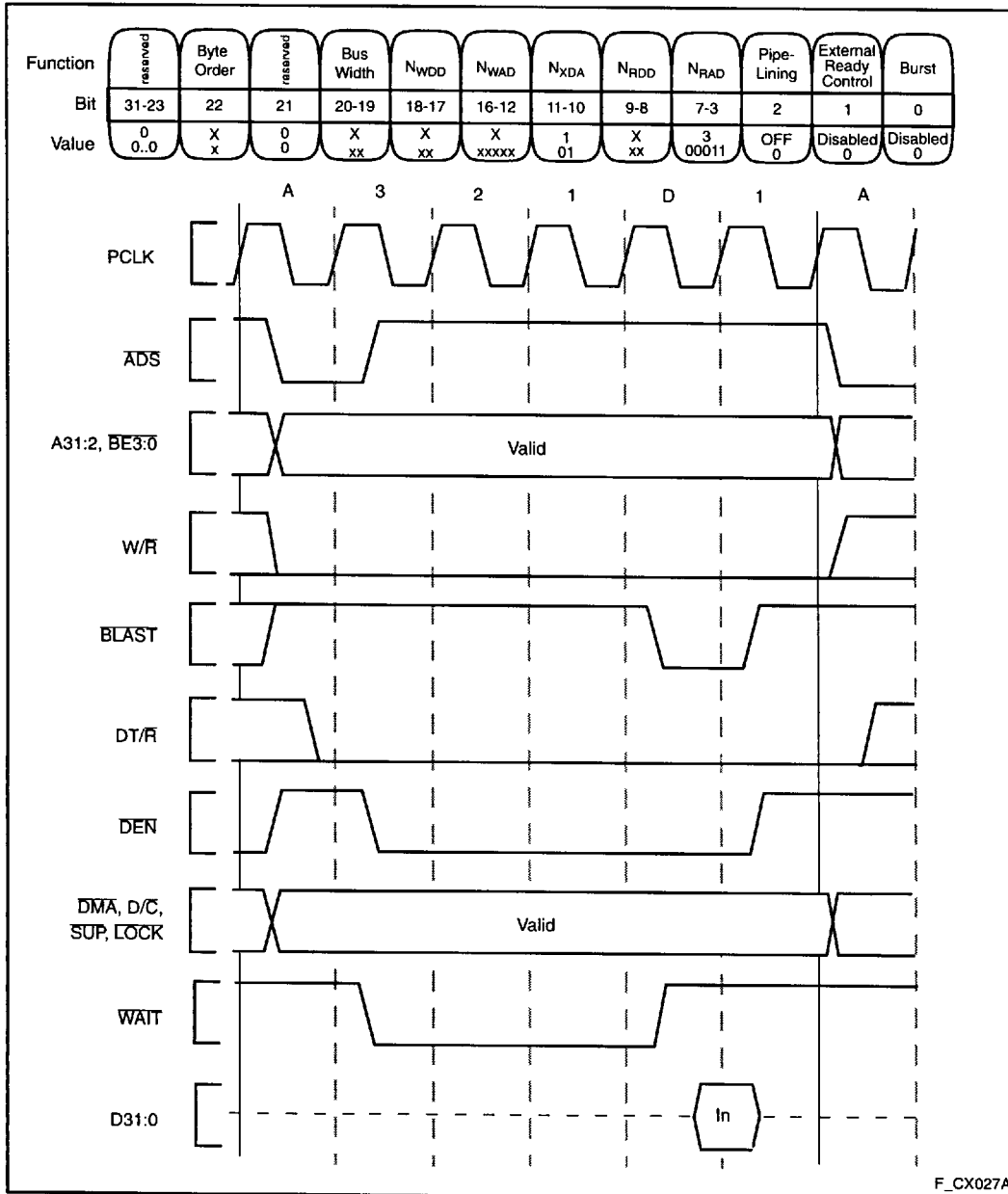

Figure 26. Non-Burst, Non-Pipelined Read Request With Wait States

PRELIMINARY

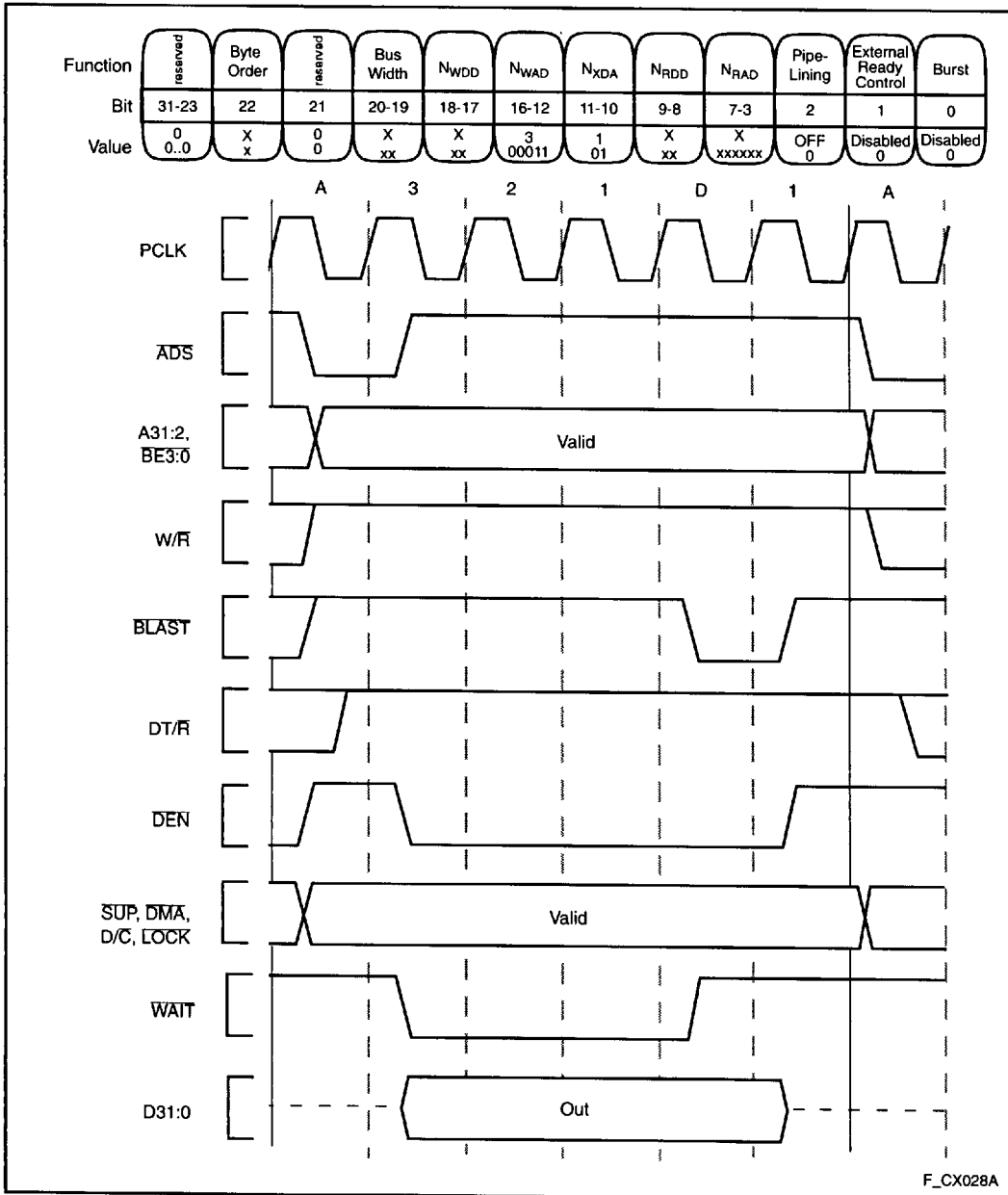

Figure 27. Non-Burst, Non-Pipelined Write Request With Wait States

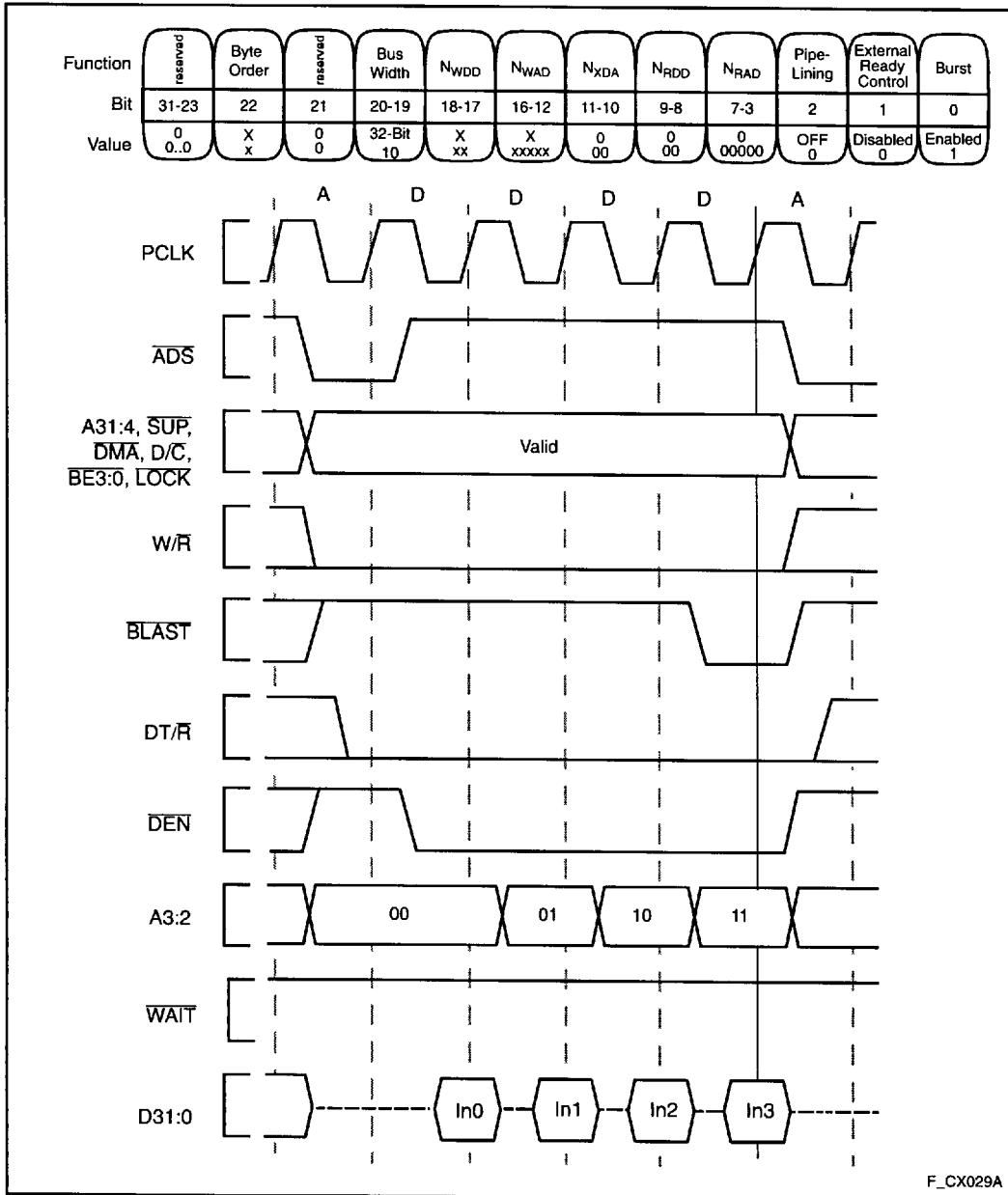

Figure 28. Burst, Non-Pipelined Read Request Without Wait States, 32-Bit Bus

PRELIMINARY

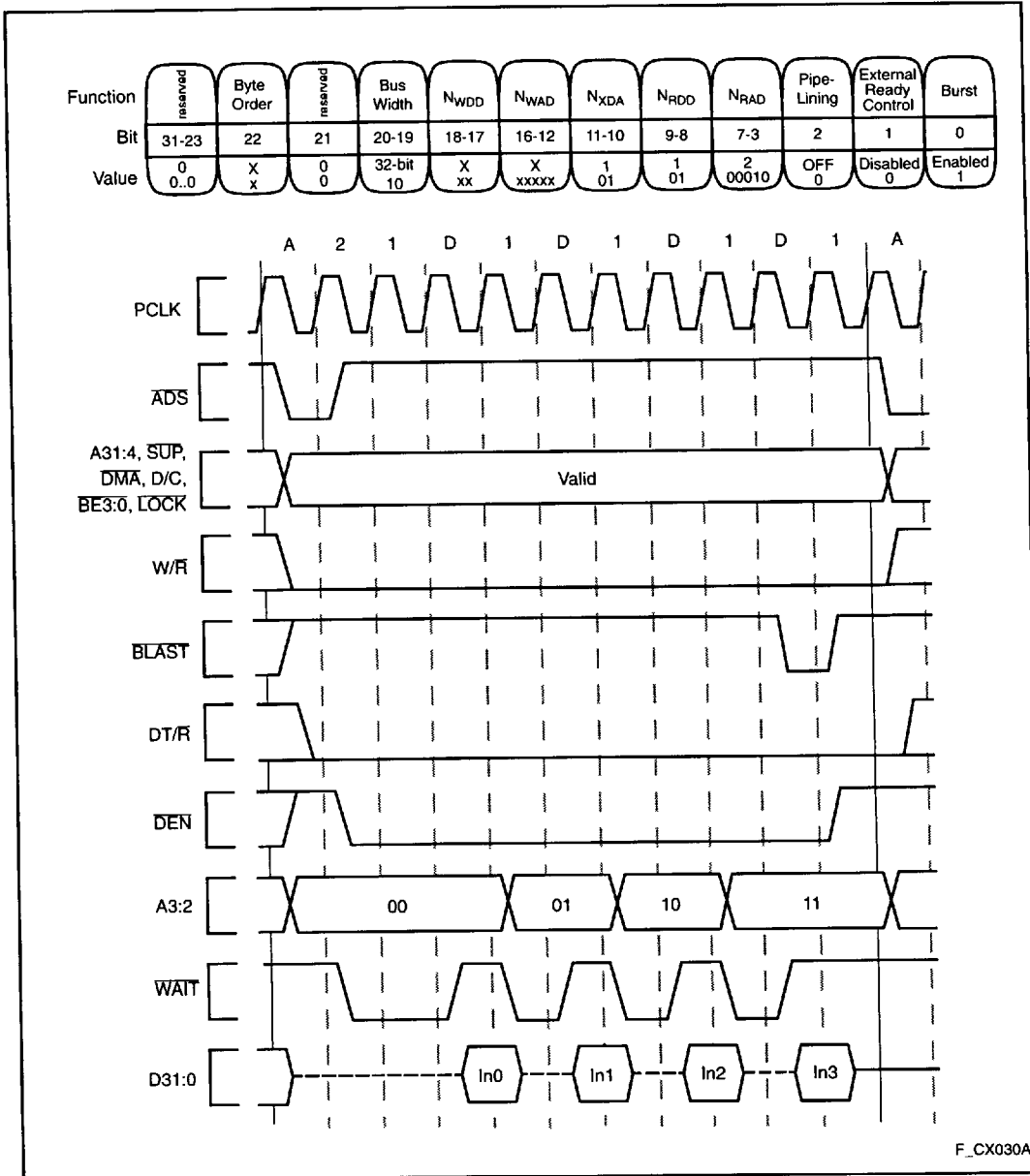

Figure 29. Burst, Non-Pipelined Read Request With Wait States, 32-Bit Bus

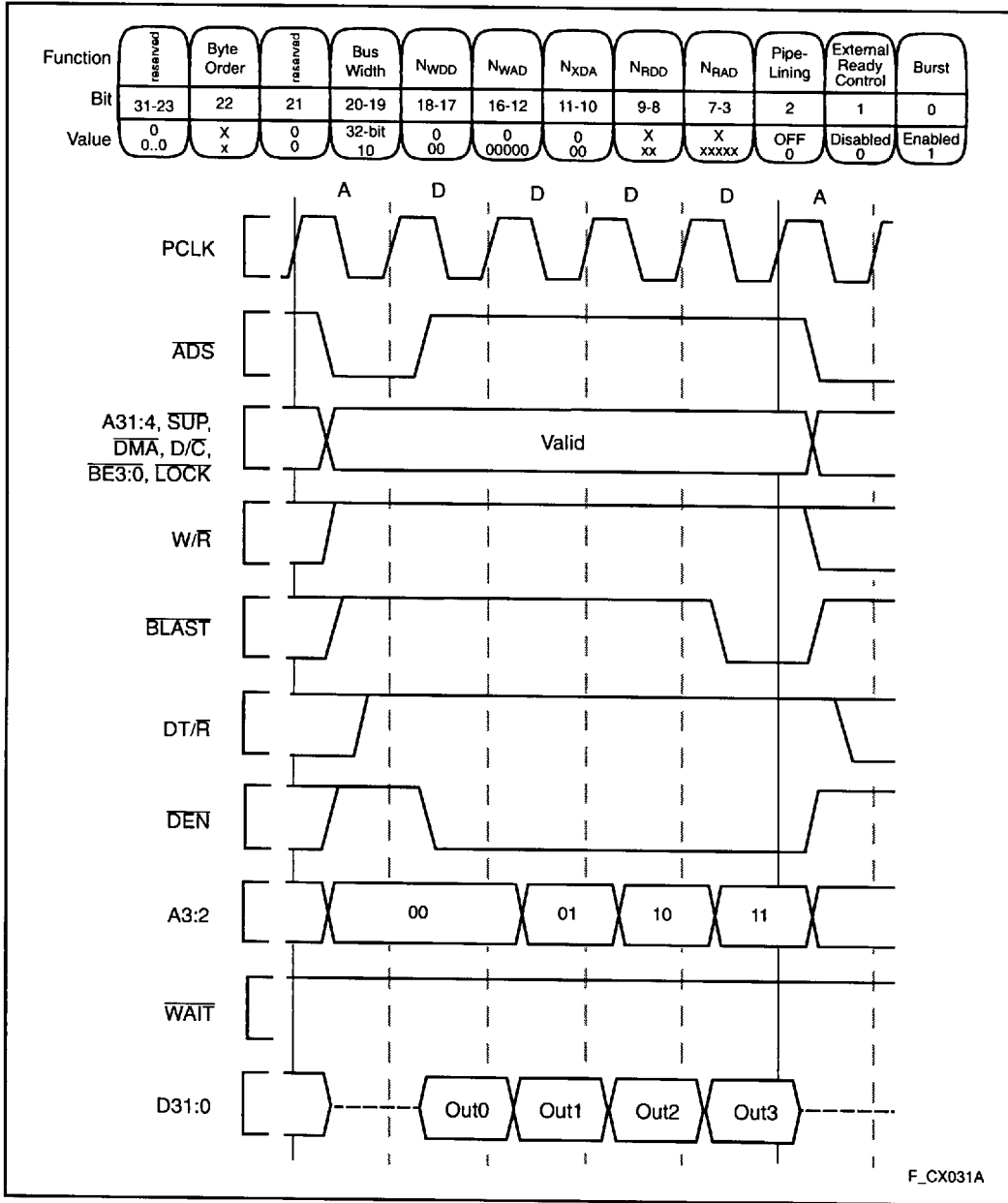

Figure 30. Burst, Non-Pipelined Write Request Without Wait States, 32-Bit Bus

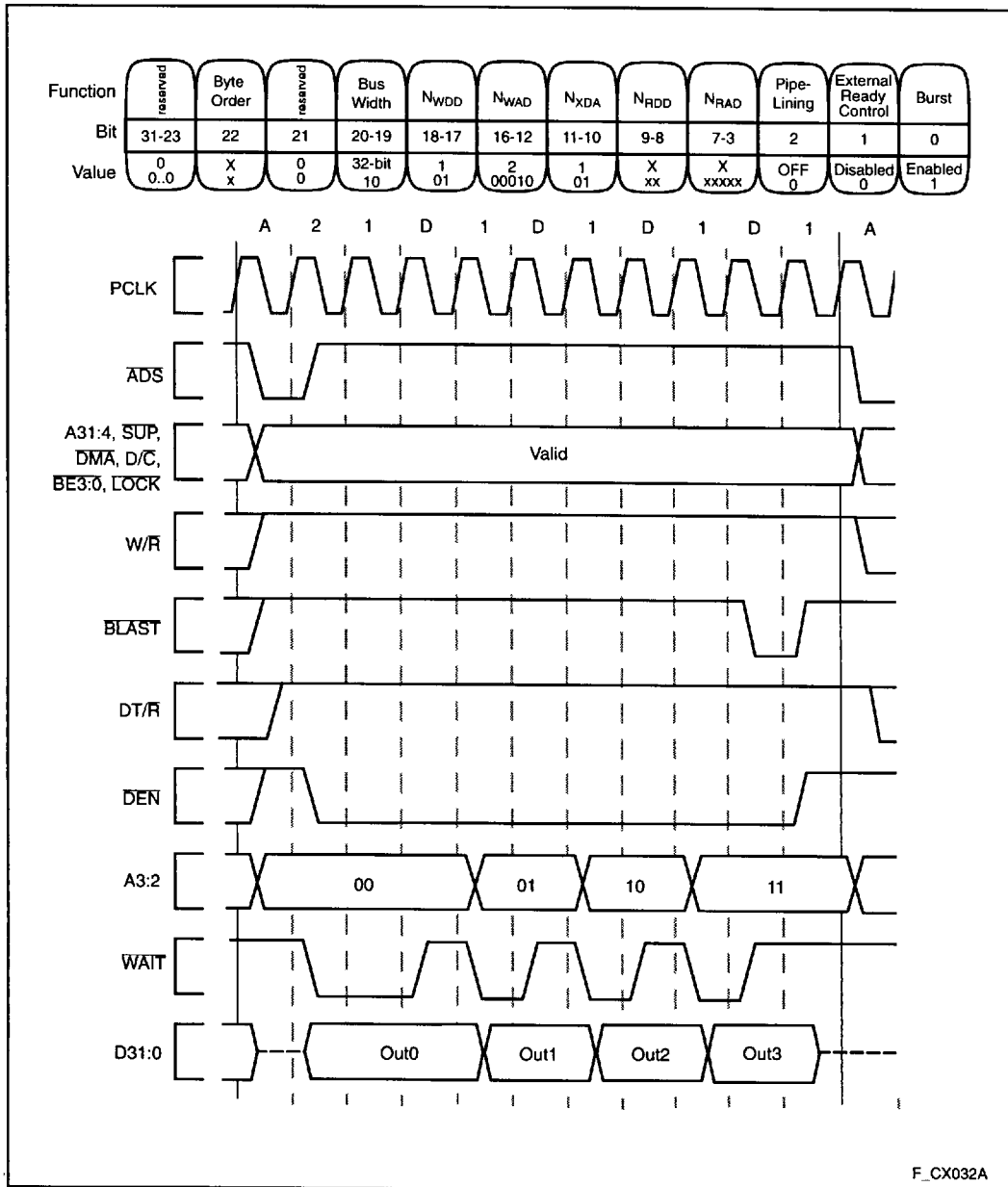

Figure 31. Burst, Non-Pipelined Write Request With Wait States, 32-Bit Bus

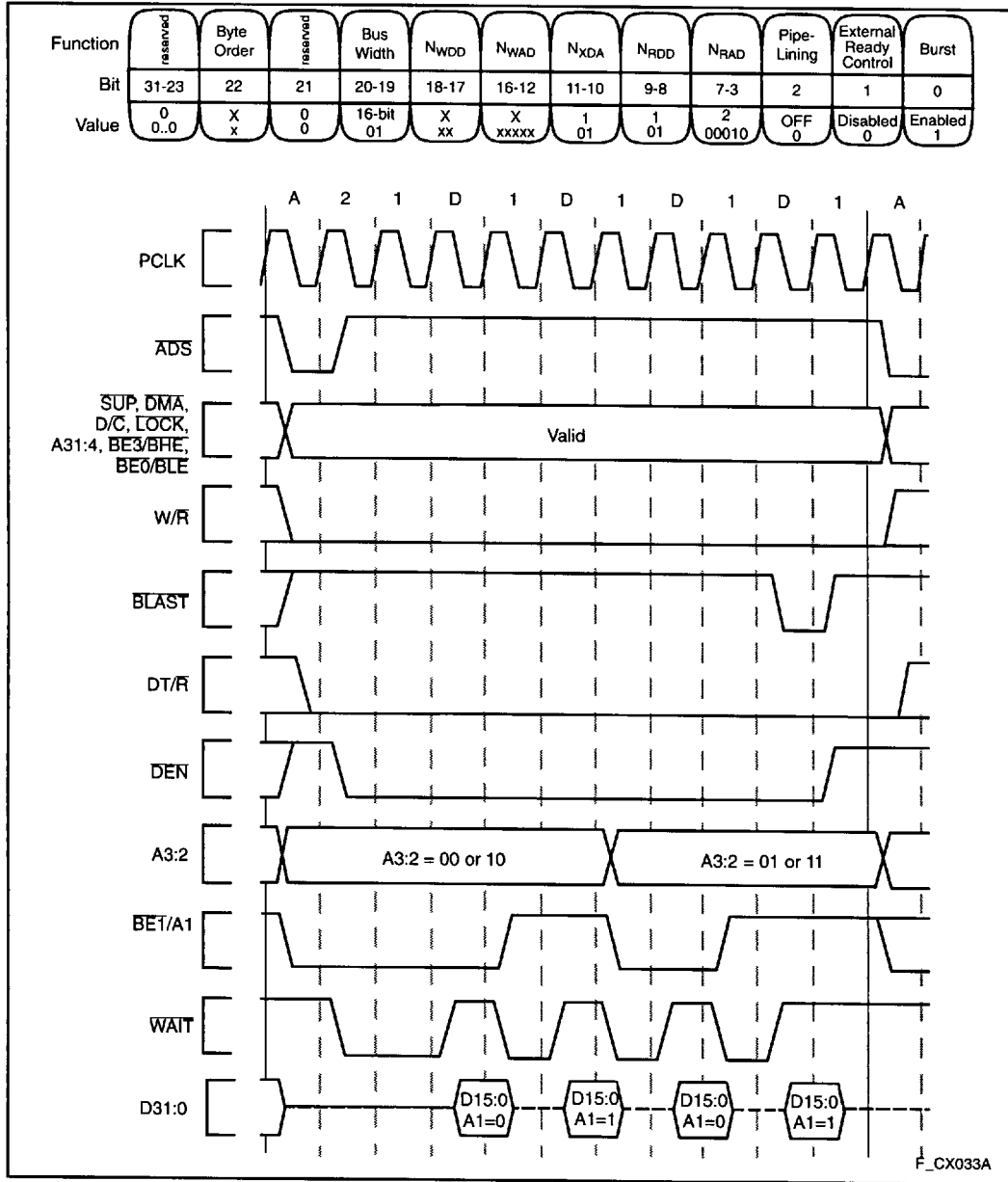

Figure 32. Burst, Non-Pipelined Read Request With Wait States, 16-Bit Bus

PRELIMINARY

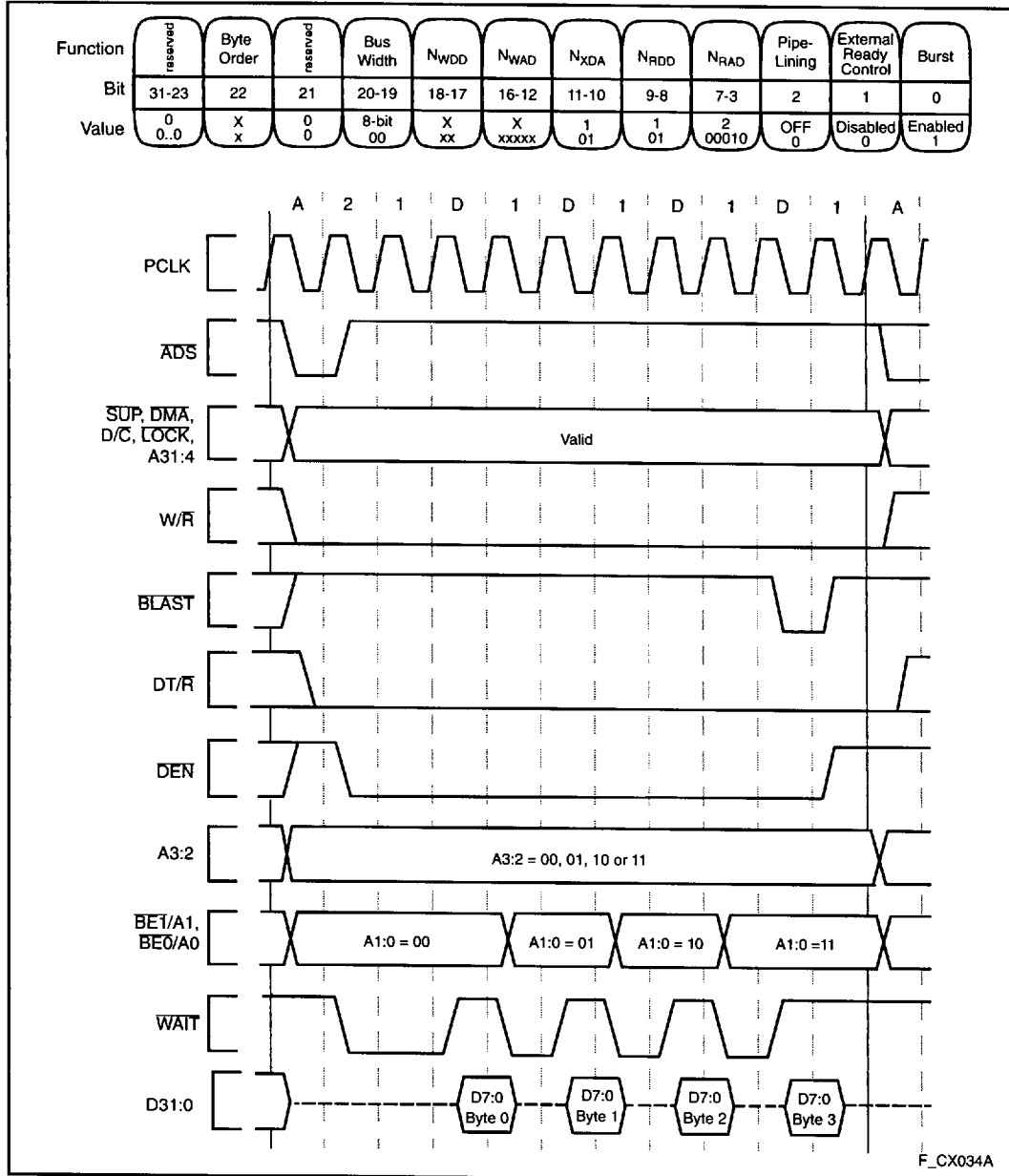

Figure 33. Burst, Non-Pipelined Read Request With Wait States, 8-Bit Bus

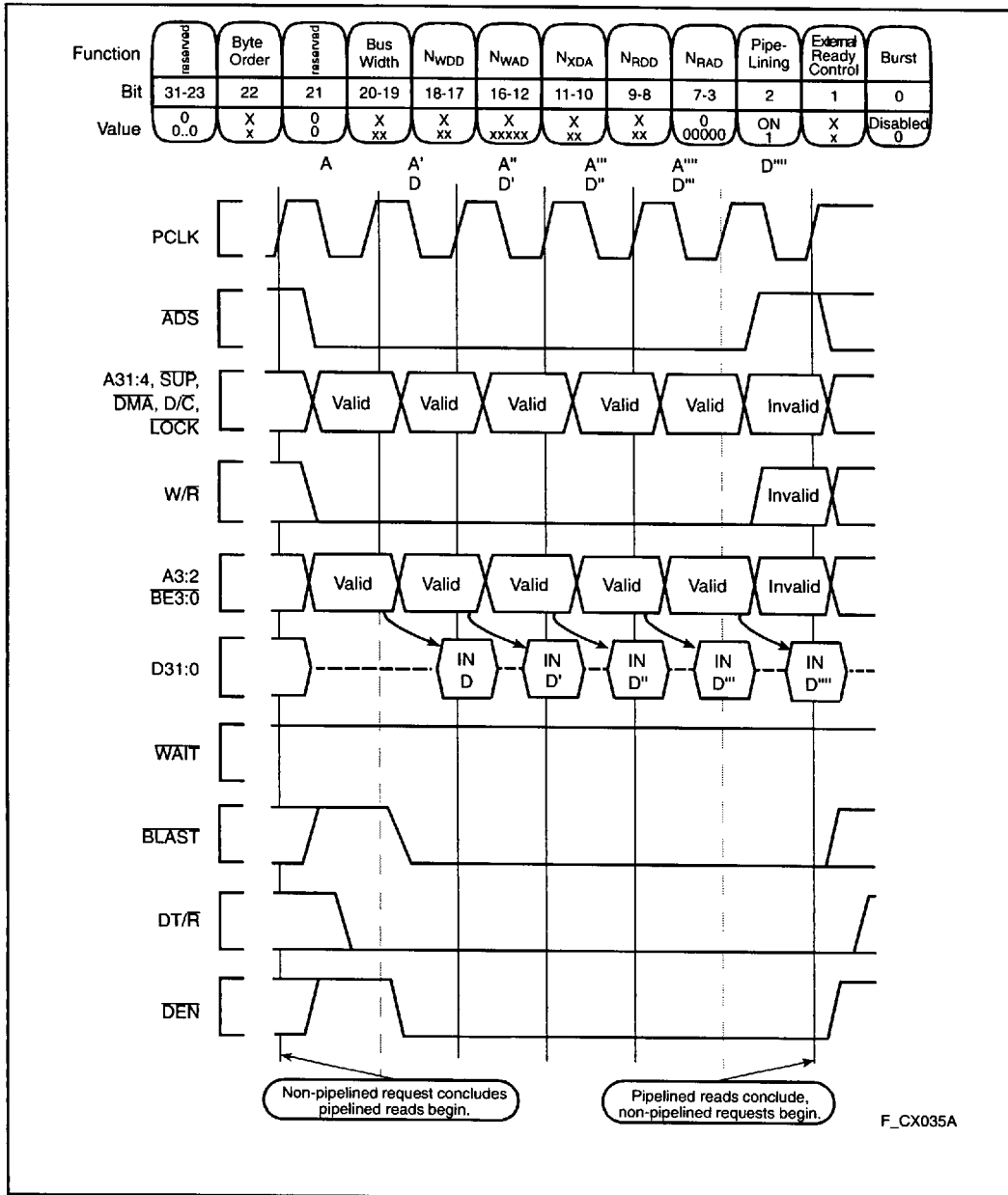

Figure 34. Non-Burst, Pipelined Read Request Without Wait States, 32-Bit Bus

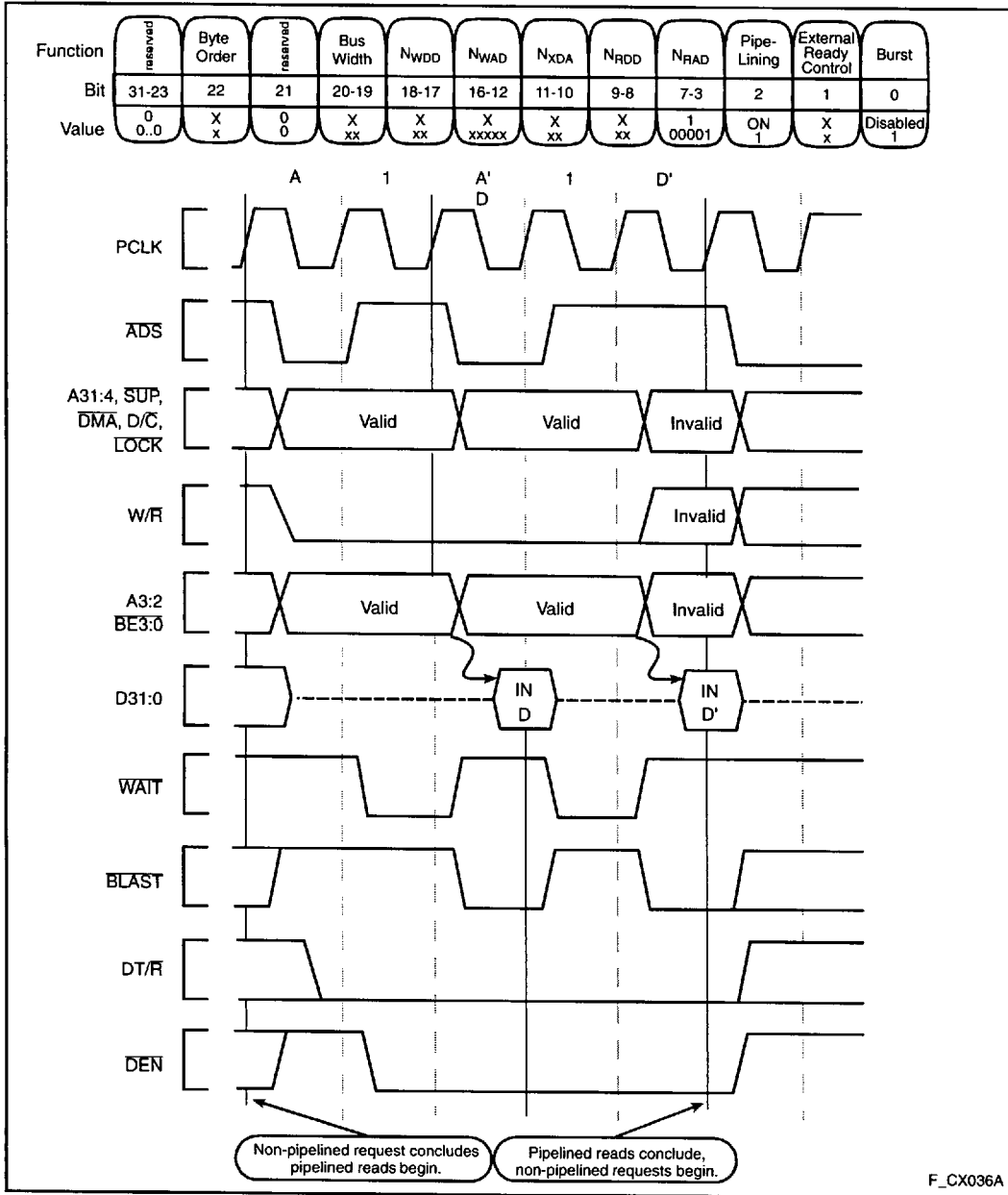

Figure 35. Non-Burst, Pipelined Read Request With Wait States, 32-Bit Bus

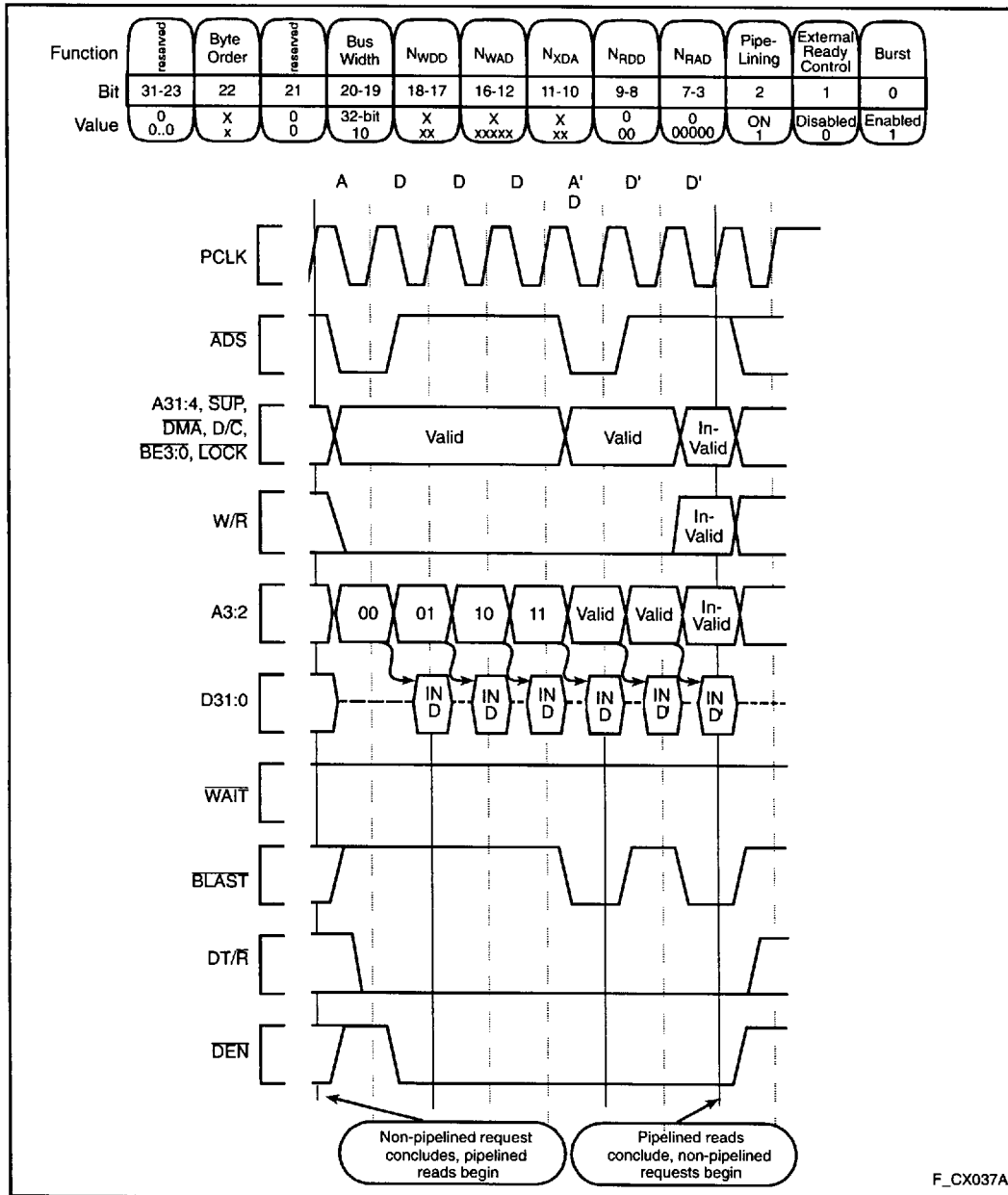

Figure 36. Burst, Pipelined Read Request Without Wait States, 32-Bit Bus

PRELIMINARY

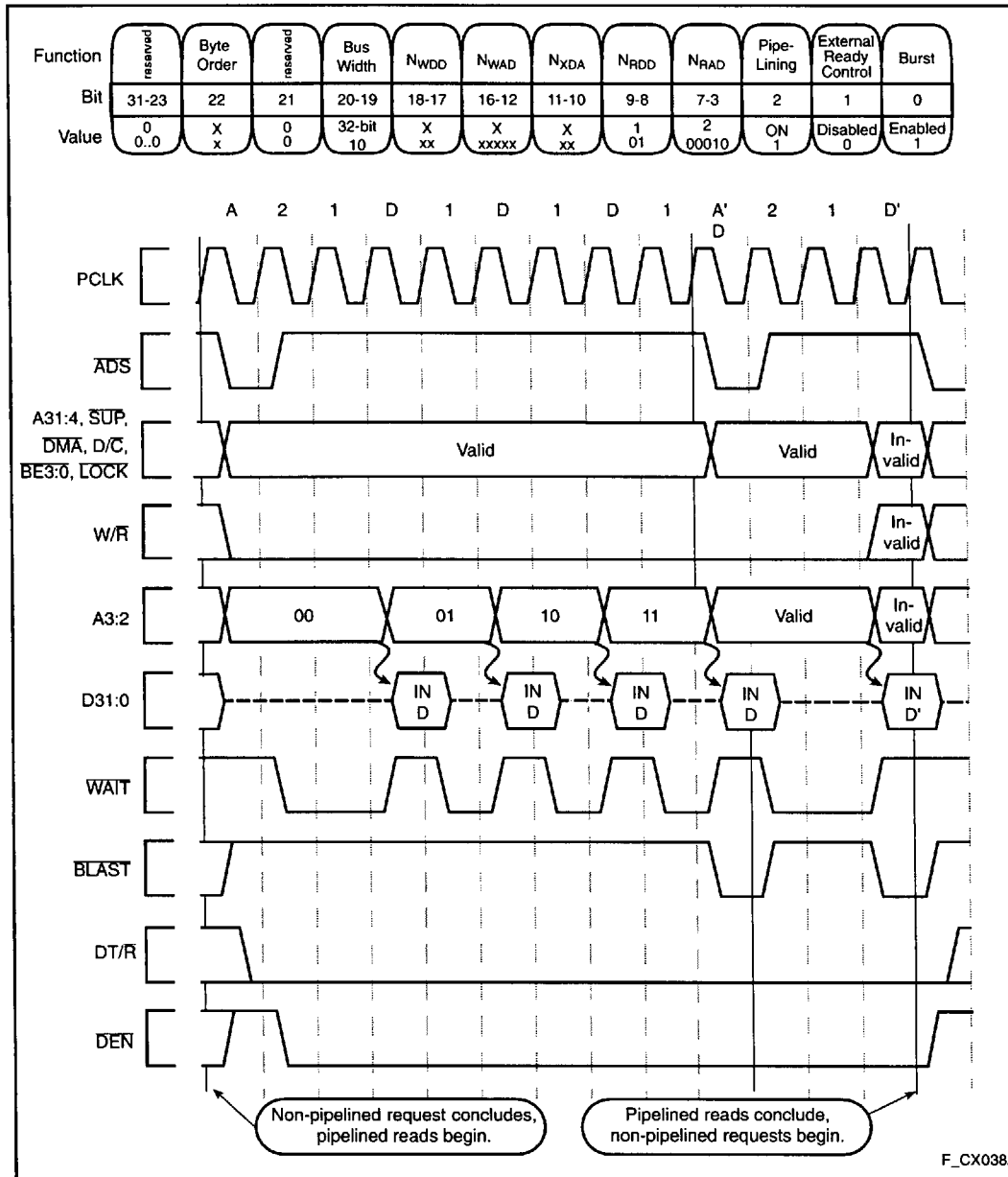

Figure 37. Burst, Pipelined Read Request With Wait States, 32-Bit Bus

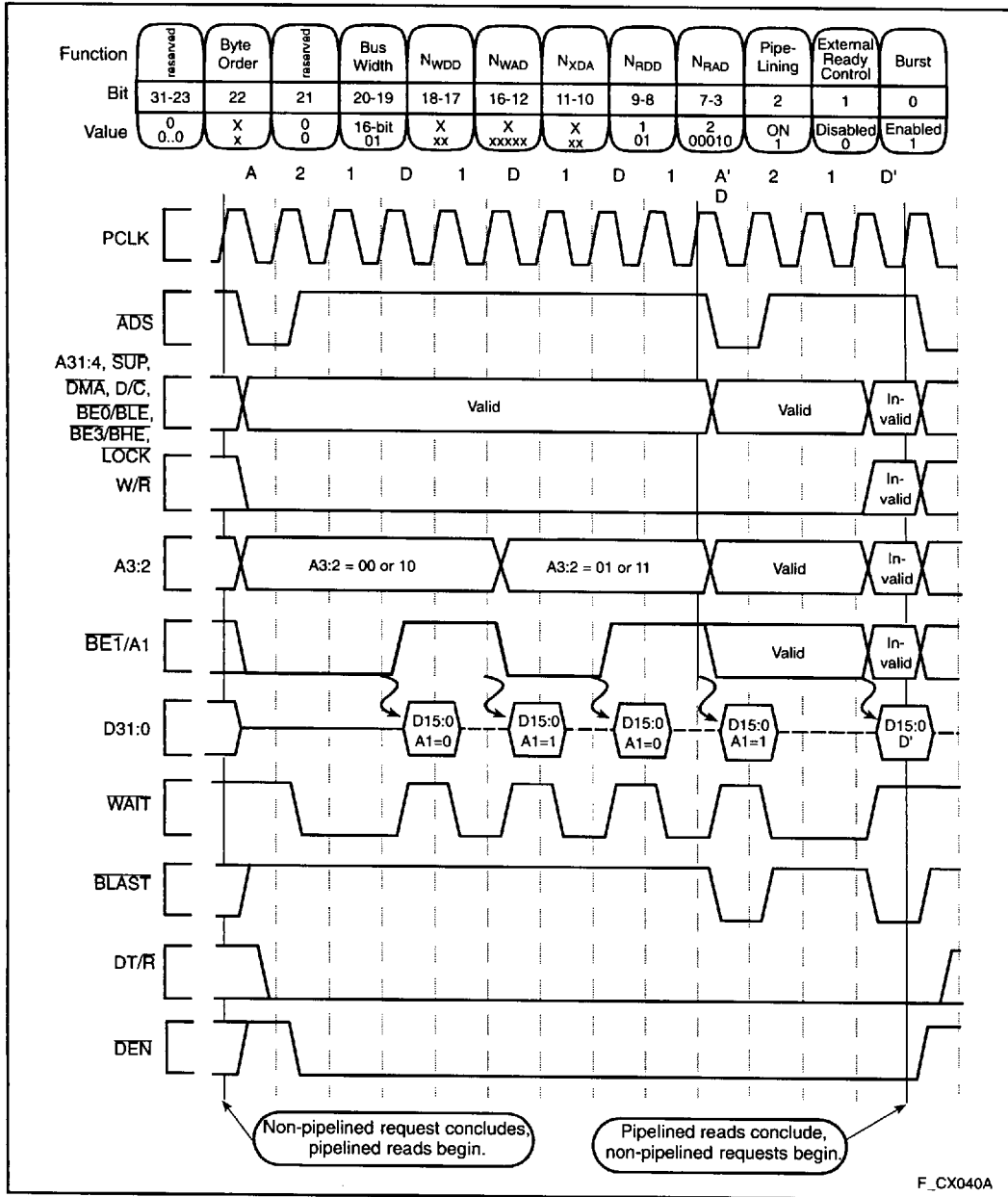

Figure 38. Burst, Pipelined Read Request With Wait States, 16-Bit Bus

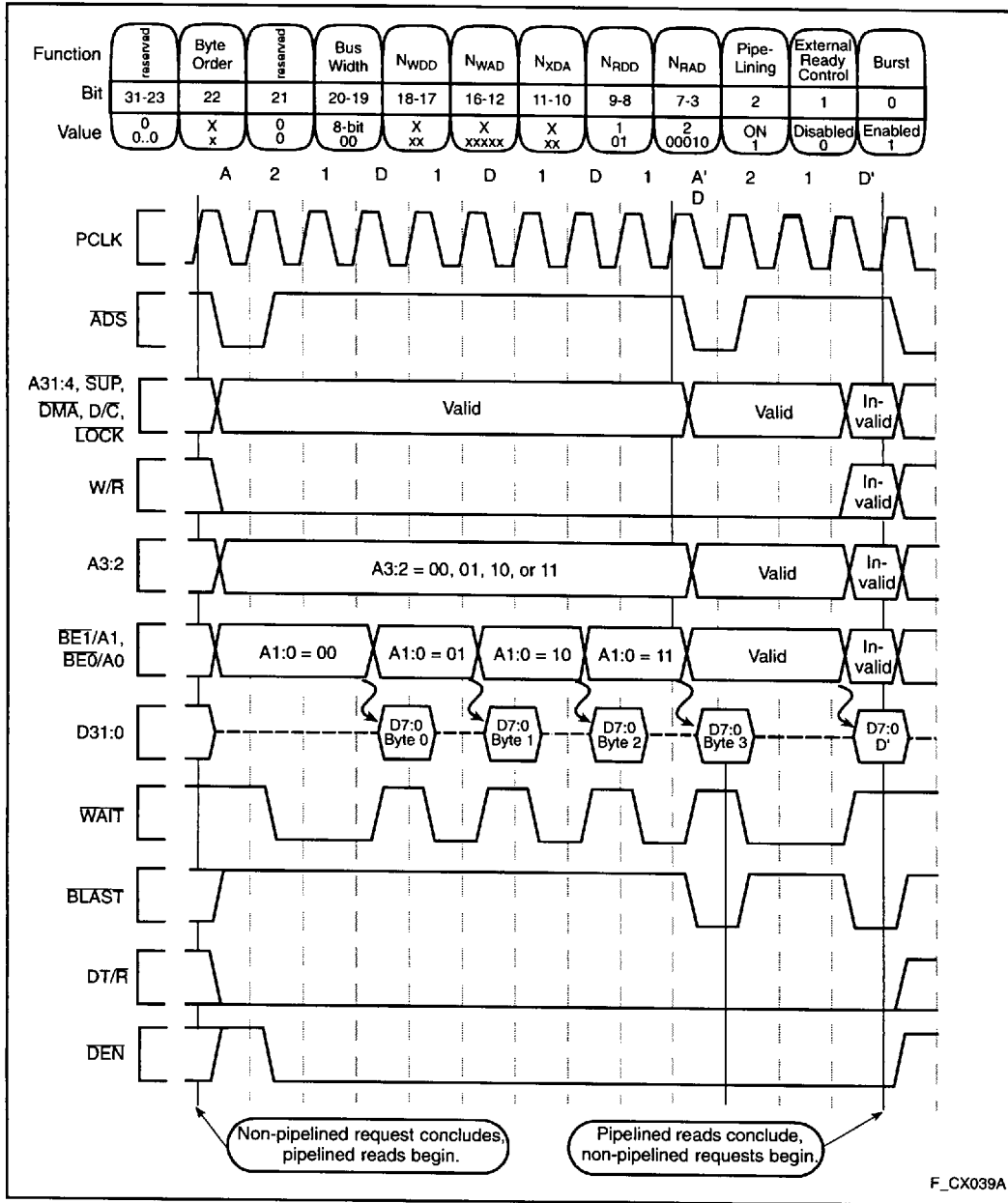

Figure 39. Burst, Pipelined Read Request With Wait States, 8-Bit Bus

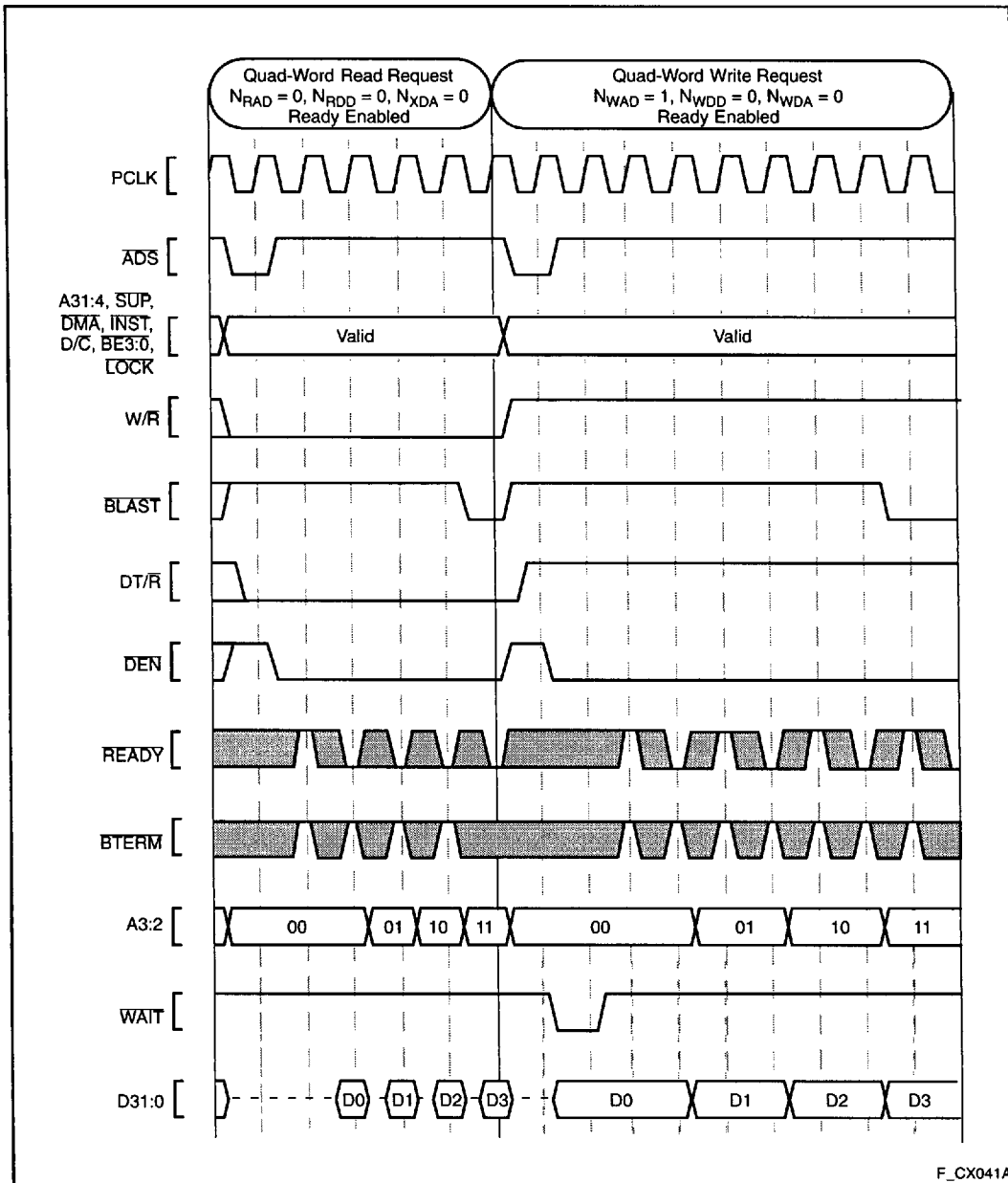

Figure 40. Using External READY

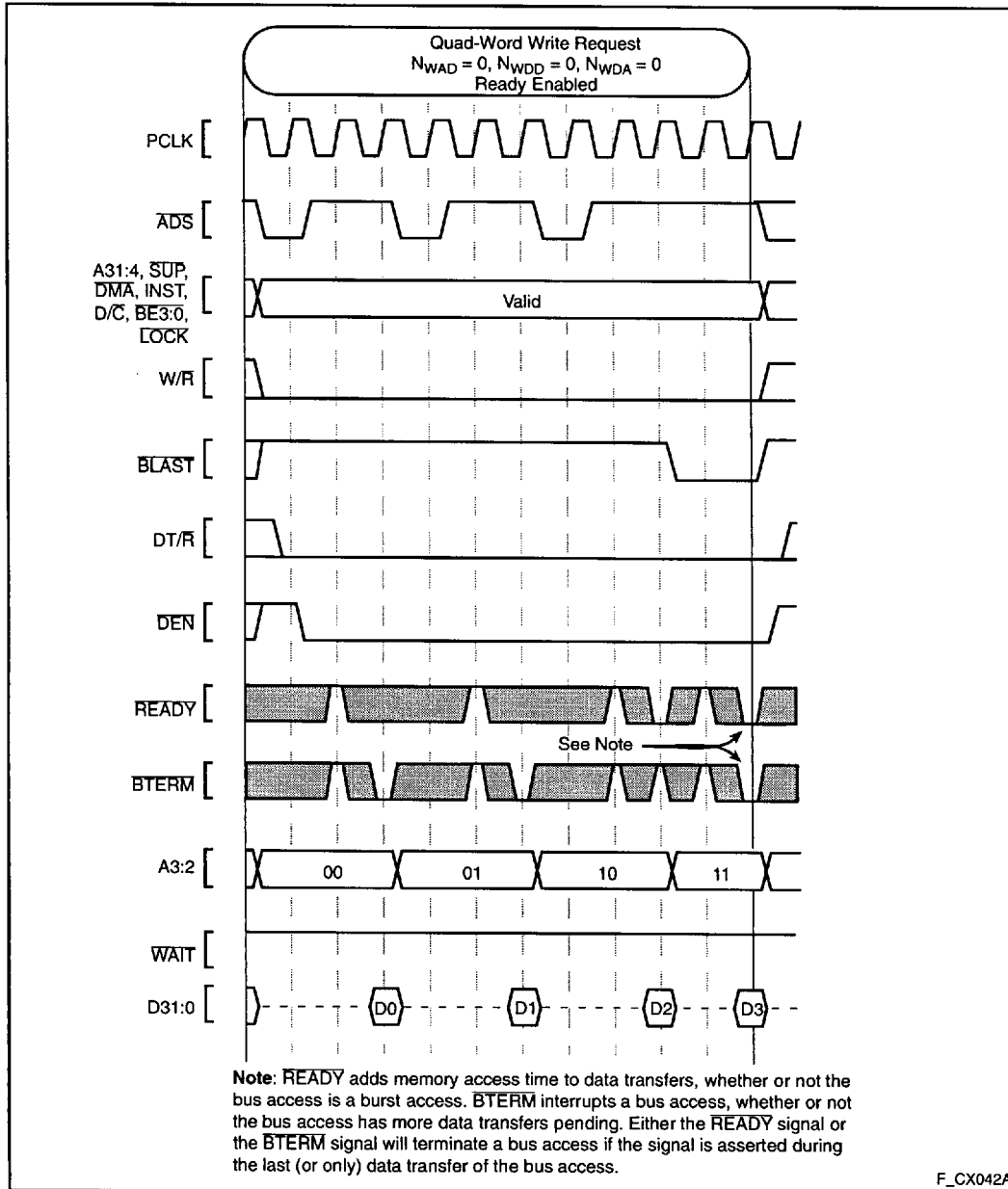

Figure 41. Terminating a Burst with BTERM

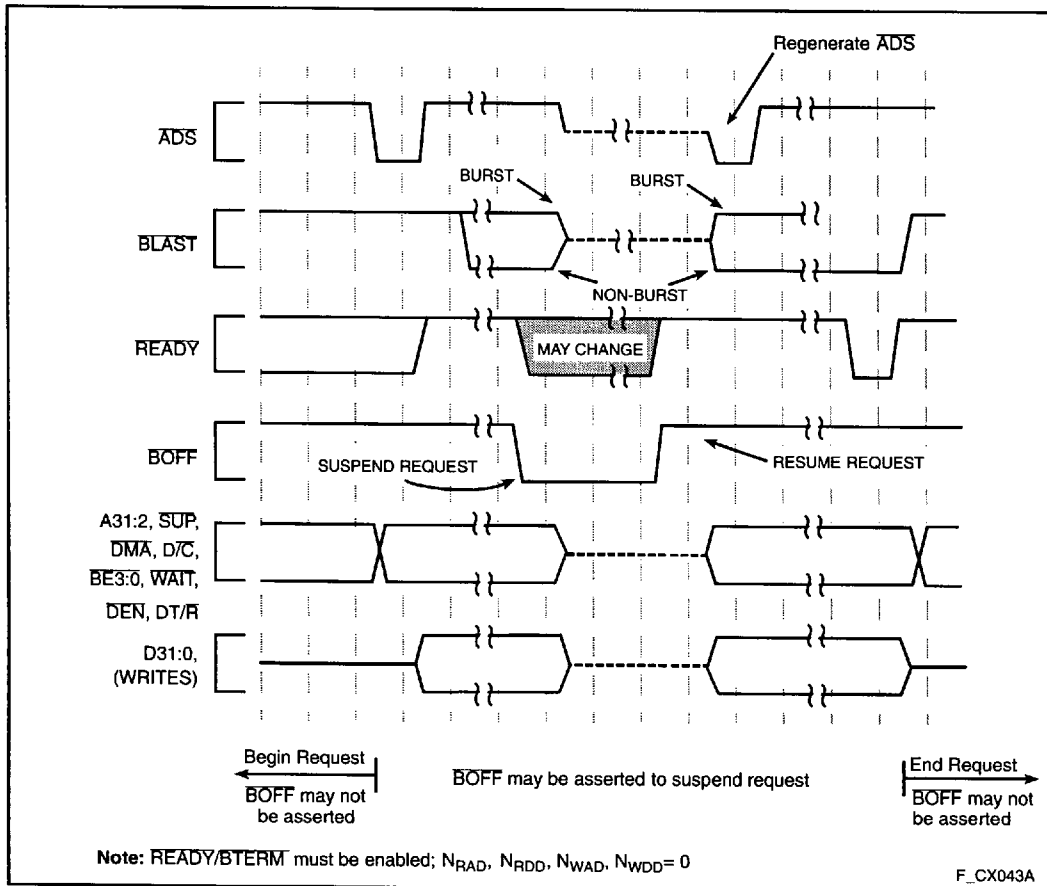

Figure 42. BOFF Functional Timing

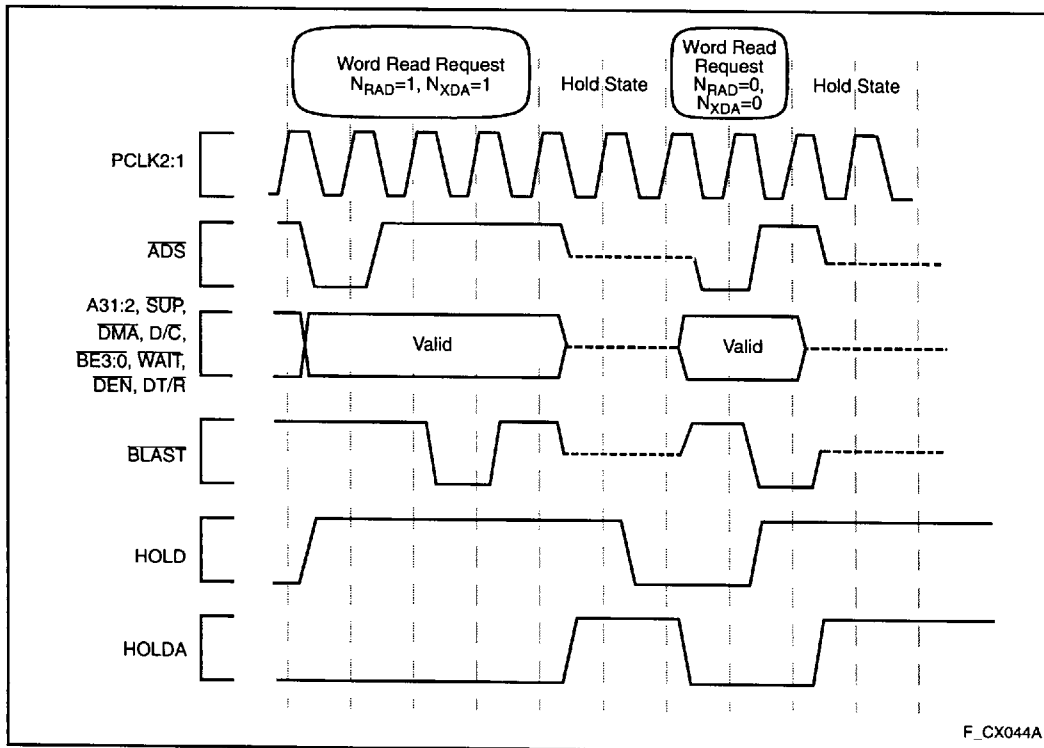

Figure 43. HOLD Functional Timing

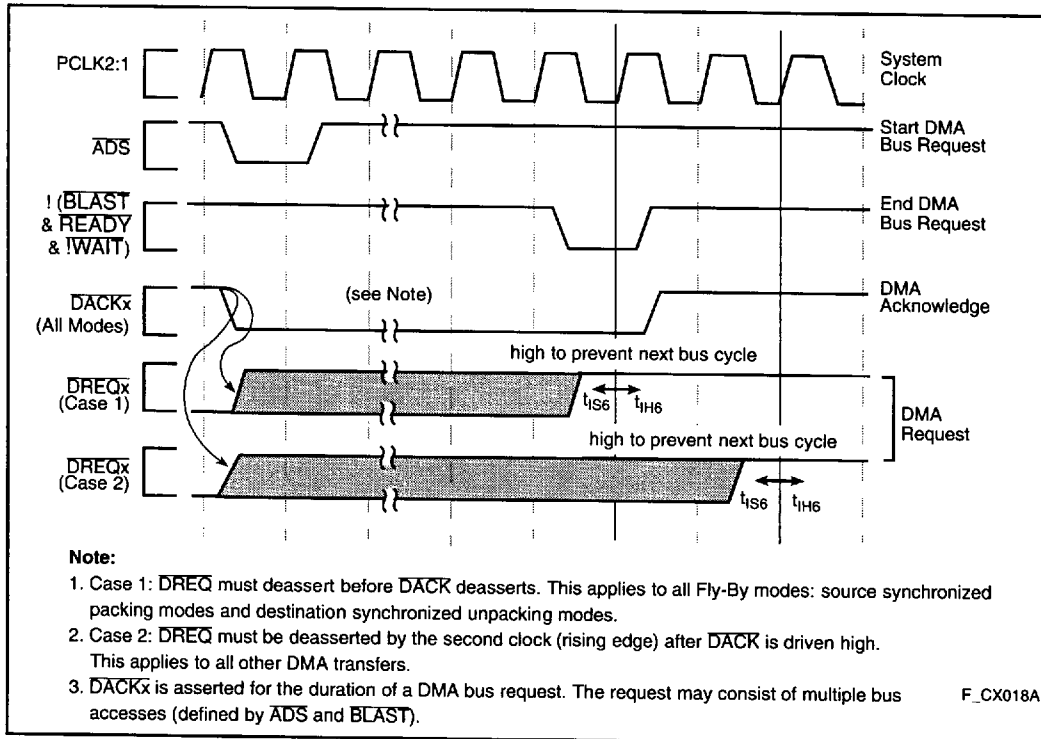

Figure 44. DREQ and DACK Functional Timing

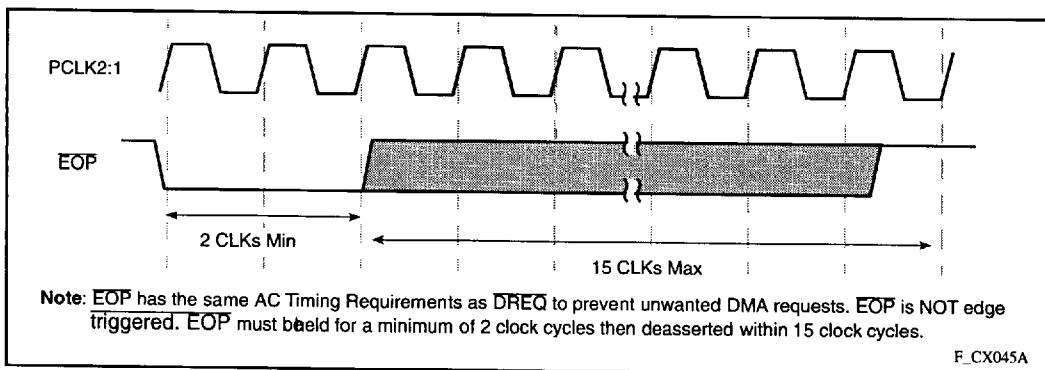

Figure 45. EOP Functional Timing

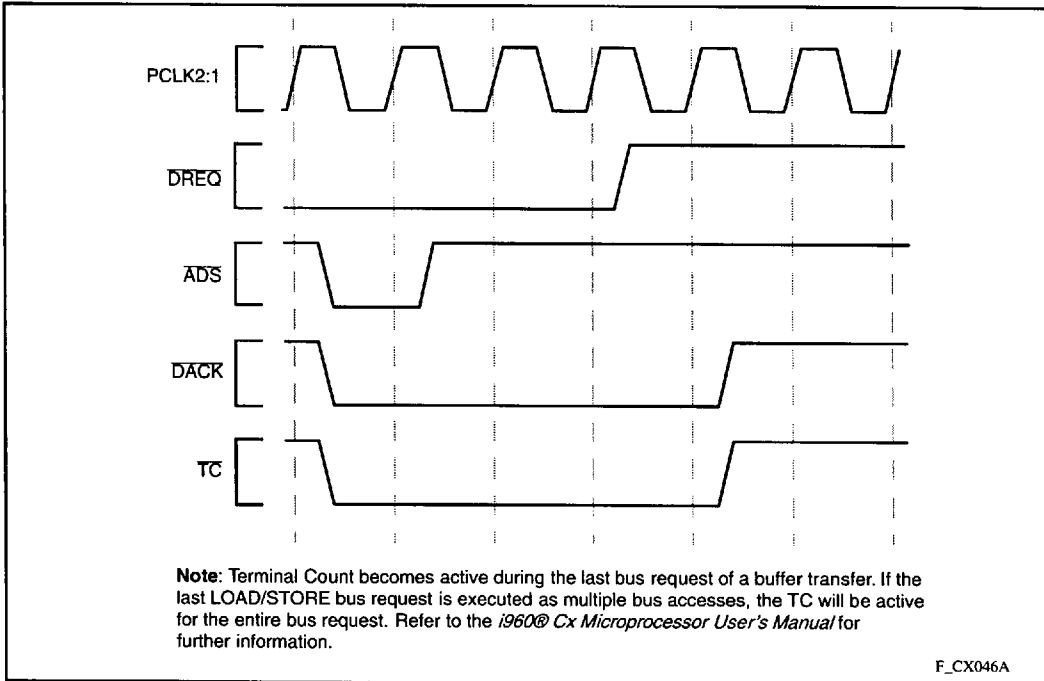

Figure 46. Terminal Count Functional Timing

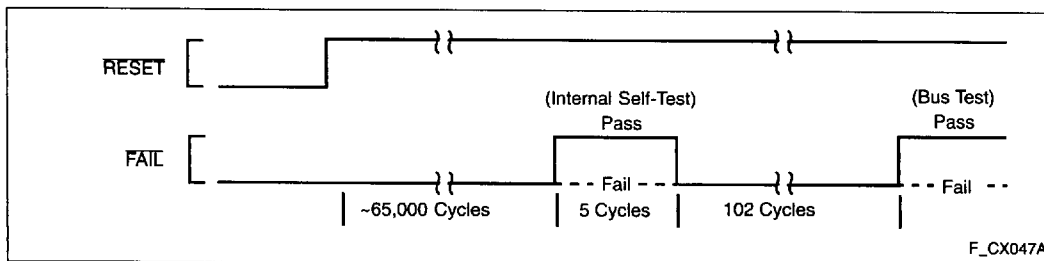

Figure 47. FAIL Functional Timing

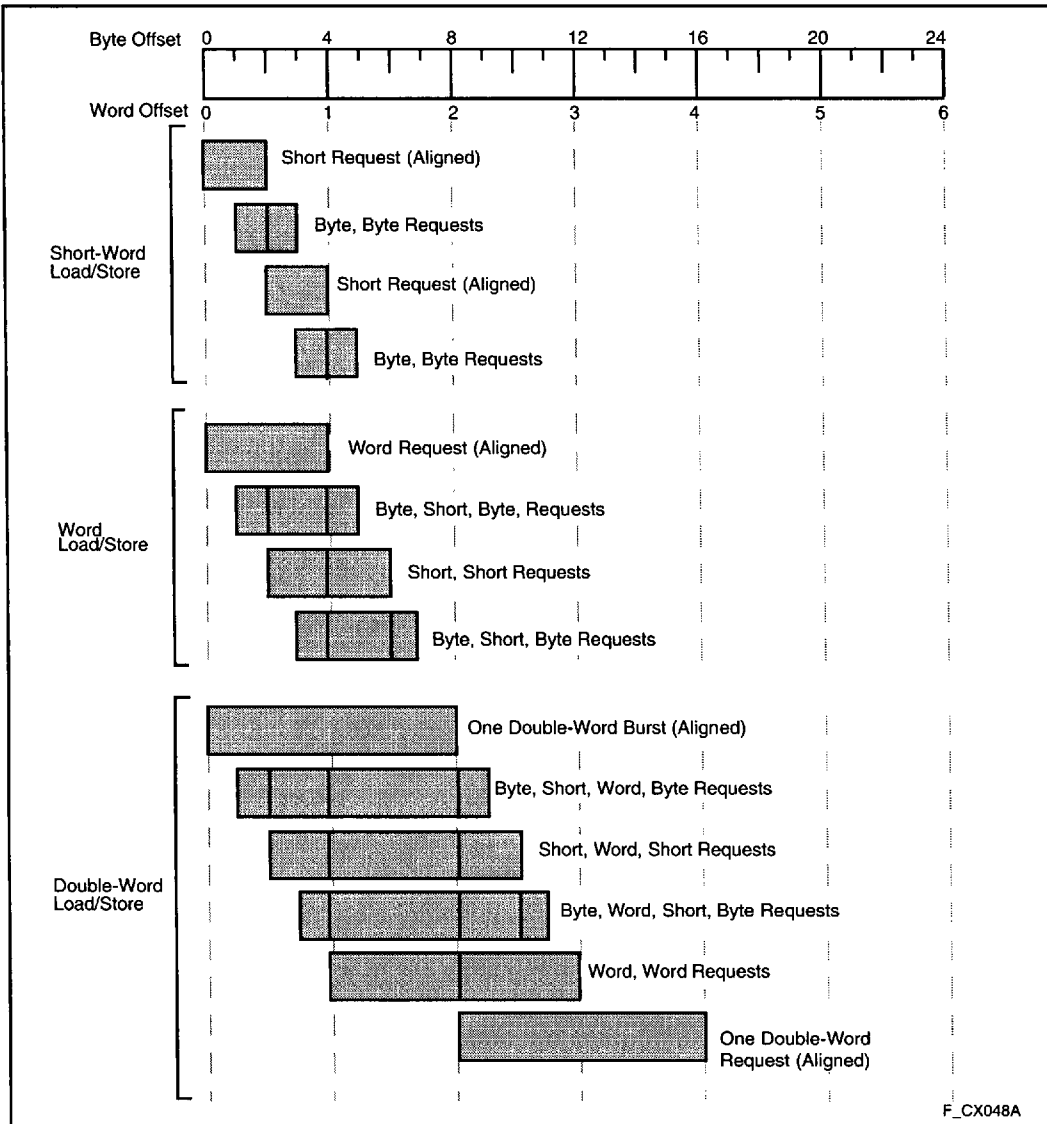

Figure 48. A Summary of Aligned and Unaligned Transfers for Little Endian Regions

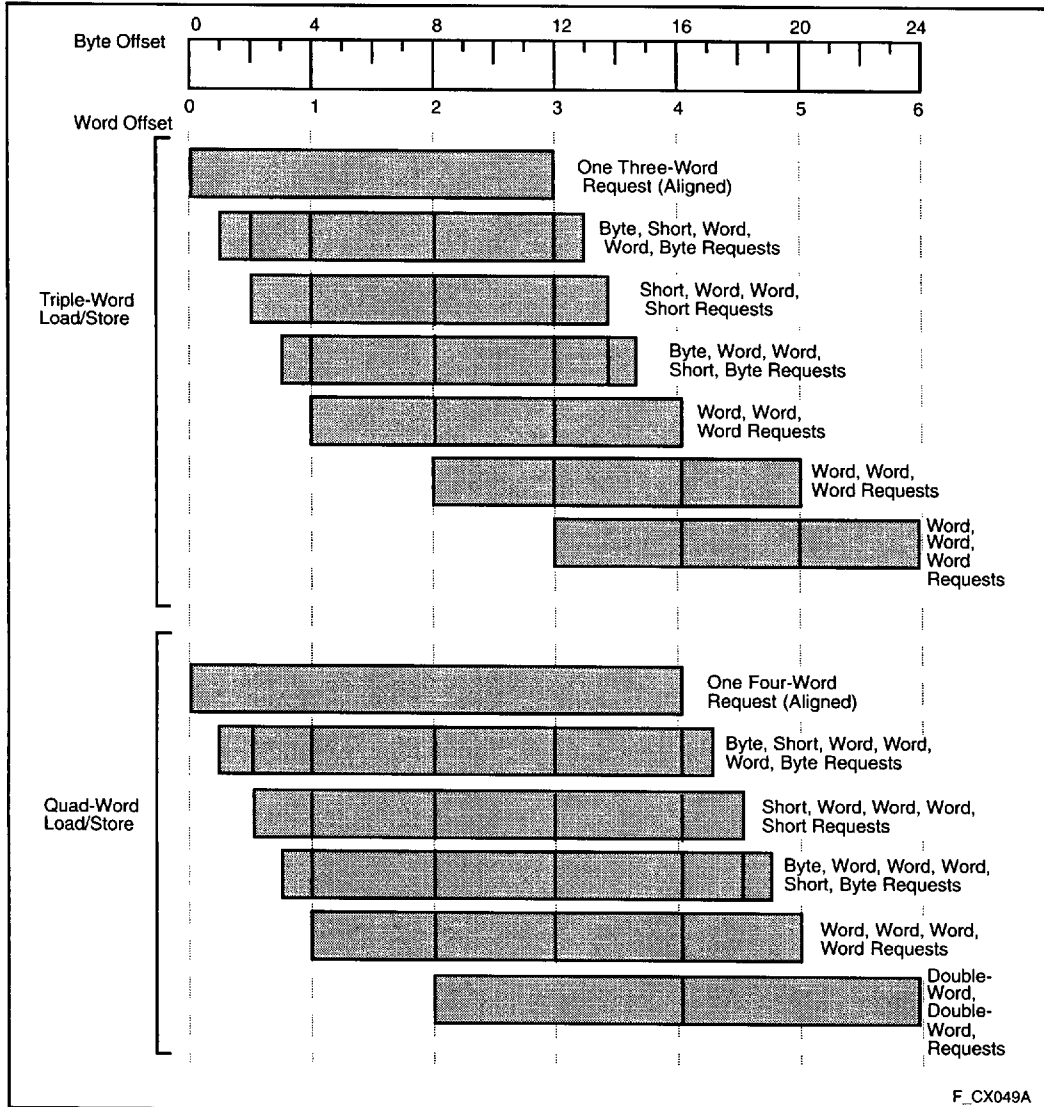

Figure 49. A Summary of Aligned and Unaligned Transfers for Little Endian Regions (Continued)

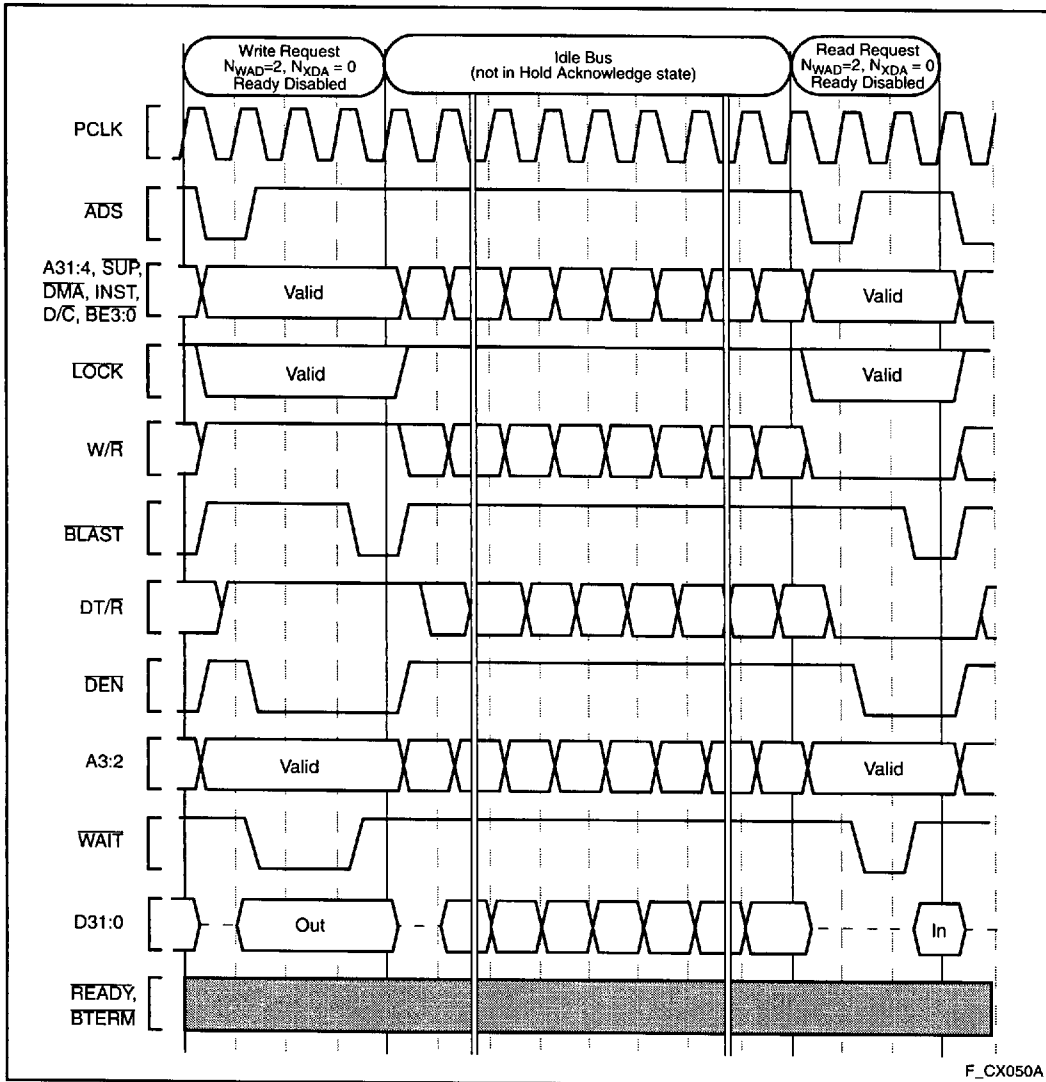

Figure 50. Idle Bus Operation

7.0 REVISION HISTORY

This is a new data sheet for the 80960CF-40 product. It is derived from the 80960CF-33, -25, -16 data sheet. Aside from a few minor edits, only the AC Characteristics differ from the 80960CF-33, -25, -16 data sheet.

PRELIMINARY