

HIGH SPEED SWITCHING APPLICATIONS

Features

- Low Gate Threshold Voltage
- Low C_{RSS} : $C_{RSS}=2.0\text{pF(Typ.)}$
- Voltage controlled small signal switch
- Low $R_{DS(on)}$: $R_{DS(on)}=5\Omega(\text{Max.})$

Ordering Information

Type No.	Marking	Package Code
STK7002	<u>K702</u> □ ① ②	SOT-23

PIN Connection

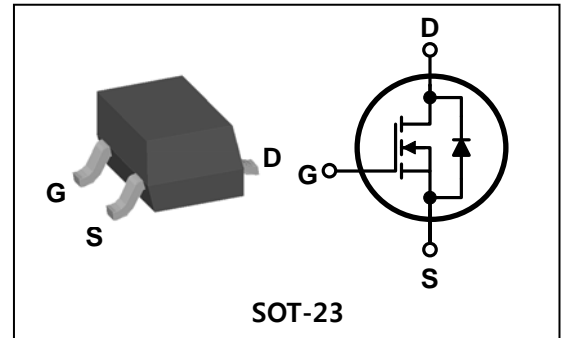

Marking Diagram

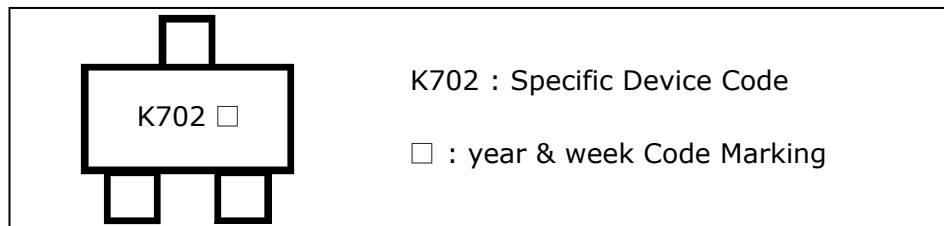

Absolute maximum ratings ($T_A=25^\circ\text{C}$ unless otherwise noted)

Characteristic	Symbol	Rating	Unit
Drain-source voltage	V_{DSS}	60	V
Gate-source voltage	V_{GSS}	± 20	V
Drain current (DC) *	I_D	115	mA
Drain current (Pulsed) *	I_{DM}	800	mA
Junction temperature	T_J	150	°C
Storage temperature range	T_{stg}	-55~150	

* Limited by maximum junction temperature

Thermal Characteristics

Characteristic	Symbol	Rating	Unit
Power dissipation	P_D	350	mW
Thermal resistance, Junction-Ambient *	$R_{th(J-A)}$	357	°C/W

* Device mounted on FR-4 PCB, 99.5% Alumina 10 x 8 x 0.6mm. Minimum land pad size

Electrical Characteristics (T_A=25°C unless otherwise noted)

Characteristic	Symbol	Test Condition	Min.	Typ.	Max.	Unit
Off Characteristics (Note1)						
Drain-source breakdown voltage	BV _{DSS}	I _D =10uA, V _{GS} =0	60	-	-	V
Drain-source cut-off current	I _{DSS}	V _{DS} =60V, V _{GS} =0	-	-	1.0	uA
		V _{DS} =60V, V _{GS} =0, @T _C =125°C	-	-	200	
Gate leakage current	I _{GSS}	V _{DS} =0V, V _{GS} =±20V	-	-	±100	nA
On Characteristics (Note1)						
Gate threshold voltage	V _{GS(th)}	I _D =250uA, V _{DS} =V _{GS}	1.0	2.0	2.5	V
Drain-source on-resistance	R _{DS(ON)}	V _{GS} =10V, I _D =500mA	-	2.4	5.0	Ω
		V _{GS} =5V, I _D =50mA	-	3.2	5.0	
Forward transfer conductance	g _{fs}	V _{DS} =10V, I _D =100mA	80	-	-	mS
Dynamic Characteristics						
Input capacitance	C _{iss}	V _{GS} =0V, V _{DS} =25V, f=1MHz	-	22	-	pF
Output capacitance	C _{oss}		-	11	-	
Reverse transfer capacitance	C _{rss}		-	2	-	
Switching Characteristics						
Turn-on delay time	t _{D(ON)}	V _{DD} =30V, I _D =100mA V _{GS} =10V, R _G =25Ω	-	7	-	ns
Turn-off delay time	t _{D(OFF)}		-	11	-	

Note1 : Short duration test pulse used to minimize self-heating effect.

Electrical Characteristic Curves

Fig. 1 $I_D - V_{DS}$

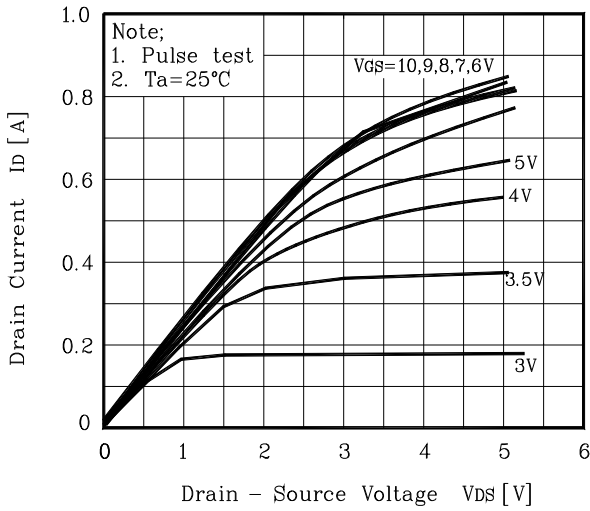

Fig. 2 $I_D - V_{GS}$

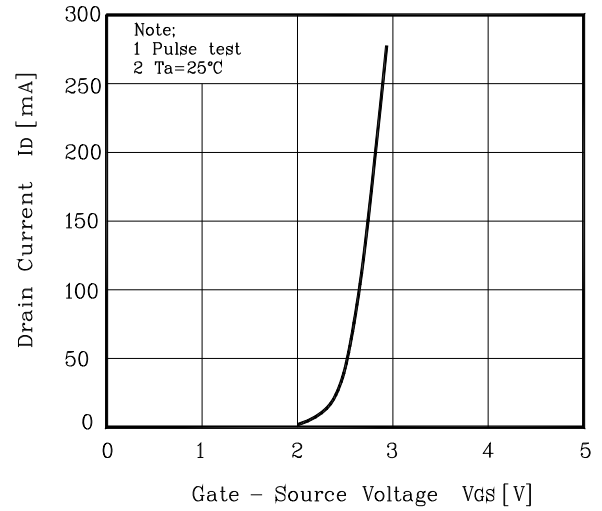

Fig. 3 $R_{DS(on)} - I_D$

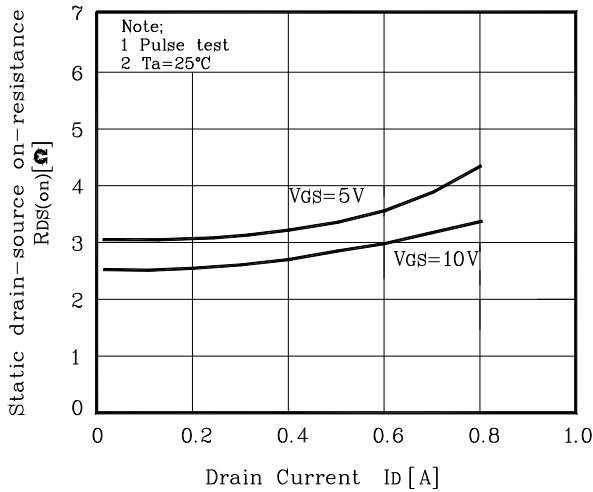

Fig. 4 $R_{DS(on)} - V_{GS}$

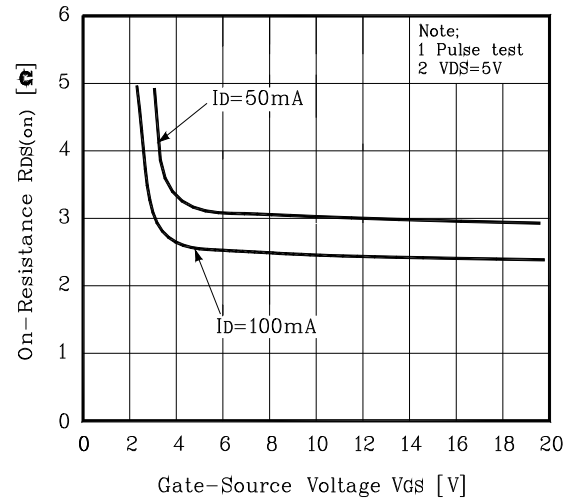

Fig. 5 Capacitance - V_{DS}

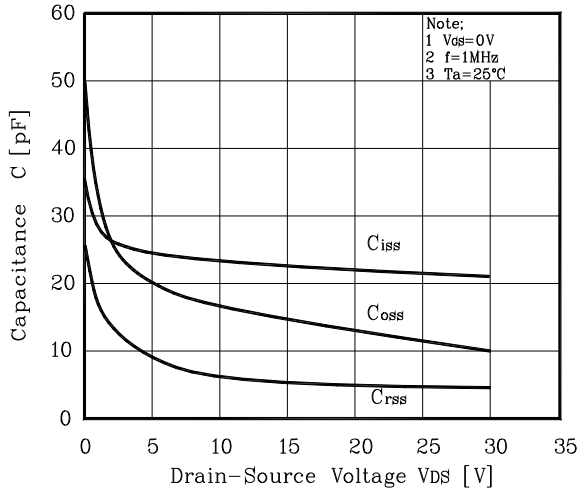
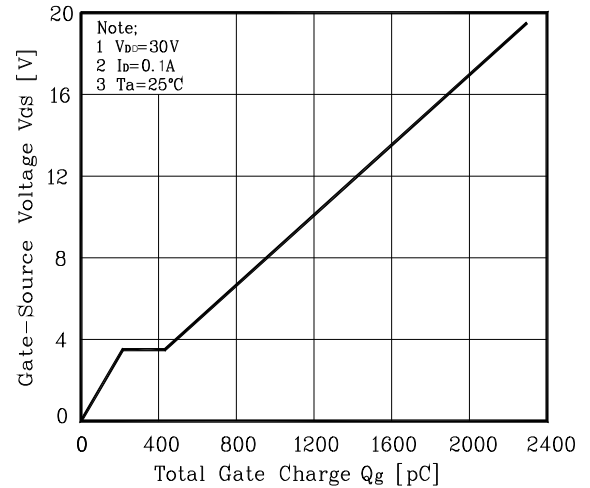

Fig. 6 $V_{GS} - Q_g$



Electrical Characteristic Curves

Fig. 7 $I_s - V_{SD}$

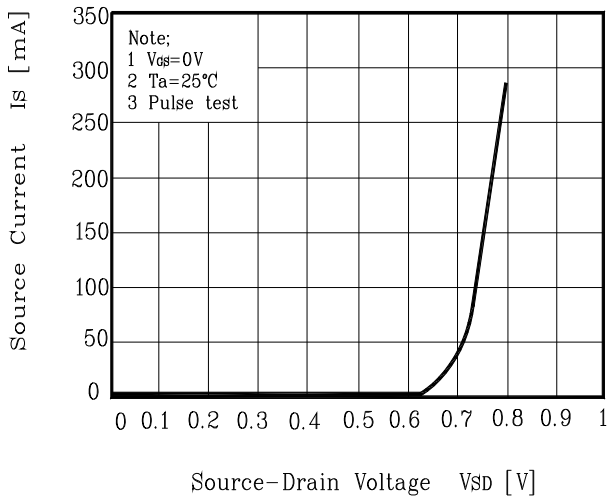
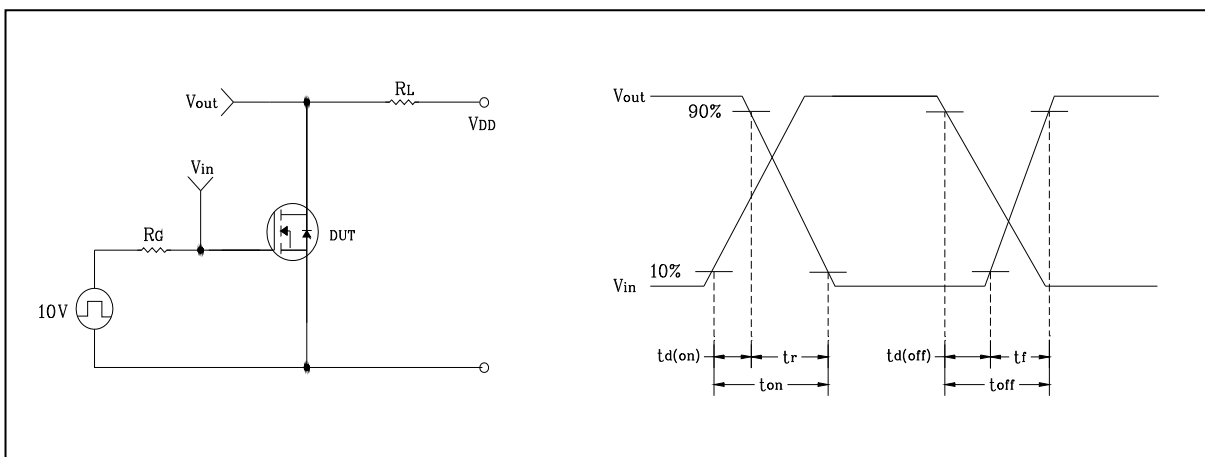
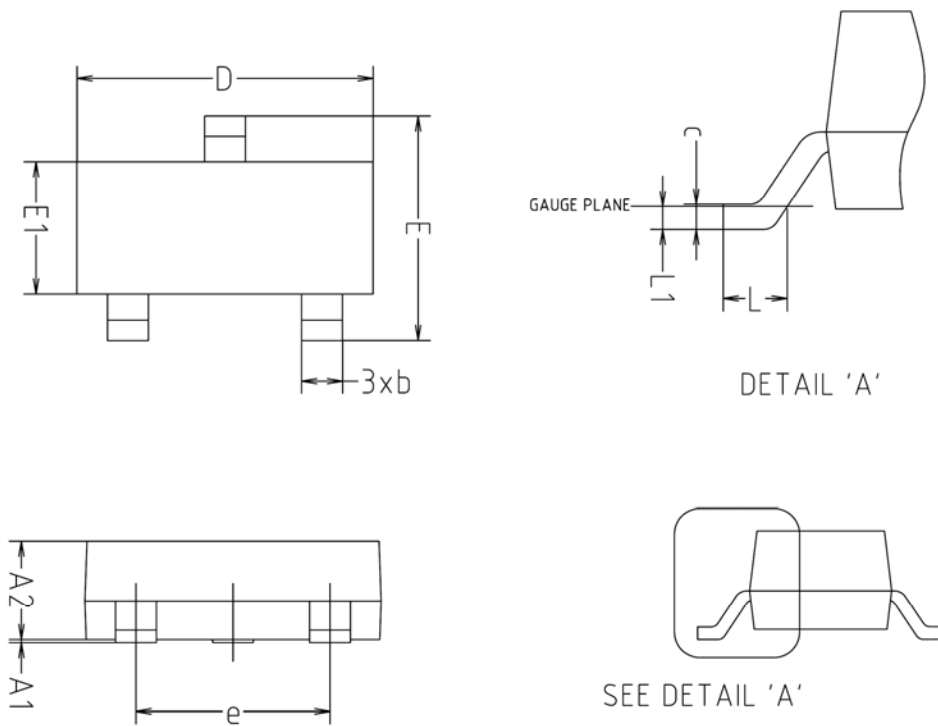

Fig. 8 Resistive Switching Test Circuit & Waveform



Outline Dimension

unit: mm



SYMBOL	MILLIMETERS			NOTE
	MINIMUM	NOMINAL	MAXIMUM	
A1	0.00	-	0.10	
A2	0.82	-	1.02	
b	0.39	0.42	0.45	
c	0.09	0.12	0.15	
D	2.80	2.90	3.00	
E	2.20	2.40	2.60	
E1	1.20	1.30	1.40	
e	1.90BSC			
L	0.20	-	-	
L1	0.12BSC			

※ Recommended Land Pattern [unit: mm]

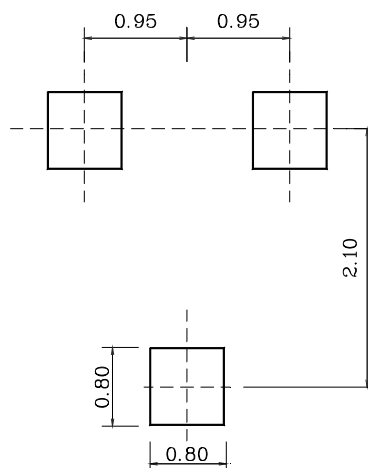

The AUK Corp. products are intended for the use as components in general electronic equipment (Office and communication equipment, measuring equipment, home appliance, etc.).

Please make sure that you consult with us before you use these AUK Corp. products in equipments which require high quality and / or reliability, and in equipments which could have major impact to the welfare of human life(atomic energy control, airplane, spaceship, transportation, combustion control, all types of safety device, etc.). AUK Corp. cannot accept liability to any damage which may occur in case these AUK Corp. products were used in the mentioned equipments without prior consultation with AUK Corp..

Specifications mentioned in this publication are subject to change without notice.