

EE-SPZ

Optical Fiber Photomicrosensor resists interference from external light.

- Easy adjustment and optical axis monitoring with a light indicator.
- Wide operating voltage range: 5 to 24 VDC
- Supports connection with Programmable Controllers (PLCs).
- Easy-to-wire connectors assure easy maintenance.









 Be sure to read *Safety Precautions* on page 5.

Ordering Information

Sensors

 Infrared light

Appearance	Sensing method	Sensing distance	Output type	Output configuration	Model
	Through-beam type (with lens)	 30 mm	NPN output	Dark-ON	EE-SPZ301W-01
				Light-ON	EE-SPZ401W-01
	Through-beam type	 5 mm		Dark-ON	EE-SPZ301W-02
				Light-ON	EE-SPZ401W-02
	Reflective type	 1 to 3 mm		Dark-ON	EE-SPZ301Y-01
				Light-ON	EE-SPZ401Y-01

Accessories (Order Separately)

Type	Cable length	Model	Remarks
Connector		EE-1002	
Connector with Cable	1 m	EE-1003	
NPN/PNP Conversion Connector	0.46 m (total length)	EE-2001	
Connector Hold-down Clip		EE-1003A	For EE-1003 only.

Ratings and Specifications

Item	Sensing method	Through-beam (with lens)	Through-beam	Reflective
	Models	EE-SPZ301W-01 EE-SPZ401W-01	EE-SPZ301W-02 EE-SPZ401W-02	EE-SPZ301Y-01 EE-SPZ401Y-01
Sensing distance		30 mm	5 mm	1 to 3 mm White paper (15 × 15 mm) (reflection factor: 90%)
Sensing object		Opaque: 4 mm dia. min.	Opaque: 1 mm dia. min.	---
Light source	GaAs infrared LED with a peak wavelength of 940 nm			
Indicator *1	Light indicator (red)			
Supply voltage	5 to 24 VDC ±10%, ripple (p-p): 5% max.			
Current consumption	Average: 15 mA max., Peak: 50 mA max.			
Control output	NPN voltage output Load power supply voltage: 5 to 24 VDC Load current: 80 mA max. 80 mA load current with a residual voltage of 1.0 V max. 10 mA load current with a residual voltage of 0.4 V max.			
Response frequency *2	100 Hz min.			
Ambient illumination	3,000 lx max. with fluorescent light or incandescent light on the surface of the receiver			
Ambient temperature range	Operating: -10 to +55°C Storage: -25 to +65°C			
Ambient humidity range	Operating: 5% to 85% Storage: 5% to 95%			
Vibration resistance	Destruction: 10 to 55 Hz, 1.5-mm double amplitude for 2 h each in X, Y, and Z directions			
Shock resistance	Destruction: 500 m/s ² for 3 times each in X, Y, and Z directions			
Enclosure rating	IEC IP50			
Connecting method	Special connector (soldering not possible)			
Weight		Approx. 7.3 g	Approx. 7.0 g	Approx. 7.2 g
Material	Case, Lens: Polycarbonate, Fiber sheath: Black polyethylene			

*1. The indicator is a GaP red LED (peak wavelength: 700 nm).

*2. The response frequency was measured by detecting the following rotating disk.

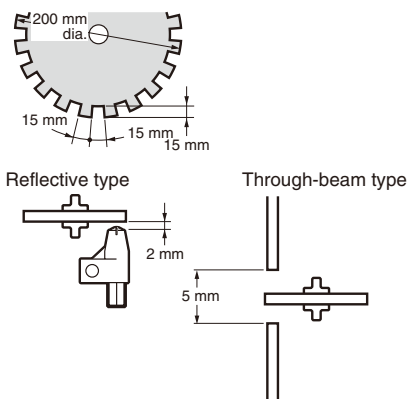

Engineering Data (Typical)

Receiver Output vs. Sensing Distance Characteristics

EE-SPZ301W-01, EE-SPZ401W-01

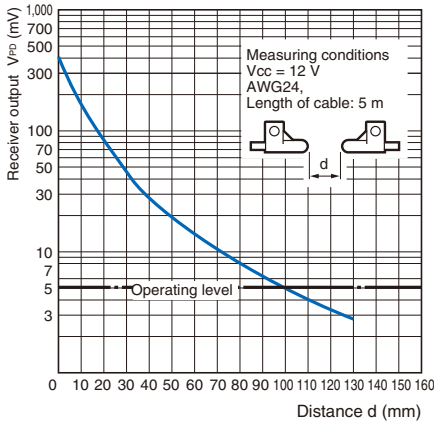

EE-SPZ301W-02, EE-SPZ401W-02

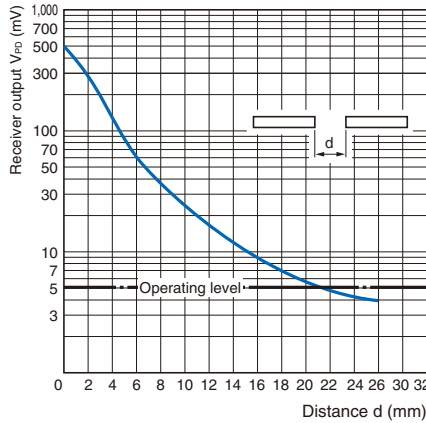

EE-SPZ301Y-01, EE-SPZ401Y-01

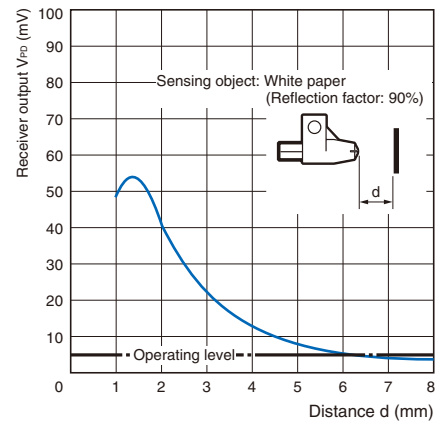

Sensing Angle vs. Sensing Distance Characteristics

EE-SPZ301Y-01, EE-SPZ401Y-01

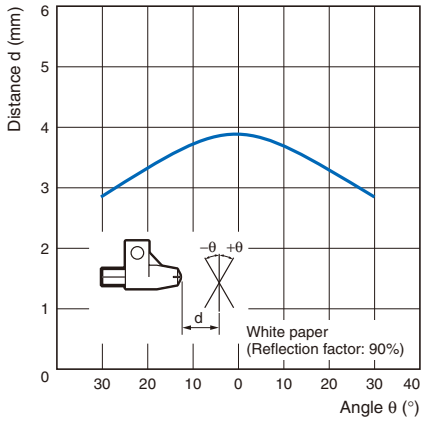

Receiver Output vs. Bending Radius

EE-SPZ301Y-01, EE-SPZ401Y-01

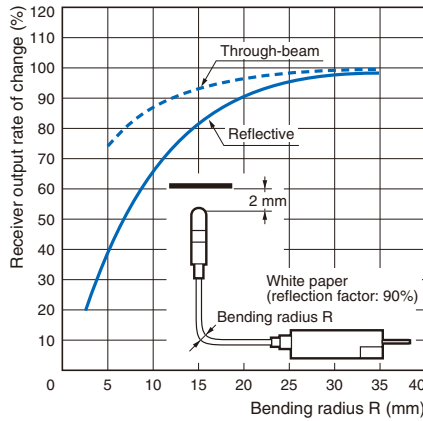

Sensing Distance vs. Object Area Characteristics

EE-SPZ301Y-01, EE-SPZ401Y-01

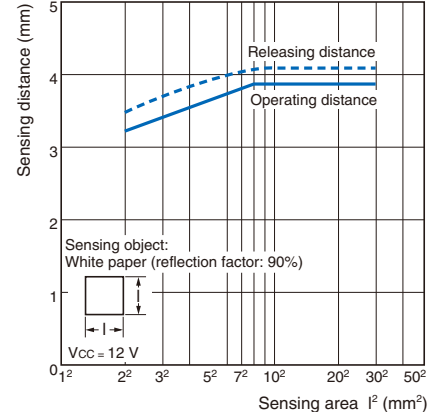

Operating Range Characteristics

EE-SPZ301Y-01, EE-SPZ401Y-01

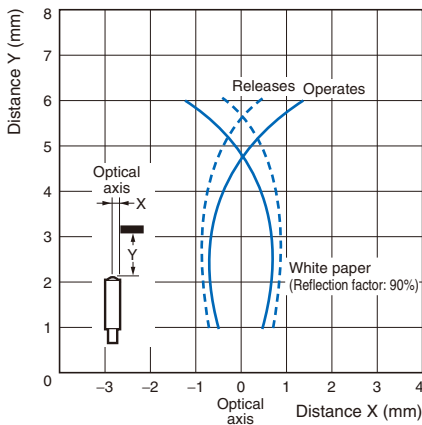

EE-SPZ301Y-01, EE-SPZ401Y-01

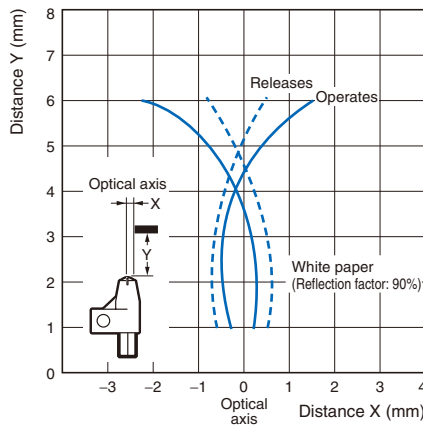

I/O Circuit Diagrams

NPN Output

Model	Output configuration	Timing charts	Output circuit
EE-SPZ401W-02 EE-SPZ401Y-01	Light-ON	<p>Incident Interrupted</p> <p>Light indicator (red) ON OFF</p> <p>Output transistor ON OFF</p> <p>Load 1 (relay) Operates Releases</p> <p>Load 2 H L</p>	<p>* Voltage output (when the sensor is connected to a transistor circuit)</p>
EE-SPZ301W-02 EE-SPZ301Y-01	Dark-ON	<p>Incident Interrupted</p> <p>Light indicator (red) ON OFF</p> <p>Output transistor ON OFF</p> <p>Load 1 (relay) Operates Releases</p> <p>Load 2 H L</p>	

Safety Precautions

Refer to *Warranty and Limitations of Liability*.

⚠ WARNING

This product is not designed or rated for ensuring safety of persons either directly or indirectly. Do not use it for such purposes.



Precautions for Correct Use

Make sure that this product is used within the rated ambient environment conditions.

● Installation

The connection force of the fiber and the Photomicrosensor will decrease when the ambient temperature is high. If high ambient temperatures can be expected, install the fiber with a holder or clip, and do not pull on the fiber.

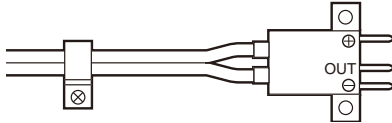

Install the fiber with a holder or clip.

● Wiring

- A fiber that has been once connected cannot be disconnected for reuse.
- Connection is made using a Connector. Do not solder to the pin (lead).
- When extending the cable, use an extension cable with conductors having a total cross-section area of 0.3 mm². The total cable length must be 5 m maximum.
- To use a cable length longer than 5 m, attach a capacitor with a capacitance of approximately 10 μF to the wires as shown below. The distance between the terminal and the capacitor must be within 5 m.
(Use a capacitor with a dielectric strength that is at least twice the Sensor's power supply voltage.)

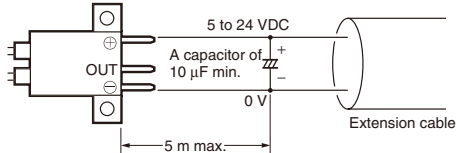

● Adjustment

- The sensing distance of the EE-SPZ301Y-01 and EE-SPZ401Y-01 must be 1 mm maximum or operation will become unstable. Always operate at a distance of minimum 1 mm.
- When the EE-SPZ301Y-01 and EE-SPZ401Y-01 detect a piece of white paper with a reflection factor of 90%, the sensing distance varies from 4 to 10 mm depending on the product. The background object must not be glossy.

(Unit: mm)

Dimensions

Unless otherwise specified, the tolerance class IT16 is used for dimensions in this data sheet.

Sensors

EE-SPZ301W-01
EE-SPZ401W-01

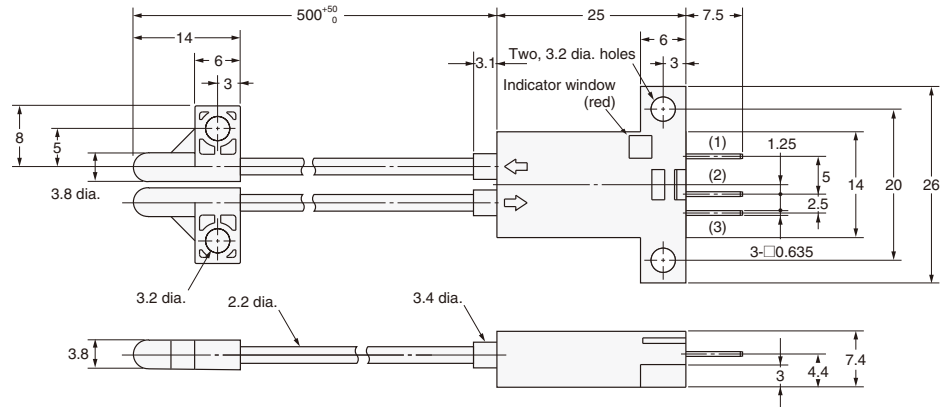
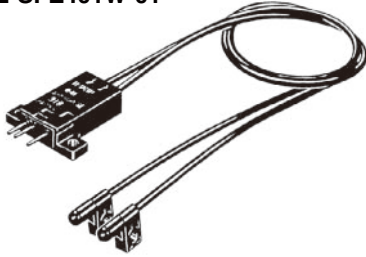

Terminal Arrangement

(1)	⊕	Vcc
(2)	OUT	OUTPUT
(3)	⊖	GND (0 V)

EE-SPZ301W-02
EE-SPZ401W-02

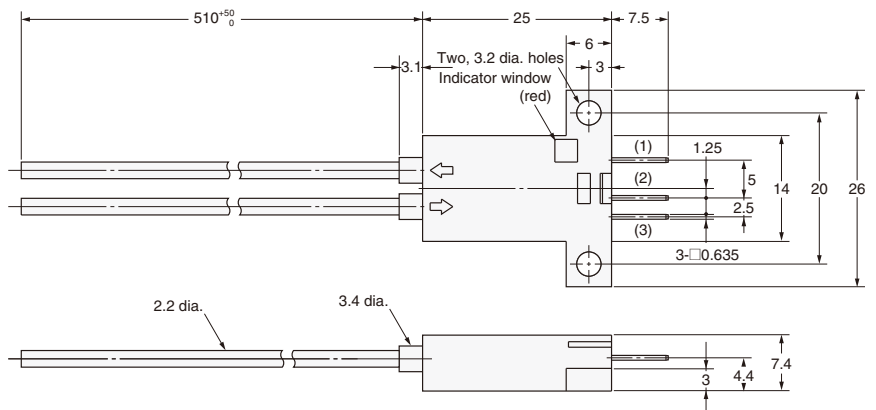
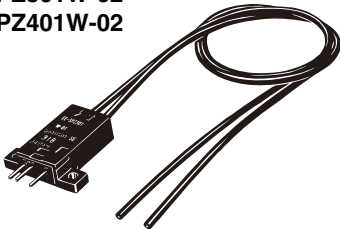

Terminal Arrangement

(1)	⊕	Vcc
(2)	OUT	OUTPUT
(3)	⊖	GND (0 V)

EE-SPZ301Y-01
EE-SPZ401Y-01

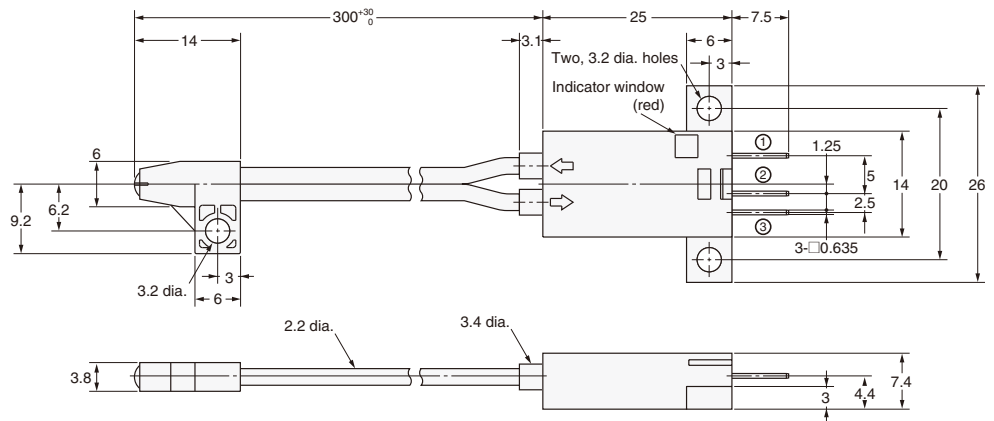

Terminal Arrangement

(1)	⊕	Vcc
(2)	OUT	OUTPUT
(3)	⊖	GND (0 V)

Accessories (Order separately)

Photomicrosensors Technical Guide

General Precautions

Refer to *Safety Precautions* for individual models for specific precautions for each model.

⚠ WARNING

These products cannot be used in safety devices for presses or other safety devices used to protect human life.



This product is designed for use in applications for sensing workpieces and workers that will not affect levels of safety.

Precautions for Safe Use

To ensure safety, observe the following precautions.

●Wiring

Item	Examples
<p>Power Supply</p> <p>Do not apply any voltage exceeding the operating voltage range. Applying any excessive voltage or supplying AC power (100 VAC or higher) to a DC-type sensor may cause the Sensor to explode or burn.</p>	<p>· DC 3-Wire NPN Output Sensors</p>
<p>Load Short-circuit</p> <p>Do not short-circuit the load. Doing so may cause the Sensor to explode or burn.</p>	<p>· DC 3-Wire NPN Output Sensors</p> <p>(Load short-circuit)</p>
<p>Wiring</p> <p>Be sure to wire the Sensor correctly and be careful not to connect the polarities incorrectly, otherwise the Sensor may explode or burn.</p>	<p>· DC 3-Wire NPN Output Sensors (Example) Wrong polarity</p> <p>· DC 3-Wire NPN Output Sensors (Example) Wrong polarity or wrong wiring</p>
<p>Connection with No Load</p> <p>If connected to the power supply without any load, internal elements may explode or burn. Make sure that a proper load is connected to the Sensor.</p>	<p>· DC 3-Wire NPN Output Sensor</p>
<p>AND Connections</p> <p>Do not use AND connections such as in the example shown in the diagram here. Voltage will be applied to the Vcc terminal without the GND terminal of Sensor 2 being securely grounded, and may cause the Sensor to fail. Depending on the model used, in-rush current to Sensor 2 when Sensor 1 is turned ON may cause product failure.</p>	<p>Sensor 1 Sensor 2</p>

Precautions for Correct Use

● Installation

- The Photomicrosensors with Non-modulated Light (models that begin with EE-SX or EE-SY) are built into the device being used and are, therefore, not equipped to deal with interference from an external light source. When using a Photomicrosensor with Non-modulated Light in an area exposed to an incandescent light or other external light interference, install so as to minimize the effects of external light sources.
- Mount the Photomicrosensors securely on a flat surface
- Mount the Photomicrosensors with M3 screws, using a spring washer to ensure the screws will not become loose. Use a tightening force of 0.59 N·m max.

Note: Be sure to read the precautions for the model being used before tightening the screws.

- Install so that nothing can collide with the sensing section of the Photomicrosensor. Damage to the sensing surface will cause inferior performance.
- Before using the Photomicrosensor, check to be sure that it has not become loose due to vibration or shock.

● Wiring

Surge

- If there is surge in the power supply line, try connecting a capacitor (with a capacitance of 0.1 to 1 μF) or a Zener diode (Z_D in the diagram below, with a rated voltage of 30 to 35 V). Use the Sensor only after confirming that the surge has been removed.

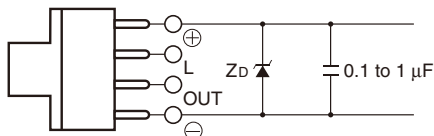

Z_D: Zener diode

- When driving a small inductive load, such as a relay, wire as shown below. (Be sure to connect a diode to absorb the reverse voltage.)

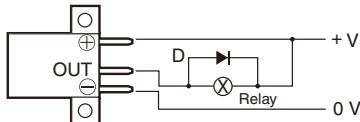

- Separate the wiring for the Photomicrosensor from high-voltage lines or power lines. If the wiring is routed in the same conduit or duct as such lines, the Photomicrosensor may malfunction or may be damaged by inductive interference.
- Make sure that the connectors (either dedicated or commercially available) are securely locked.

Voltage Output

- A Sensor with an open-collector output can be connected to a counter with a voltage input by connecting a resistor between the power source and output. Select a resistor with reference to the following example. The resistance of the resistor is generally 4.7 kΩ and its wattage is 1/2 W for a supply voltage of 24 V and 1/4 W for 12 V.

<Example>

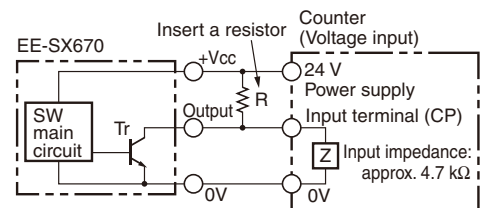

If resistance R = 4.7 kΩ for the EE-SX670, the input voltage at the high level is as follows:

$$\text{Input voltage } V_H = \frac{Z}{R+Z} V_{CC} = \frac{4.7k}{4.7k + 4.7k} \times 24V = 12V$$

And the input voltage and load current at the low level are as follows:

Input voltage $V_L \leq 0.4 V$ (Residual voltage for 40-mA load current)

$$\text{Load current } I_C = \frac{V_{CC}}{R} = \frac{24V}{4.7k} = 5.1mA \leq 40mA$$

Note: Refer to the ratings of the Sensor for the residual voltage of the load current.

Handling Methods when Wiring

- Do not apply stress (external force) to the terminals as shown in the figure below. Stress may damage the terminals.



Photomicrosensors Technical Guide

● Design Considerations

Precautions for Photomicrosensors with Modulated Light

When using Photomicrosensors with Modulated Light (models that begin with EE-SP), the design must take into account the effects of power source and cable length. Photomicrosensors with Modulated Light are more easily affected than Photomicrosensors with Non-modulated Light (models that begin with EE-SX or EE-SY).

● Photomicrosensors with Modulated Light that are easily affected:

EE-SPX301/401, EE-SPY30□/40□,
E-SPZ301□/401□, EE-SPY31□/41□,
EE-SPX303/403, EE-SPW311/411,
EE-SPX74□/84□, EE-SPX□□□-W

● Photomicrosensors with Modulated Light that are not easily affected:

EE-SPX613, EE-SPY801/802

Reasons for Interference from Power and Cable Length on Photomicrosensors with Modulated Light

As explained in Principles, an LED emitter is pulse-lighted to produce modulated light. A large current momentarily flows to the Photomicrosensor in sync with this pulse timing. This causes a pulsating consumption current.

A photoelectric sensor incorporates a capacitor with sufficient capacity, and is virtually unaffected by the pulse of the consumption current. With a small Photomicrosensor, however, it is difficult to have a capacitor with a sufficient capacity. Accordingly, when the cable length is long or depending on the type of power source, it may become impossible to keep up with the pulse of the consumption current and operation may become unstable.

Countermeasures

<Adding a Capacitor>

Attach a capacitor of 10 μF min. (e.g., a film capacitor) to the wires as close as possible to the Sensor. (Use a capacitor with a dielectric strength that is at least twice the Sensor's power supply voltage. Do not use tantalum capacitors. A short-circuit may cause the capacitor to ignite due to the large current flow.)

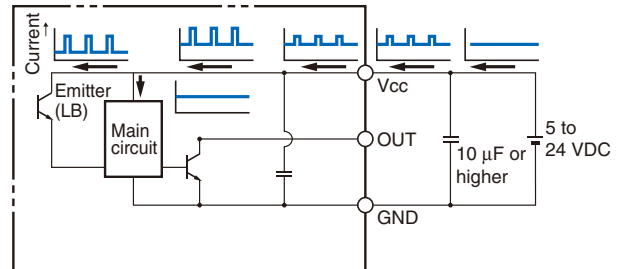

<Cable Length>

- Design the configuration so that the maximum total cable length for the Photomicrosensor with Modulated Light is 2 m.
- When using a cable longer than 2 m, attach a capacitor (e.g., an aluminum electrolytic capacitor) with a capacity of approximately 10 μF to the wires as shown below. The distance between the terminal and the capacitor must be within 2 m. Make sure that the total cable length is no longer than 5 m. To use a cable length longer than 5 m, use a PLC or other means to read the sensor output and then transmit the signals using a PLC's communications.
- Regardless of whether a Photomicrosensor with Modulated Light or a Photomicrosensor with Non-modulated Light is used, make sure that the total combined length of the Photomicrosensor cable and the connecting cable is less than 10 m.
- Although cables are capable of being extended longer than 5 m, performance is likely to be affected by noise interference from adjacent cables and other devices. Voltage drops due to the resistance of the cable material itself will also influence performance. Therefore, factors, such as the difference in voltage between the end of the cable and the sensor and noise levels, must be given full consideration.

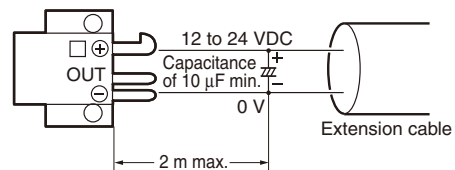

<Countermeasures for Switching Power Supplies>

- Take either of the following countermeasures as required if connecting a Photomicrosensor with Modulated Light to a switching power supply.
- (1) Attach a capacitor of 10 μF min. to the wires as close as possible to the Photomicrosensor. (Use a capacitor with a dielectric strength that is at least twice the Photomicrosensor's power supply voltage. Do not use tantalum capacitors. A short-circuit may cause the capacitor to ignite due to the large current flow.)

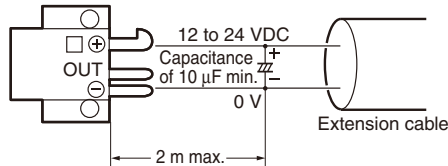

- (2) Connect to the 0-V line of the power source or connect to the power source via a capacitor of approximately 0.47 μF to reduce the impedance of the mounting base to prevent inductive noise from entering the mounting base.

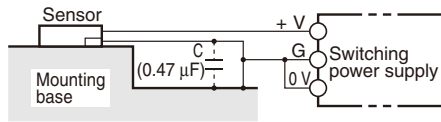

- (3) Connect the noise filter terminal (neutral terminal to ACG) of the switching power supply to the case (FG) and 0-V terminal of the power supply.

The line connected as mentioned above should be grounded or connected to the mounting base to ensure stable operation. (Recommended by power supply manufacturers.)

<Countermeasures to Handle Inductive Noise>

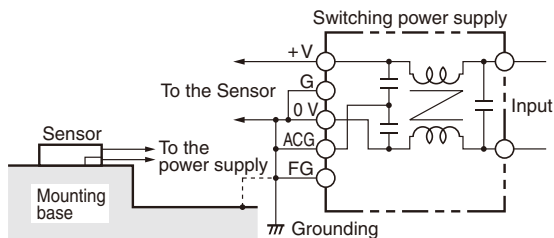

- (4) Insert a plastic insulator of approximately 10 mm between the Sensor and the mounting base.

<Effects of Inductive Noise>

- When there is inductive noise in the Sensor mounting frame (metal), the output of the Sensor may be affected. In this case, ensure that there is no electrical potential difference between the Sensor 0-V terminal and the Sensor mounting frame, or put a 0.47- μF capacitor between the 0-V terminal and the frame.

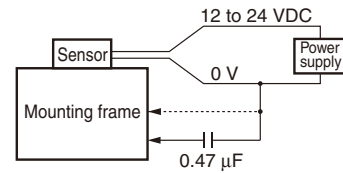

Precautions for Reflective Photomicrosensors

<Sensing Distance>

- The Reflective Photomicrosensor model is based on sensing a sheet of white paper with a reflection factor of 90%. The sensing distance varies with the other conditions of the objects being detected.

<Typical Example> EE-SPY30/40 Series

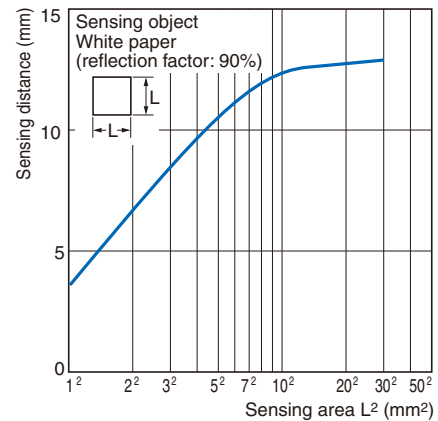

<Background Objects>

- Use the Sensor only after carefully studying the possibility of light entering the Sensor due to light being reflected off background objects.

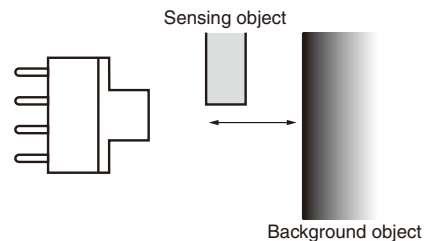

Decrease reflection from the background object, e.g., by providing a sufficient distance to the background or by using a black sponge as the background.

Photomicrosensors Technical Guide

PLC Connections

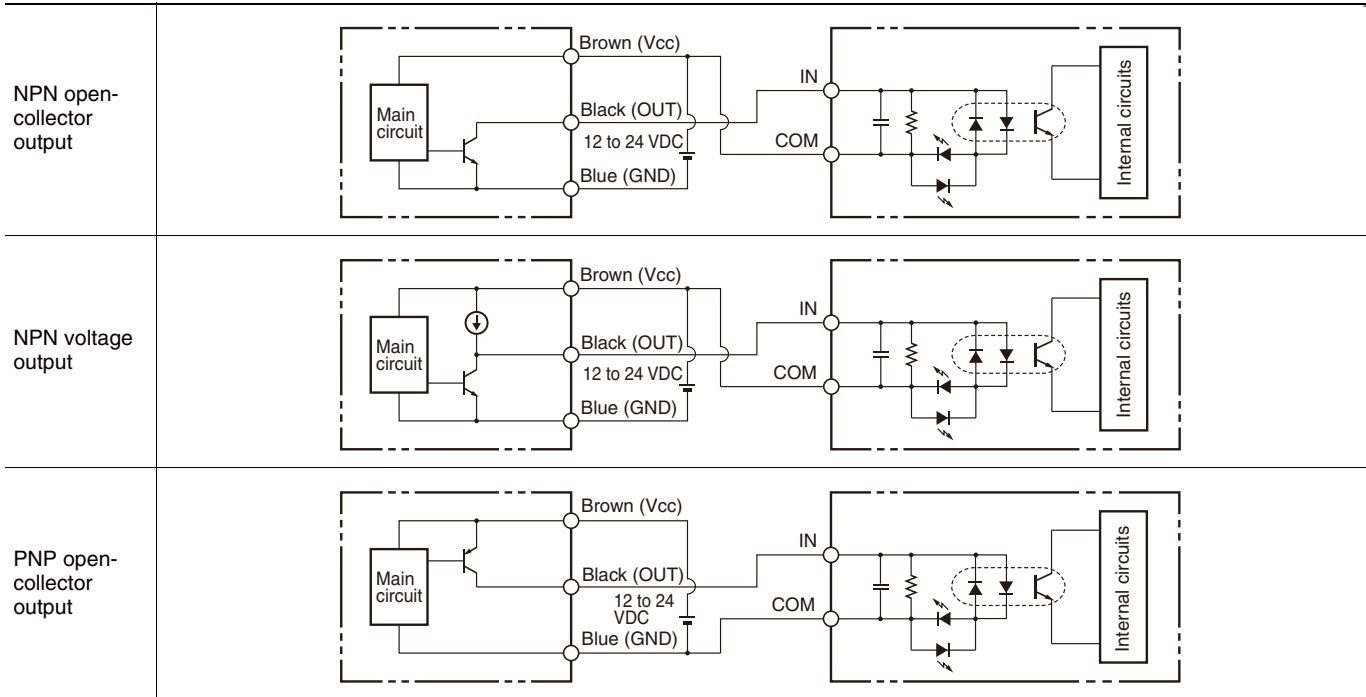

Relay Connections

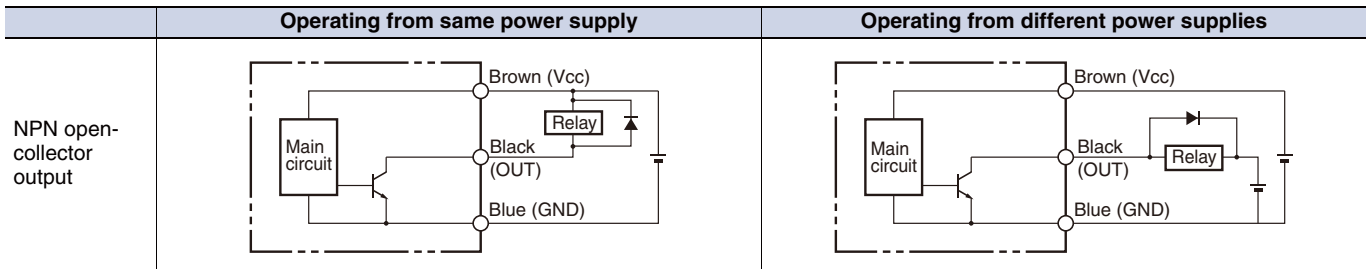

Counter Connections

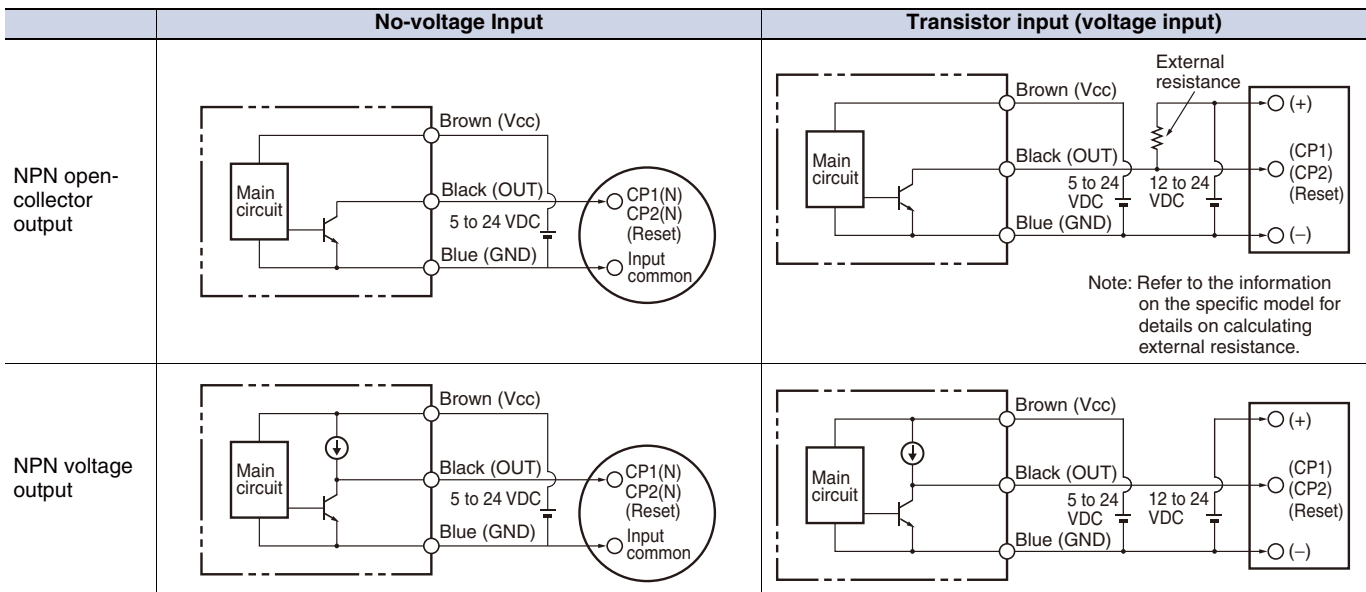

● Other Precautions

- Do not disconnect the Connector from the Sensor when power is supplied to the Sensor. Doing so may damage the Sensor.
- Avoid installing the Sensor in the following locations to prevent malfunction or product failure:
 - (1) Location exposed to high concentrations of dust, oil mist, etc.
 - (2) Locations exposed to corrosive gases
 - (3) Locations exposed directly or indirectly to water, oil, or chemical spray
 - (4) Outdoors or locations exposed to intensive light, such as direct sunlight
- Be sure to use the Sensor under the rated ambient temperature.
- The Sensor may be dissolved by exposure to organic solvents, acids, alkali, aromatic hydrocarbons or chloride resin hydrocarbons, causing deterioration in characteristics. Do not expose the Sensor to such chemicals.

Read and Understand This Catalog

Please read and understand this catalog before purchasing the products. Please consult your OMRON representative if you have any questions or comments.

Warranty and Limitations of Liability

WARRANTY

OMRON's exclusive warranty is that the products are free from defects in materials and workmanship for a period of one year (or other period if specified) from date of sale by OMRON.

OMRON MAKES NO WARRANTY OR REPRESENTATION, EXPRESS OR IMPLIED, REGARDING NON-INFRINGEMENT, MERCHANTABILITY, OR FITNESS FOR PARTICULAR PURPOSE OF THE PRODUCTS. ANY BUYER OR USER ACKNOWLEDGES THAT THE BUYER OR USER ALONE HAS DETERMINED THAT THE PRODUCTS WILL SUITABLY MEET THE REQUIREMENTS OF THEIR INTENDED USE. OMRON DISCLAIMS ALL OTHER WARRANTIES, EXPRESS OR IMPLIED.

LIMITATIONS OF LIABILITY

OMRON SHALL NOT BE RESPONSIBLE FOR SPECIAL, INDIRECT, OR CONSEQUENTIAL DAMAGES, LOSS OF PROFITS, OR COMMERCIAL LOSS IN ANY WAY CONNECTED WITH THE PRODUCTS, WHETHER SUCH CLAIM IS BASED ON CONTRACT, WARRANTY, NEGLIGENCE, OR STRICT LIABILITY.

In no event shall responsibility of OMRON for any act exceed the individual price of the product on which liability is asserted.

IN NO EVENT SHALL OMRON BE RESPONSIBLE FOR WARRANTY, REPAIR, OR OTHER CLAIMS REGARDING THE PRODUCTS UNLESS OMRON'S ANALYSIS CONFIRMS THAT THE PRODUCTS WERE PROPERLY HANDLED, STORED, INSTALLED, AND MAINTAINED AND NOT SUBJECT TO CONTAMINATION, ABUSE, MISUSE, OR INAPPROPRIATE MODIFICATION OR REPAIR.

Application Considerations

SUITABILITY FOR USE

OMRON shall not be responsible for conformity with any standards, codes, or regulations that apply to the combination of products in the customer's application or use of the product.

At the customer's request, OMRON will provide applicable third party certification documents identifying ratings and limitations of use that apply to the products. This information by itself is not sufficient for a complete determination of the suitability of the products in combination with the end product, machine, system, or other application or use.

The following are some examples of applications for which particular attention must be given. This is not intended to be an exhaustive list of all possible uses of the products, nor is it intended to imply that the uses listed may be suitable for the products:

- Outdoor use, uses involving potential chemical contamination or electrical interference, or conditions or uses not described in this catalog.
- Nuclear energy control systems, combustion systems, railroad systems, aviation systems, medical equipment, amusement machines, vehicles, safety equipment, and installations subject to separate industry or government regulations.
- Systems, machines, and equipment that could present a risk to life or property.

Please know and observe all prohibitions of use applicable to the products.

NEVER USE THE PRODUCTS FOR AN APPLICATION INVOLVING SERIOUS RISK TO LIFE OR PROPERTY WITHOUT ENSURING THAT THE SYSTEM AS A WHOLE HAS BEEN DESIGNED TO ADDRESS THE RISKS, AND THAT THE OMRON PRODUCT IS PROPERLY RATED AND INSTALLED FOR THE INTENDED USE WITHIN THE OVERALL EQUIPMENT OR SYSTEM.

Disclaimers

CHANGE IN SPECIFICATIONS

Product specifications and accessories may be changed at any time based on improvements and other reasons.

It is our practice to change model numbers when published ratings or features are changed, or when significant construction changes are made. However, some specifications of the product may be changed without any notice. When in doubt, special model numbers may be assigned to fix or establish key specifications for your application on your request. Please consult with your OMRON representative at any time to confirm actual specifications of purchased product.

DIMENSIONS AND WEIGHTS

Dimensions and weights are nominal and are not to be used for manufacturing purposes, even when tolerances are shown.

ERRORS AND OMISSIONS

The information in this catalog has been carefully checked and is believed to be accurate; however, no responsibility is assumed for clerical, typographical, or proofreading errors, or omissions.

PERFORMANCE DATA

Performance data given in this catalog is provided as a guide for the user in determining suitability and does not constitute a warranty. It may represent the result of OMRON's test conditions, and the users must correlate it to actual application requirements. Actual performance is subject to the OMRON Warranty and Limitations of Liability.

PROGRAMMABLE PRODUCTS

OMRON shall not be responsible for the user's programming of a programmable product, or any consequence thereof.

COPYRIGHT AND COPY PERMISSION

This catalog shall not be copied for sales or promotions without permission.

This catalog is protected by copyright and is intended solely for use in conjunction with the product. Please notify us before copying or reproducing this catalog in any manner, for any other purpose. If copying or transmitting this catalog to another, please copy or transmit it in its entirety.