

FEATURES

- **3.3V Supply Voltage**
- **20Mbps Maximum Data Rate**
- **No Damage or Latchup Up to ±15kV HBM**
- **High Input Impedance Supports 256 Nodes (C, I-Grade)**
- **Operation Up to 125°C (H-Grade)**
- **Guaranteed Failsafe Receiver Operation Over the Entire Common Mode Range**
- **Current Limited Drivers and Thermal Shutdown**
- **Delayed Micropower Shutdown: 5µA Maximum (C, I-Grade)**
- **Power Up/Down Glitch-Free Driver Outputs**
- **Low Operating Current: 370µA Typical in Receive Mode**
- **Compatible with TIA/EIA-485-A Specifications**
- **Available in 8-Pin and 10-Pin 3mm × 3mm DFN, 8-Pin and 10-Pin MSOP, and 8-Pin and 14-Pin SO Packages**

APPLICATIONS

- Low Power RS485/RS422 Transceiver
- Level Translator
- Backplane Transceiver

DESCRIPTION

The LTC[®]2850, LTC2851, and LTC2852 are low power, 20Mbps RS485/RS422 transceivers operating on 3.3V supplies. The receiver has a one-eighth unit load supporting up to 256 nodes per bus (C, I-Grade), and a failsafe feature that guarantees a high output state under conditions of floating or shorted inputs.

The driver maintains a high output impedance over the entire common mode range when disabled or when the supply is removed. Excessive power dissipation caused by bus contention or a fault is prevented by current limiting all outputs and by thermal shutdown.

Enhanced ESD protection allows these parts to withstand up to ±15kV (human body model) on the transceiver interface pins without latchup or damage.

PART NUMBER	DUPLEX	PACKAGE
LTC2850	Half	SO-8, MSOP-8, DFN-8
LTC2851	Full	SO-8, MSOP-8, DFN-8
LTC2852	Full	SO-14, MSOP-10, DFN-10

LT, LT, LTC and LTM are registered trademarks of Linear Technology Corporation. All other trademarks are the property of their respective owners.

TYPICAL APPLICATION

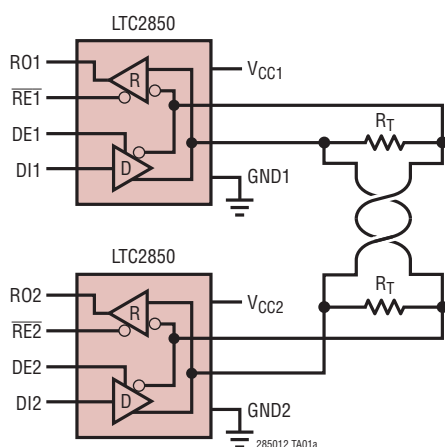

LTC2850 at 20Mbps Into 54Ω

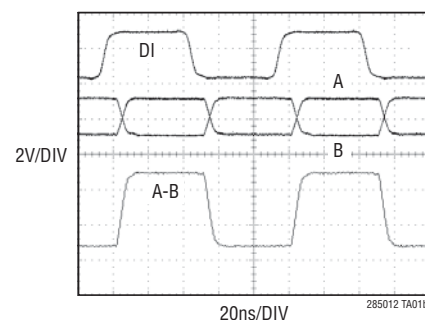

LTC2850/LTC2851/LTC2852

ABSOLUTE MAXIMUM RATINGS

(Note 1)

Supply Voltage (V_{CC}) -0.3V to 7V
 Logic Input Voltages (\overline{RE} , DE, DI) -0.3V to 7V
 Interface I/O:
 A, B, Y, Z ($V_{CC} - 15V$) to 15V
 Receiver Output Voltage (RO) -0.3V to ($V_{CC} + 0.3V$)

Operating Temperature (Note 4)

LTC285xC 0°C to 70°C
 LTC285xI -40°C to 85°C
 LTC285xH -40°C to 125°C
 Storage Temperature Range -65°C to 150°C
 Lead Temperature (Soldering, 10 sec)
 MSOP 300°C

PIN CONFIGURATION

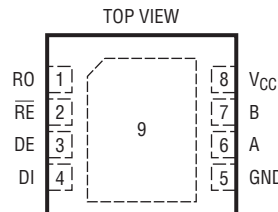
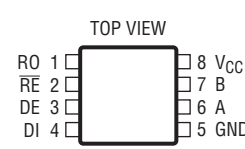
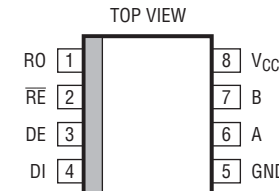
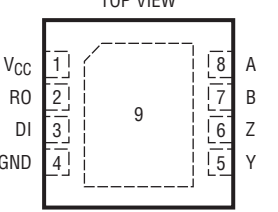
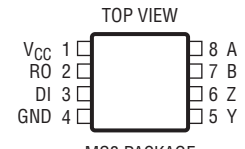
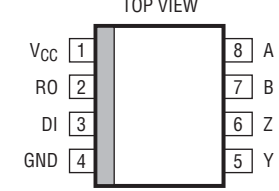
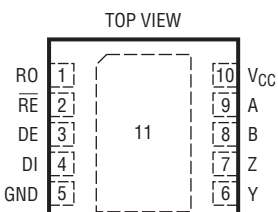
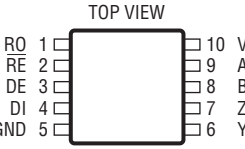
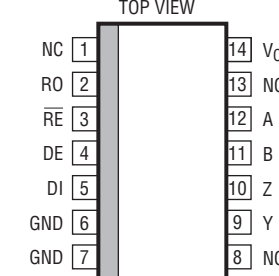
<p>LTC2850</p>  <p>DD PACKAGE 8-LEAD (3mm × 3mm) PLASTIC DFN $T_{JMAX} = 150^{\circ}C$, $\theta_{JA} = 43^{\circ}C/W$, $\theta_{JC} = 3^{\circ}C/W$ EXPOSED PAD (PIN 9) IS GND, MUST BE SOLDERED TO PCB</p>	 <p>MS8 PACKAGE 8-LEAD PLASTIC MSOP $T_{JMAX} = 150^{\circ}C$, $\theta_{JA} = 200^{\circ}C/W$, $\theta_{JC} = 40^{\circ}C/W$</p>	 <p>S8 PACKAGE 8-LEAD PLASTIC SO $T_{JMAX} = 150^{\circ}C$, $\theta_{JA} = 150^{\circ}C/W$, $\theta_{JC} = 39^{\circ}C/W$</p>
<p>LTC2851</p>  <p>DD PACKAGE 8-LEAD (3mm × 3mm) PLASTIC DFN $T_{JMAX} = 150^{\circ}C$, $\theta_{JA} = 43^{\circ}C/W$, $\theta_{JC} = 3^{\circ}C/W$ EXPOSED PAD (PIN 9) IS GND, MUST BE SOLDERED TO PCB</p>	 <p>MS8 PACKAGE 8-LEAD PLASTIC MSOP $T_{JMAX} = 150^{\circ}C$, $\theta_{JA} = 200^{\circ}C/W$, $\theta_{JC} = 40^{\circ}C/W$</p>	 <p>S8 PACKAGE 8-LEAD PLASTIC SO $T_{JMAX} = 150^{\circ}C$, $\theta_{JA} = 150^{\circ}C/W$, $\theta_{JC} = 39^{\circ}C/W$</p>
<p>LTC2852</p>  <p>DD PACKAGE 10-LEAD (3mm × 3mm) PLASTIC DFN $T_{JMAX} = 150^{\circ}C$, $\theta_{JA} = 43^{\circ}C/W$, $\theta_{JC} = 3^{\circ}C/W$ EXPOSED PAD (PIN 11) IS GND, MUST BE SOLDERED TO PCB</p>	 <p>MS PACKAGE 10-LEAD PLASTIC MSOP $T_{JMAX} = 150^{\circ}C$, $\theta_{JA} = 120^{\circ}C/W$, $\theta_{JC} = 45^{\circ}C/W$</p>	 <p>S PACKAGE 14-LEAD PLASTIC SO $T_{JMAX} = 150^{\circ}C$, $\theta_{JA} = 88^{\circ}C/W$, $\theta_{JC} = 37^{\circ}C/W$</p>

285012fc

ORDER INFORMATION

LTC2850 C DD #TR PBF

LEAD FREE DESIGNATOR

PBF = Lead Free

TAPE AND REEL

TR = Tape and Reel

PACKAGE TYPE

DD = 8-Lead Plastic DFN

DD = 10-Lead Plastic DFN

MS8 = 8-Lead Plastic MSOP

MS = 10-Lead Plastic MSOP

S8 = 8-Lead Plastic SO

S = 14-Lead Plastic SO

TEMPERATURE GRADE

C = Commercial Temperature Range (0°C to 70°C)

I = Industrial Temperature Range (-40°C to 85°C)

H = Automotive Temperature Range (-40°C to 125°C)

PRODUCT PART NUMBER

LTC2850 = Half Duplex, with Enables

LTC2851 = Full Duplex, No Enables

LTC2852 = Full Duplex, with Enables

www.DataSheet4U.com

Consult LTC Marketing for information on non-standard lead based finish parts.

For more information on lead free part marking, go to: <http://www.linear.com/leadfree/>

For more information on tape and reel specifications, go to: <http://www.linear.com/tapeandreeel/>

PRODUCT SELECTION GUIDE

PART NUMBER	PART MARKING	DUPLEX	LOW POWER SHUTDOWN MODE	PACKAGE
LTC2850	2850/I/H, LTCQD, LCQC	Half	Yes	SO-8, MSOP-8, DFN-8
LTC2851	2851/I/H, LTCWF, LCWD	Full	No	SO-8, MSOP-8, DFN-8
LTC2852	2852CS/IS/HS, LTCRX, LCRY	Full	Yes	SO-14, MSOP-10, DFN-10

LTC2850/LTC2851/LTC2852

ELECTRICAL CHARACTERISTICS

The ● denotes the specifications which apply over the full operating temperature range, otherwise specifications are at $T_A = 25^\circ\text{C}$. $V_{CC} = 3.3\text{V}$ unless otherwise noted. (Note 2)

SYMBOL	PARAMETER	CONDITIONS	MIN	TYP	MAX	UNITS
Driver						
$ V_{OD} $	Differential Driver Output Voltage	$R = \infty, V_{CC} = 3\text{V}$ (Figure 1) $R = 27\Omega, V_{CC} = 3\text{V}$ (Figure 1) $R = 50\Omega, V_{CC} = 3.13\text{V}$ (Figure 1)	● ● ●	1.5 2	V_{CC} V_{CC} V_{CC}	V V V
$\Delta V_{OD} $	Difference in Magnitude of Driver Differential Output Voltage for Complementary Output States	$R = 27\Omega$ or 50Ω (Figure 1)	●		0.2	V
V_{OC}	Driver Common Mode Output Voltage	$R = 27\Omega$ or 50Ω (Figure 1)	●		3	V
$\Delta V_{OC} $	Difference in Magnitude of Driver Common Mode Output Voltage for Complementary Output States	$R = 27\Omega$ or 50Ω (Figure 1)	●		0.2	V
I_{OZD}	Driver Three-State (High Impedance) Output Current on Y and Z	$DE = 0\text{V}$, (Y or Z) = -7V , 12V (LTC2852)	●		± 10	μA
I_{OSD}	Maximum Driver Short-Circuit Current	$-7\text{V} \leq (\text{Y or Z}) \leq 12\text{V}$ (Figure 2)	●	-250	± 180 ± 250 300	mA mA
Receiver						
I_{IN}	Receiver Input Current (A, B)	$DE = TE = 0\text{V}$, $V_{CC} = 0\text{V}$ or 3.3V , $V_{IN} = 12\text{V}$ (Figure 3) (C, I-Grade) $DE = TE = 0\text{V}$, $V_{CC} = 0\text{V}$ or 3.3V , $V_{IN} = -7\text{V}$, (Figure 3) (C, I-Grade) $DE = TE = 0\text{V}$, $V_{CC} = 0\text{V}$ or 3.3V , $V_{IN} = 12\text{V}$ (Figure 3) (H-Grade) $DE = TE = 0\text{V}$, $V_{CC} = 0\text{V}$ or 3.3V , $V_{IN} = -7\text{V}$, (Figure 3) (H-Grade)	● ● ● ●	-100	125 250	μA μA μA μA
R_{IN}	Receiver Input Resistance	$\overline{RE} = V_{CC}$ or 0V , $DE = TE = 0\text{V}$, $V_{IN} = -7\text{V}$, -3V , 3V , 7V , 12V (Figure 3) (C, I-Grade) $\overline{RE} = V_{CC}$ or 0V , $DE = TE = 0\text{V}$, $V_{IN} = -7\text{V}$, -3V , 3V , 7V , 12V (Figure 3) (H-Grade)	● ●	96 48	125 125	$\text{k}\Omega$ $\text{k}\Omega$
V_{TH}	Receiver Differential Input Threshold Voltage	$-7\text{V} \leq B \leq 12\text{V}$	●		± 0.2	V
ΔV_{TH}	Receiver Input Hysteresis	$B = 0\text{V}$		25		mV
V_{OH}	Receiver Output High Voltage	$I(\text{RO}) = -4\text{mA}$, $A-B = 200\text{mV}$, $V_{CC} = 3\text{V}$	●	2.4		V
V_{OL}	Receiver Output Low Voltage	$I(\text{RO}) = 4\text{mA}$, $A-B = -200\text{mV}$, $V_{CC} = 3\text{V}$	●		0.4	V
I_{OZR}	Receiver Three-State (High Impedance) Output Current on RO	$\overline{RE} = V_{CC}$, $0\text{V} \leq \text{RO} \leq V_{CC}$ (LTC2850, LTC2852)	●		± 1	μA
I_{OSR}	Receiver Short-Circuit Current	$0\text{V} \leq \text{RO} \leq V_{CC}$	●		± 85	mA
Logic						
V_{IH}	Logic Input High Voltage	$V_{CC} = 3.6\text{V}$	●	2		V
V_{IL}	Logic Input Low Voltage	$V_{CC} = 3\text{V}$	●		0.8	V
I_{INL}	Logic Input Current		●	0	± 10	μA

ELECTRICAL CHARACTERISTICS

The ● denotes the specifications which apply over the full operating temperature range, otherwise specifications are at $T_A = 25^\circ\text{C}$. $V_{CC} = 3.3\text{V}$ unless otherwise noted. (Note 2)

SYMBOL	PARAMETER	CONDITIONS	MIN	TYP	MAX	UNITS
Supplies						
I_{CCS}	Supply Current in Shutdown Mode	DE = 0V, $\overline{RE} = V_{CC}$, LTC2850, LTC2852 (C and I-Grade)	●	0	5	μA
		LTC2850, LTC2852 (H-Grade)	●	0	15	μA
I_{CCR}	Supply Current in Receive Mode	DE = 0V, $\overline{RE} = 0\text{V}$ (LTC2850, LTC2852)	●	370	900	μA
I_{CCT}	Supply Current in Transmit Mode	No Load, DE = V_{CC} , $\overline{RE} = V_{CC}$ (LTC2850, LTC2852)	●	450	1000	μA
I_{CCTR}	Supply Current with Both Driver and Receiver Enabled	No Load, DE = V_{CC} , $\overline{RE} = 0\text{V}$	●	450	1000	μA

www.DataSheet4U.com

SWITCHING CHARACTERISTICS

The ● denotes the specifications which apply over the full operating temperature range, otherwise specifications are at $T_A = 25^\circ\text{C}$. $V_{CC} = 3.3\text{V}$, unless otherwise noted. (Note 2)

SYMBOL	PARAMETER	CONDITIONS	MIN	TYP	MAX	UNITS
Driver						
f_{MAX}	Maximum Data Rate	(Note 3)	●	20		Mbps
t_{PLHD} , t_{PHLD}	Driver Input to Output	$R_{DIFF} = 54\Omega$, $C_L = 100\text{pF}$ (Figure 4)	●	10	50	ns
Δt_{PD}	Driver Input to Output Difference $ t_{PLHD} - t_{PHLD} $	$R_{DIFF} = 54\Omega$, $C_L = 100\text{pF}$ (Figure 4)	●	1	6	ns
t_{SKEWD}	Driver Output Y to Output Z	$R_{DIFF} = 54\Omega$, $C_L = 100\text{pF}$ (Figure 4)	●	1	± 6	ns
t_{RD} , t_{FD}	Driver Rise or Fall Time	$R_{DIFF} = 54\Omega$, $C_L = 100\text{pF}$ (Figure 4)	●	4	12.5	ns
t_{ZLD} , t_{ZHD} , t_{LZD} , t_{HZD}	Driver Enable or Disable Time	$R_L = 500\Omega$, $C_L = 50\text{pF}$, $\overline{RE} = 0\text{V}$ (Figure 5) (LTC2850, LTC2852)	●		70	ns
t_{ZHSD} , t_{ZLSD}	Driver Enable from Shutdown	$R_L = 500\Omega$, $C_L = 50\text{pF}$, $\overline{RE} = V_{CC}$ (Figure 5) (LTC2850, LTC2852)	●		8	μs
t_{SHDN}	Time to Shutdown	$R_L = 500\Omega$, $C_L = 50\text{pF}$, (DE = \downarrow , $\overline{RE} = V_{CC}$) or (DE = 0V, $\overline{RE} = \uparrow$) (Figure 5) (LTC2850, LTC2852)	●		100	ns
Receiver						
t_{PLHR} , t_{PHLR}	Receiver Input to Output	$C_L = 15\text{pF}$, $V_{CM} = 1.5\text{V}$, $ V_{AB} = 1.5\text{V}$, t_R and $t_F < 4\text{ns}$ (Figure 6)	●	50	70	ns
t_{SKEWR}	Differential Receiver Skew $ t_{PLHR} - t_{PHLR} $	$C_L = 15\text{pF}$ (Figure 6)	●	1	6	ns
t_{RR} , t_{FR}	Receiver Output Rise or Fall Time	$C_L = 15\text{pF}$ (Figure 6)	●	3	12.5	ns
t_{ZLR} , t_{ZHR} , t_{LZR} , t_{HZR}	Receiver Enable/Disable	$R_L = 1\text{k}$, $C_L = 15\text{pF}$, DE = V_{CC} (Figure 7) (LTC2850, LTC2852)	●		50	ns
t_{ZHRSR} , t_{ZLSR}	Receiver Enable from Shutdown	$R_L = 1\text{k}$, $C_L = 15\text{pF}$, DE = 0V (Figure 7) (LTC2850, LTC2852)	●		8	μs

Note 1: Stresses beyond those listed under Absolute Maximum Ratings may cause permanent damage to the device. Exposure to any Absolute Maximum Rating condition for extended periods may affect device reliability and lifetime. High temperatures degrade operating lifetimes. Operating lifetime is derated at temperatures greater than 105°C .

Note 2: All currents into device pins are positive; all currents out of device pins are negative. All voltages are referenced to device ground unless otherwise specified.

Note 3: Maximum data rate is guaranteed by other measured parameters and is not tested directly.

Note 4: This IC includes overtemperature protection that is intended to protect the device during momentary overload conditions. Overtemperature protection activates at a junction temperature exceeding 150°C . Continuous operation above the specified maximum operating junction temperature may result in device degradation or failure.

285012fc

TEST CIRCUITS

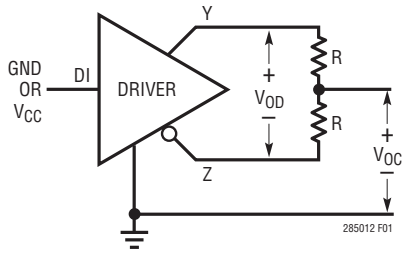

Figure 1. Driver DC Characteristics

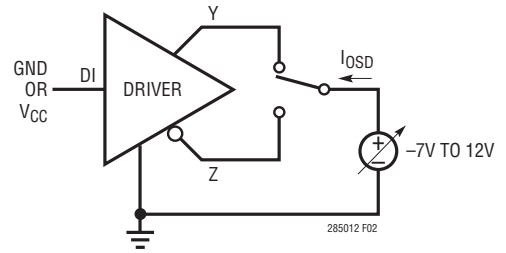

Figure 2. Driver Output Short-Circuit Current

www.DataSheet4U.com

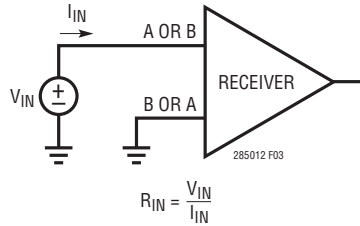

Figure 3. Receiver Input Current and Input Resistance

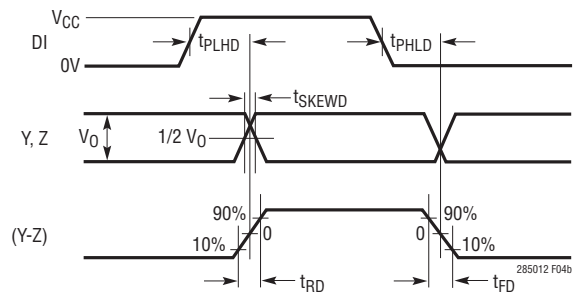
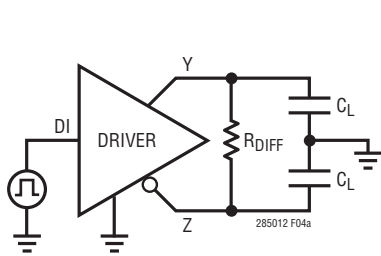

Figure 4. Driver Timing Measurement

TEST CIRCUITS

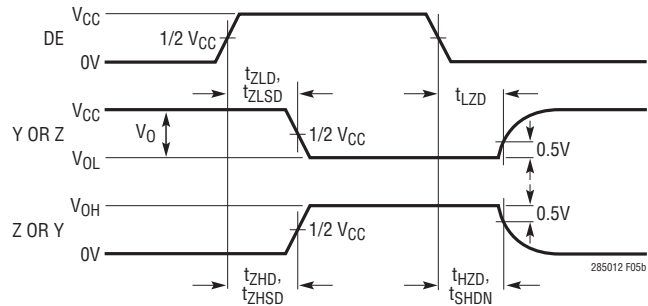
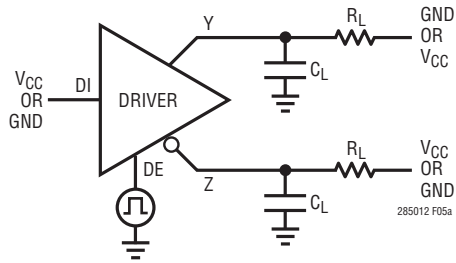

Figure 5. Driver Enable and Disable Timing Measurements

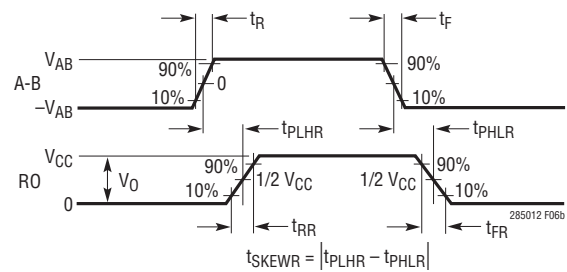
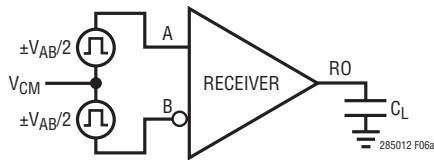

Figure 6. Receiver Propagation Delay Measurements

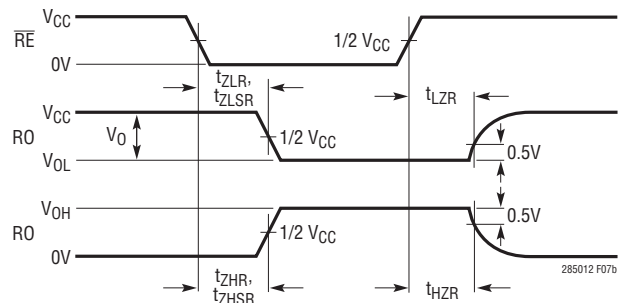
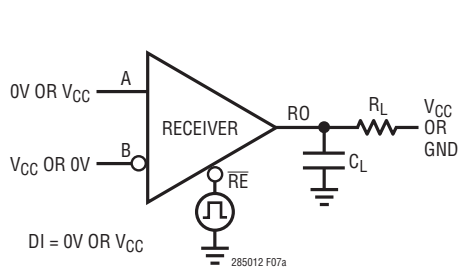
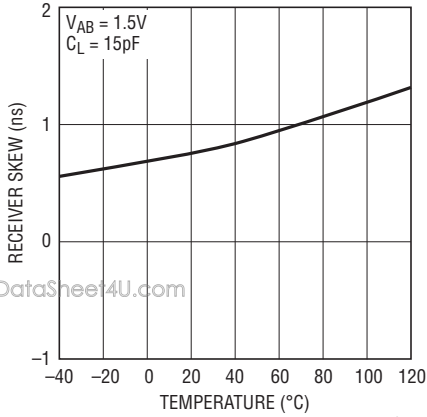

Figure 7. Receiver Enable/Disable Time Measurements

TYPICAL PERFORMANCE CHARACTERISTICS $T_A = 25^\circ\text{C}$. $V_{CC} = 3.3\text{V}$ unless otherwise noted.

Receiver Skew vs Temperature



285012 G01

Driver Skew vs Temperature

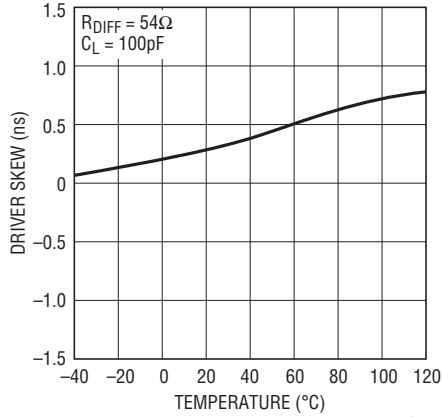

285012 G02

Driver Propagation Delay vs Temperature

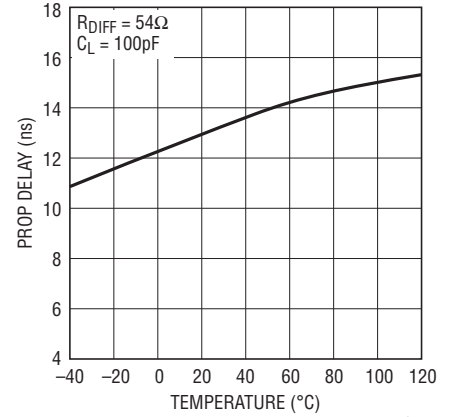

285012 G03

Driver Output Short-Circuit Current vs Temperature

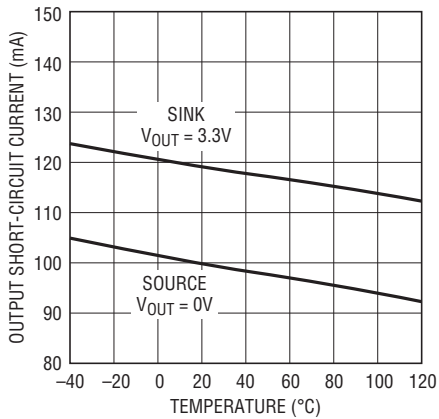

285012 G04

Driver Output Low/High Voltage vs Output Current

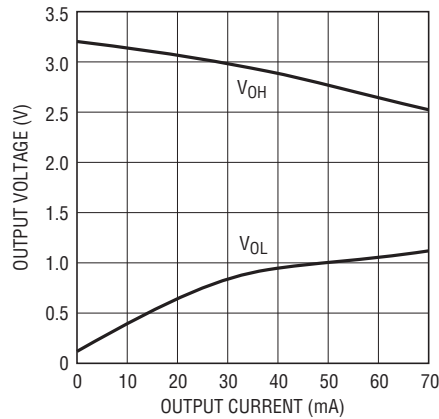

285012 G05

Driver Differential Output Voltage vs Temperature

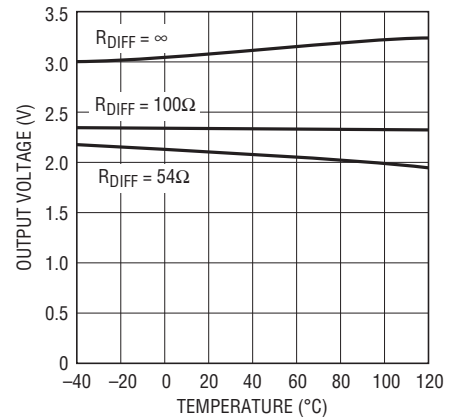

285012 G06

Receiver Output Voltage vs Output Current (Source and Sink)

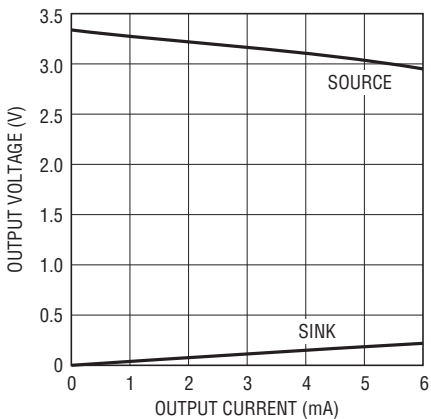

285012 G07

Receiver Propagation Delay vs Temperature

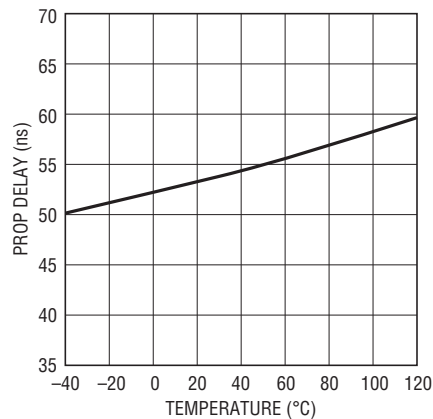

285012 G08

Supply Current vs Data Rate

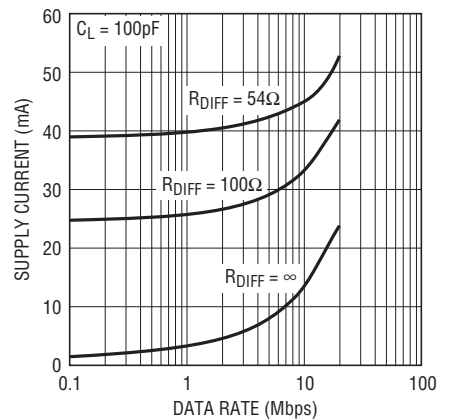

285012 G09

285012fc

PIN FUNCTIONS

RO: Receiver Output. If the receiver output is enabled (\overline{RE} low) and $A > B$ by 200mV, then RO will be high. If $A < B$ by 200mV, then RO will be low. If the receiver inputs are open, shorted, or terminated without a valid signal, RO will be high.

\overline{RE} : Receiver Enable. A low enables the receiver. A high input forces the receiver output into a high impedance state.

DE: Driver Enable. A high on DE enables the driver. A low input will force the driver outputs into a high impedance. If \overline{RE} is high with DE low, the part will enter a low power shutdown state.

DI: Driver Input. If the driver outputs are enabled (DE high), then a low on DI forces the driver positive output low and negative output high. A high on DI, with the driver outputs enabled, forces the driver positive output high and negative output low.

GND: Ground.

Y: Noninverting Driver Output for LTC2851 and LTC2852. High-impedance when driver disabled or unpowered.

Z: Inverting Driver Output for LTC2851 and LTC2852. High-impedance when driver disabled or unpowered.

A: Noninverting Receiver Input (and Noninverting Driver Output for LTC2850). Impedance is $>96k\Omega$ in receive mode or unpowered.

B: Inverting Receiver Input (and Inverting Driver Output for LTC2850). Impedance is $>96k\Omega$ in receive mode or unpowered.

V_{CC} : Positive Supply. $3V < V_{CC} < 3.6V$. Bypass with 0.1 μ F ceramic capacitor.

Exposed Pad: Ground. The exposed pads on the DFN packages must be soldered to ground.

FUNCTION TABLES

LTC2850

Logic Inputs		Mode	A, B	RO
DE	\overline{RE}			
0	0	Receive	R_{IN}	Driven
0	1	Shutdown	R_{IN}	High-Z
1	0	Transceive	Driven	Driven
1	1	Transmit	Driven	High-Z

LTC2852

Logic Inputs		Mode	A, B	Y, Z	RO
DE	\overline{RE}				
0	0	Receive	R_{IN}	High-Z	Driven
0	1	Shutdown	R_{IN}	High-Z	High-Z
1	0	Transceive	R_{IN}	Driven	Driven
1	1	Transmit	R_{IN}	Driven	High-Z

BLOCK DIAGRAM

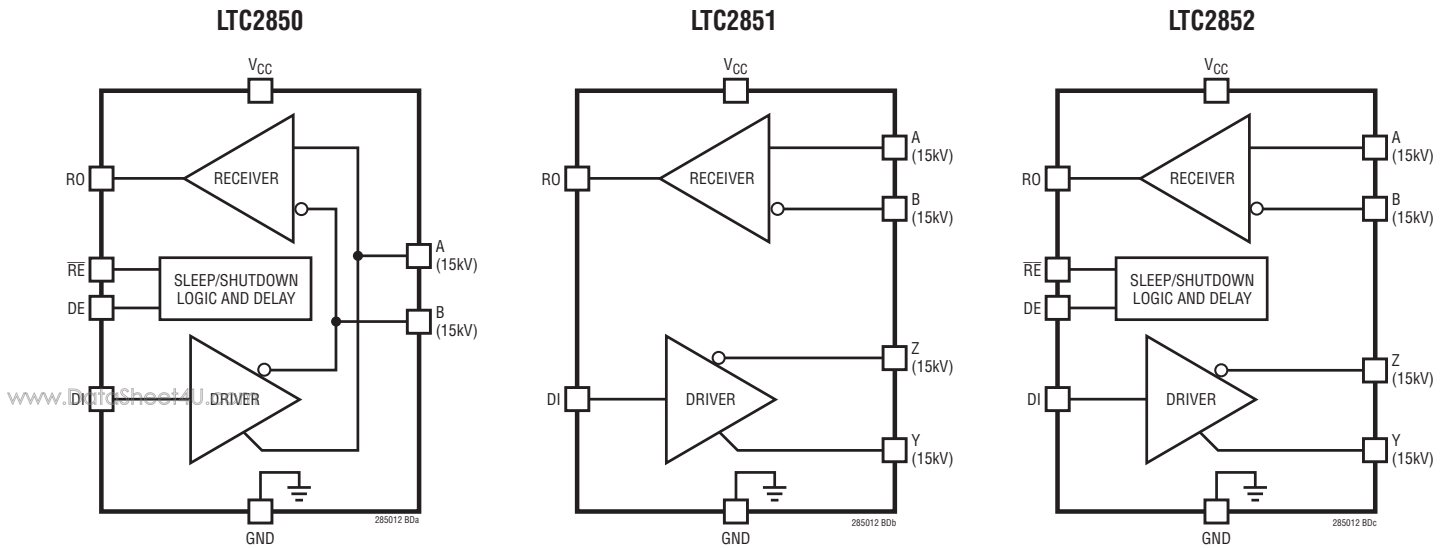

APPLICATIONS INFORMATION

Driver

The driver provides full RS485/RS422 compatibility. When enabled, if DI is high, Y-Z is positive for the full-duplex devices (LTC2851, LTC2852) and A-B is positive for the half-duplex device (LTC2850).

When the driver is disabled, both outputs are high-impedance. For the full-duplex devices, the leakage on the driver output pins is guaranteed to be less than $10\mu\text{A}$ over the entire common mode range of -7V to 12V . On the half-duplex LTC2850, the impedance is dominated by the receiver input resistance, R_{IN} .

Driver Overvoltage and Overcurrent Protection

The driver outputs are protected from short-circuits to any voltage within the Absolute Maximum range of ($V_{CC} - 15\text{V}$) to 15V . The typical peak current in this condition does not exceed 180mA .

If a high driver output is shorted to a voltage just above V_{CC} , a reverse current will flow into the supply. When this voltage exceeds V_{CC} by about 1.4V , the reverse current turns off. Preventing the driver from turning off with outputs shorted to output voltages just above V_{CC} keeps the driver

active even for receiver loads that have a positive common mode with respect to the driver – a valid condition.

The worst-case peak reverse short-circuit current can be as high as 300mA in extreme cold conditions. If this current can not be absorbed by the supply, a 3.6V zener diode can be added in parallel with the supply to sink this current.

All devices also feature thermal shutdown protection that disables the driver and receiver in case of excessive power dissipation (see Note 4).

Receiver and Failsafe

With the receiver enabled, when the absolute value of the differential voltage between the A and B pins is greater than 200mV , the state of RO will reflect the polarity of (A-B).

These parts have a failsafe feature that guarantees the receiver output to be in a logic-high state when the inputs are either shorted, left open, or terminated but not driven. This failsafe feature is guaranteed to work for inputs spanning the entire common mode range of -7V to 12V .

The receiver output is internally driven high (to V_{CC}) or low (to ground) with no external pull-up needed. When the receiver is disabled the RO pin becomes High-Z with leakage of less than $\pm 1\mu\text{A}$ for voltages within the supply range.

APPLICATIONS INFORMATION

Receiver Input Resistance

The receiver input resistance from A or B to ground is guaranteed to be greater than 96k (C, I-Grade). This is 8x higher than the requirements for the RS485 standard and thus this receiver represents a one-eighth unit load. This, in turn, means that 8x the standard number of receivers, or 256 total, can be connected to a line without loading it beyond what is specified in the RS485 standard. The receiver input resistance from A or B to ground on high temperature H-Grade parts is greater than 48k providing a one-quarter unit load. The high input resistance of the receiver is maintained whether it is enabled or disabled, powered or unpowered.

Supply Current

The unloaded static supply currents in these devices are very low, typically under 500 μ A for all modes of operation. In applications with resistively terminated cables, the supply current is dominated by the driver load. For example, when using two 120 Ω terminators with a differential driver output voltage of 2V, the DC load current is 33mA, which is sourced by the positive voltage supply. Power supply current increases with toggling data due to capacitive loading and this term can increase significantly at high data rates. Figure 13 shows supply current vs data rate for two different capacitive loads for the circuit configuration of Figure 4.

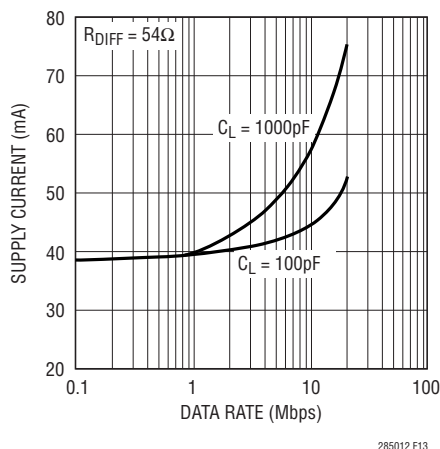

Figure 13. Supply Current vs Data Rate

High Speed Considerations

A ground plane layout is recommended. A 0.1 μ F bypass capacitor less than one-quarter inch away from the V_{CC} pin is also recommended. The PC board traces connected to signals A/B and Z/Y should be symmetrical and as short as possible to maintain good differential signal integrity. To minimize capacitive effects, the differential signals should be separated by more than the width of a trace and should not be routed on top of each other if they are on different signal planes.

Care should be taken to route outputs away from any sensitive inputs to reduce feedback effects that might cause noise, jitter, or even oscillations. For example, in the full-duplex devices, DI and A/B should not be routed near the driver or receiver outputs.

The logic inputs have 150mV of hysteresis to provide noise immunity. Fast edges on the outputs can cause glitches in the ground and power supplies which are exacerbated by capacitive loading. If a logic input is held near its threshold (typically 1.5V), a noise glitch from a driver transition may exceed the hysteresis levels on the logic and data input pins causing an unintended state change. This can be avoided by maintaining normal logic levels on the pins and by slewing inputs through their thresholds by faster than 1V/ μ s when transitioning. Good supply decoupling and proper driver termination also reduce glitches caused by driver transitions.

Cable Length vs Data Rate

For a given data rate, the maximum transmission distance is bounded by the cable properties. A curve of cable length vs data rate compliant with the RS485/RS422 standards is shown in Figure 14. Three regions of this curve reflect different performance limiting factors in data transmission. In the flat region of the curve, maximum distance

APPLICATIONS INFORMATION

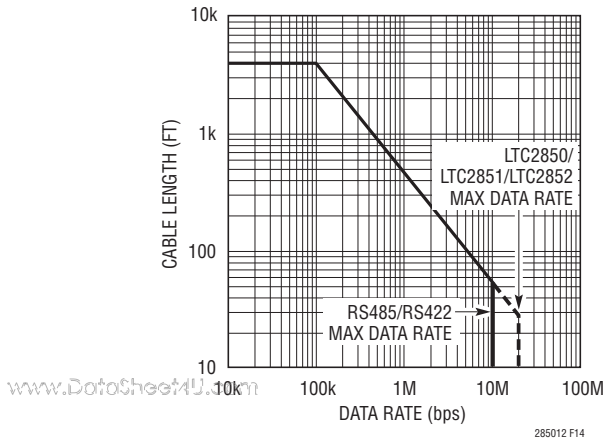
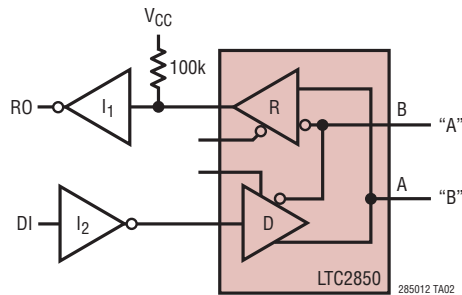

Figure 14. Cable Length vs Data Rate (RS485/RS422 Standard Shown in Solid Line)

is determined by resistive losses in the cable. The downward sloping region represents limits in distance and data rate due to AC losses in the cable. The solid vertical line represents the specified maximum data rate in the RS485/RS422 standards. The dashed lines at 20Mbps show the maximum data rates of the LTC2850, LTC2851, and LTC2852.

TYPICAL APPLICATIONS

Failsafe "0" Application (Idle State = Logic "0")



Multi-Node Network with End Termination Using the LTC2850 and LTC2854

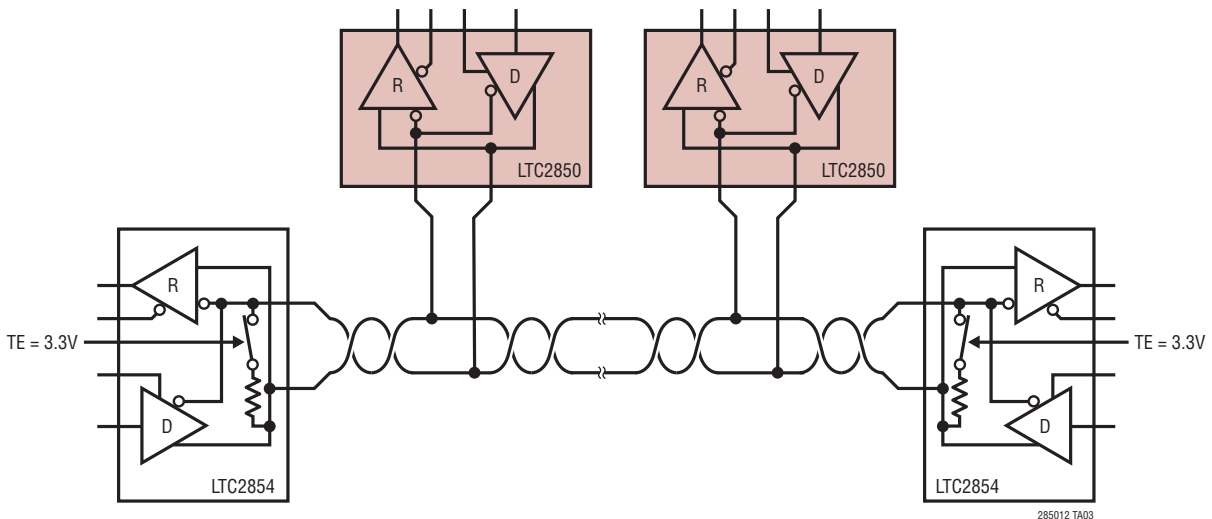

285012fc

PACKAGE DESCRIPTION

DD Package
8-Lead Plastic DFN (3mm × 3mm)
 (Reference LTC DWG # 05-08-1698)

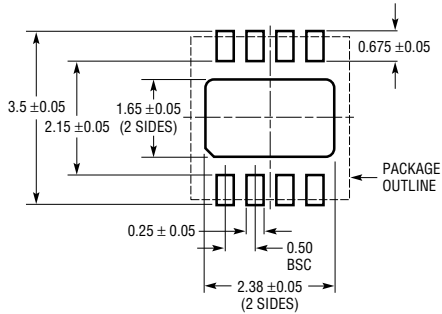

RECOMMENDED SOLDER PAD PITCH AND DIMENSIONS

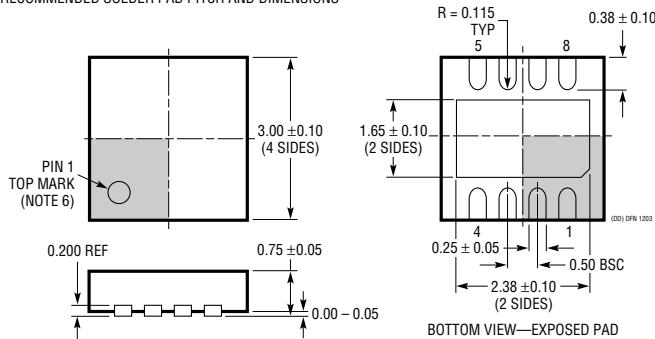

- NOTE:
1. DRAWING TO BE MADE A JEDEC PACKAGE OUTLINE M0-229 VARIATION OF (WEED-1)
 2. DRAWING NOT TO SCALE
 3. ALL DIMENSIONS ARE IN MILLIMETERS
 4. DIMENSIONS OF EXPOSED PAD ON BOTTOM OF PACKAGE DO NOT INCLUDE MOLD FLASH. MOLD FLASH, IF PRESENT, SHALL NOT EXCEED 0.15mm ON ANY SIDE
 5. EXPOSED PAD SHALL BE SOLDER PLATED
 6. SHADED AREA IS ONLY A REFERENCE FOR PIN 1 LOCATION ON TOP AND BOTTOM OF PACKAGE

DD Package
10-Lead Plastic DFN (3mm × 3mm)
 (Reference LTC DWG # 05-08-1699)

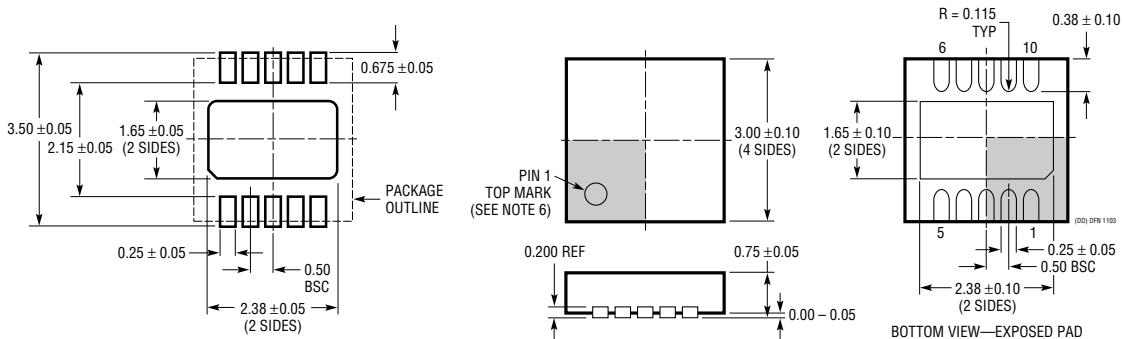

RECOMMENDED SOLDER PAD PITCH AND DIMENSIONS

- NOTE:
1. DRAWING TO BE MADE A JEDEC PACKAGE OUTLINE M0-229 VARIATION OF (WEED-2). CHECK THE LTC WEBSITE DATA SHEET FOR CURRENT STATUS OF VARIATION ASSIGNMENT
 2. DRAWING NOT TO SCALE
 3. ALL DIMENSIONS ARE IN MILLIMETERS
 4. DIMENSIONS OF EXPOSED PAD ON BOTTOM OF PACKAGE DO NOT INCLUDE MOLD FLASH. MOLD FLASH, IF PRESENT, SHALL NOT EXCEED 0.15mm ON ANY SIDE
 5. EXPOSED PAD SHALL BE SOLDER PLATED
 6. SHADED AREA IS ONLY A REFERENCE FOR PIN 1 LOCATION ON THE TOP AND BOTTOM OF PACKAGE

PACKAGE DESCRIPTION

MS8 Package 8-Lead Plastic MSOP

(Reference LTC DWG # 05-08-1660 Rev F)

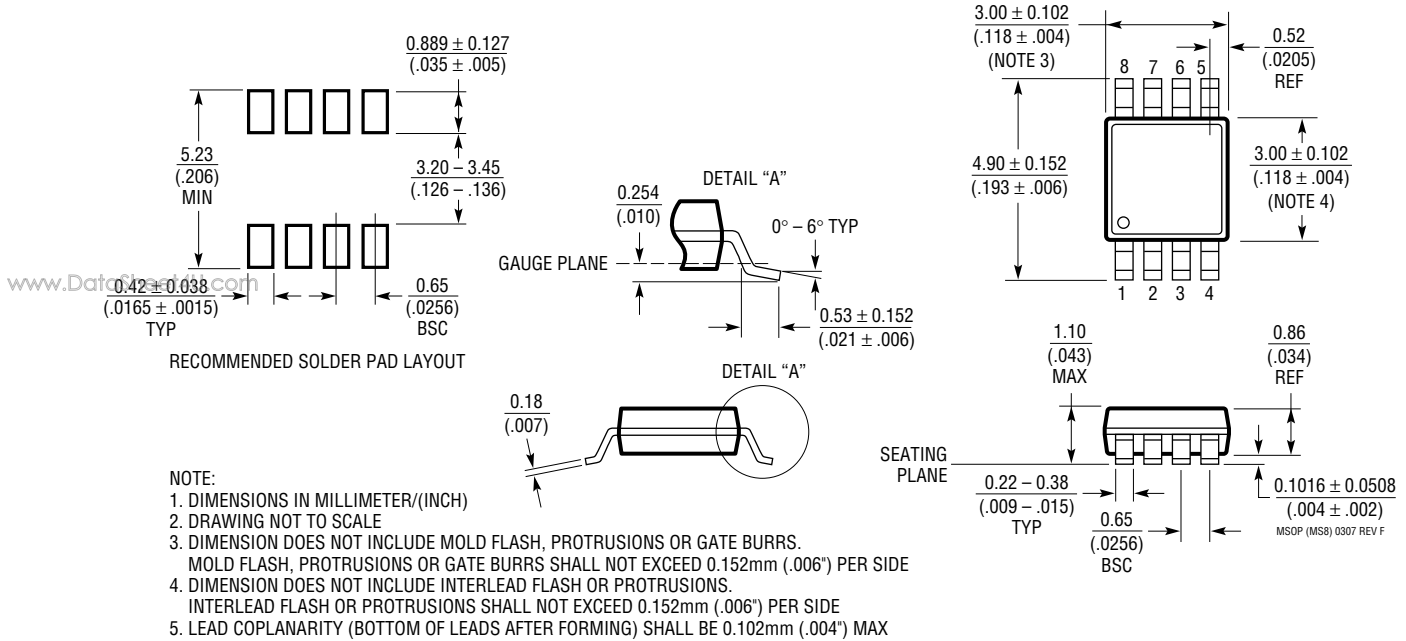

MS Package 10-Lead Plastic MSOP

(Reference LTC DWG # 05-08-1661 Rev E)

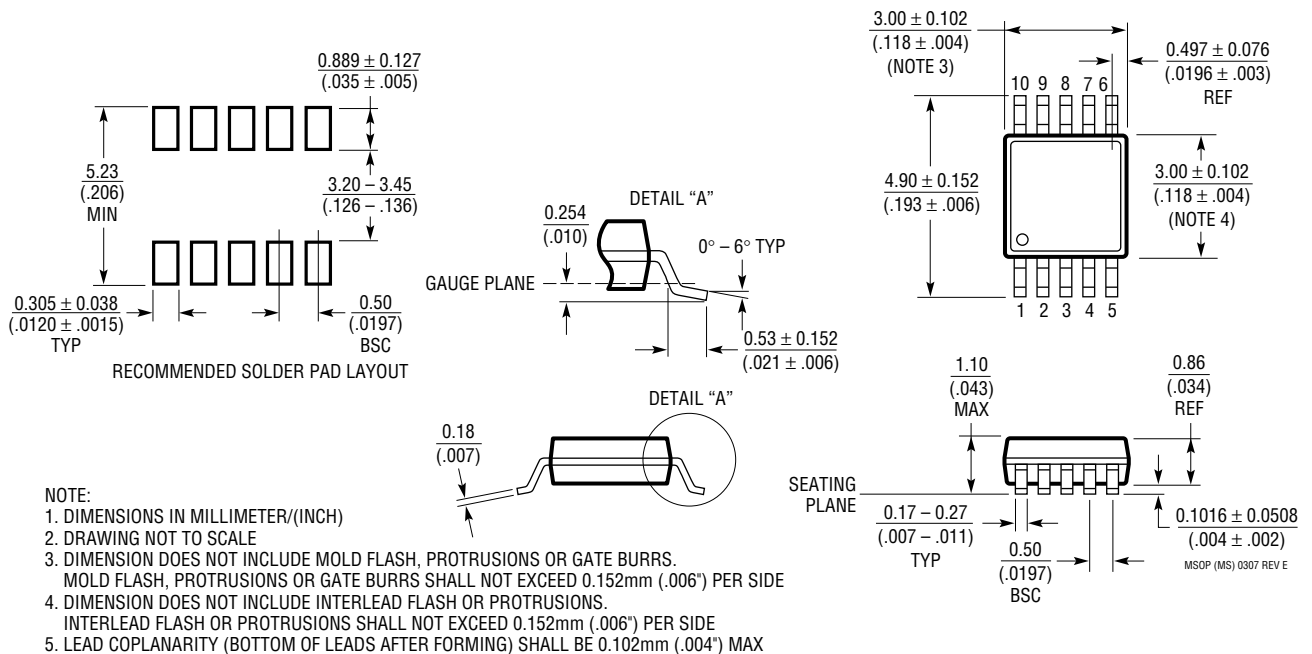

PACKAGE DESCRIPTION

S8 Package
8-Lead Plastic Small Outline (Narrow .150 Inch)
 (Reference LTC DWG # 05-08-1610)

www.DataSheet4U.com

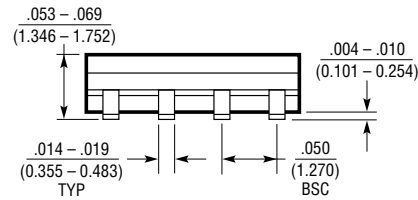
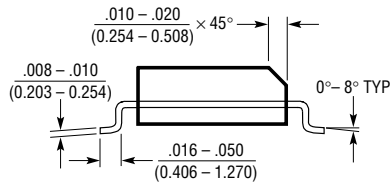
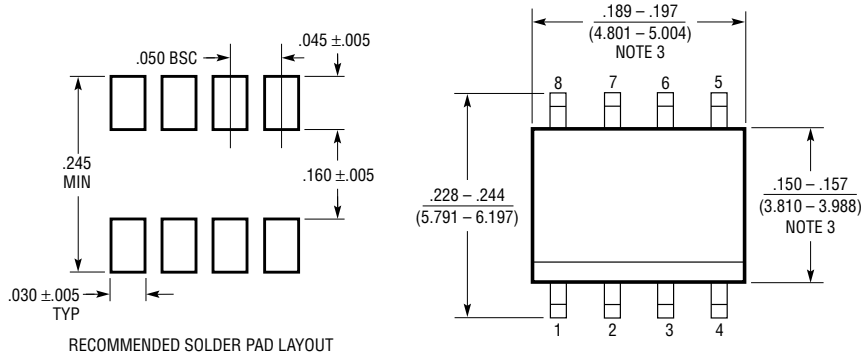

- NOTE:
 1. DIMENSIONS IN $\frac{\text{INCHES}}{\text{MILLIMETERS}}$
 2. DRAWING NOT TO SCALE
 3. THESE DIMENSIONS DO NOT INCLUDE MOLD FLASH OR PROTRUSIONS.
 MOLD FLASH OR PROTRUSIONS SHALL NOT EXCEED .006" (0.15mm)

S08 0303

S Package
14-Lead Plastic Small Outline (Narrow .150 Inch)
 (Reference LTC DWG # 05-08-1610)

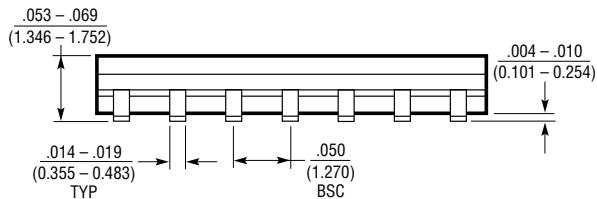
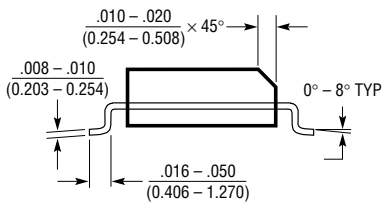
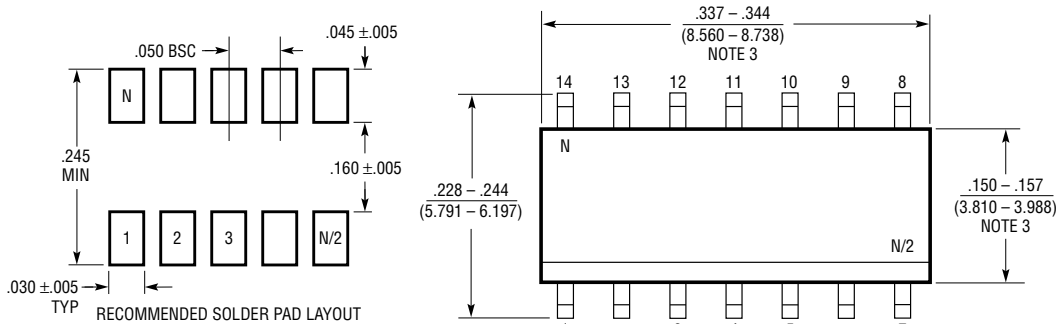

- NOTE:
 1. DIMENSIONS IN $\frac{\text{INCHES}}{\text{MILLIMETERS}}$
 2. DRAWING NOT TO SCALE
 3. THESE DIMENSIONS DO NOT INCLUDE MOLD FLASH OR PROTRUSIONS.
 MOLD FLASH OR PROTRUSIONS SHALL NOT EXCEED .006" (0.15mm)

S14 0502

285012fc

LTC2850/LTC2851/LTC2852

TYPICAL APPLICATION

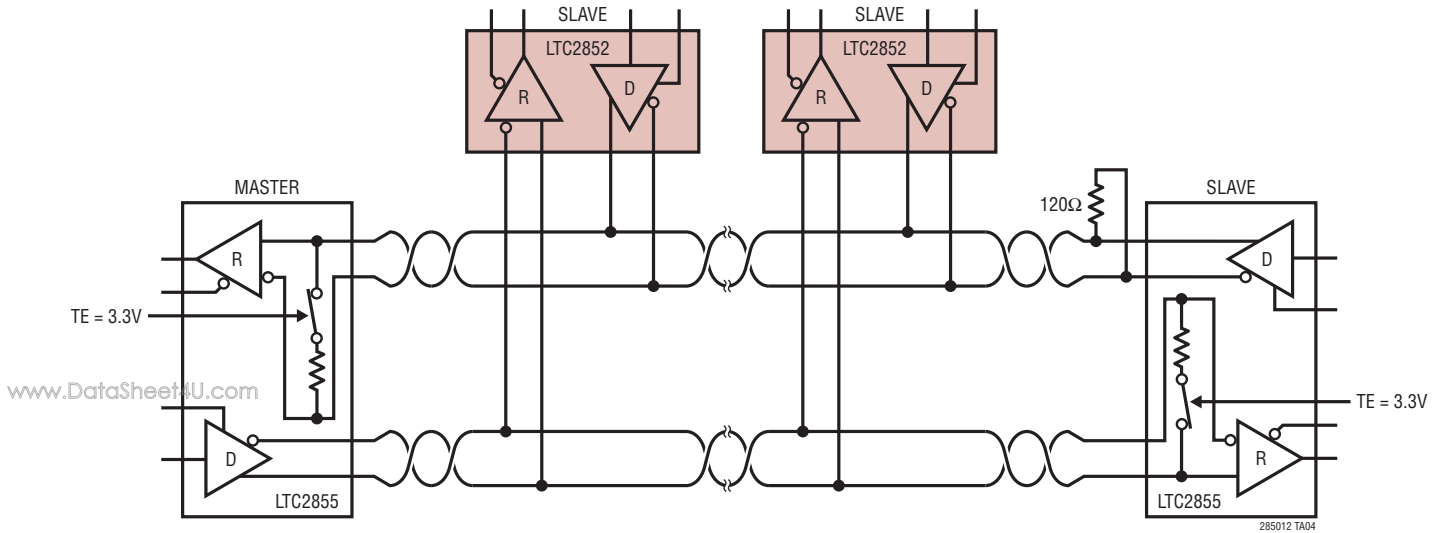

Full Duplex Network Using the LTC2852 and LTC2855

RELATED PARTS

PART NUMBER	DESCRIPTION	COMMENTS
LTC485	Low Power RS485 Interface Transceiver	$I_{CC} = 300\mu A$ (Typ)
LTC491	Differential Driver and Receiver Pair	$I_{CC} = 300\mu A$
LTC1480	3.3V Ultralow Power RS485 Transceiver	3.3V Operation
LTC1483	Ultralow Power RS485 Low EMI Transceiver	Controlled Driver Slew Rate
LTC1485	Differential Bus Transceiver	10Mbps Operation
LTC1487	Ultralow Power RS485 with Low EMI, Shutdown and High Input Impedance	Up to 256 Transceiver on the Bus
LTC1520	50Mbps Precision Quad Line Receiver	Channel-to-Channel Skew 400ps (Typ)
LTC1535	Isolated RS485 Full-Duplex Transceiver	2500V _{RMS} Isolation in Surface Mount Package
LTC1685	52Mbps RS485 Transceiver with Precision Delay	Propagation Delay Skew 500ps (Typ)
LT1785	60V Fault Protected RS485 Transceiver	60V Tolerant, 15kV ESD
LTC2854/LTC2855	3.3V 20Mbps RS485/RS422 Transceivers with Integrated Switchable Termination	3.3V Operation, Integrated, Switchable, 120Ω Termination Resistor, 25kV ESD (LTC2854), 15kV ESD (LTC2855)
LTC2856-1	20Mbps and Slew Rate-Limited, 15kV RS485/RS422 Transceiver	15kV ESD
LTC2859/LTC2861	20Mbps RS485/RS422 Transceiver with Integrated Switchable Termination	Integrated, Switchable, 120Ω Termination Resistor, 15kV ESD

285012fc