

VI TELEFILTER

Filter specification

TFS 170D

1/5

Measurement condition

Ambient temperature:	23	°C
Input power level:	0	dBm
Terminating impedance: *		
Input:	1250 Ω	-3,3 pF
Output:	1250 Ω	-3,3 pF
External Coil:	150	nH

Characteristics

Remark:

The reference level for the relative attenuation a_{rel} of the TFS 170D is the minimum of the pass band attenuation. This value is defined as the insertion loss a_e . The nominal frequency f_N is fixed at 170,2 MHz without any tolerance. The values of relative attenuation a_{rel} are guaranteed for the whole operating temperature range. The frequency shift of the filter in the operating temperature range is included in the production tolerance scheme.

D a t a		typ. value	tolerance / limit
Insertion loss (reference level)	a_e	3,8 dB	max. 5,0 dB
Nominal frequency	f_N	-	170,2 MHz
Passband	PB	-	$f_N \pm 100,0$ kHz
Bandwidth 3 dB	BW	320 kHz	max. 350 kHz
Relative attenuation	a_{rel}		
$f_N \pm 100$ kHz		1,2 dB	max. 3 dB
$f_N \pm 600$ kHz ... $f_N \pm 800$ kHz		37 dB	min. 27 dB
$f_N - 800$ kHz ... $f_N - 2,3$ MHz		51 dB	min. 31 dB
$f_N - 2,3$ MHz ... $f_N - 2,5$ MHz		54 dB	min. 50 dB
$f_N - 2,5$ MHz ... $f_N - 18,0$ MHz		51 dB	min. 46 dB
$f_N - 18,0$ MHz ... $f_N - 36,0$ MHz		56 dB	min. 50 dB
$f_N + 800,0$ MHz ... $f_N + 2,4$ MHz		40 dB	min. 31 dB
$f_N + 2,4$ MHz ... $f_N + 12,0$ MHz		51 dB	min. 46 dB
$f_N + 12,0$ MHz ... $f_N + 36,0$ MHz		53 dB	min. 50 dB
Group delay ripple within PB		0,6 μs	max. 1 μs
Input power level		-	max. 0 dBm
Operating temperature range	OTR	-	- 20 °C ... + 80 °C
Storage temperature range		-	- 40 °C ... + 85 °C
Frequency inversion temperature		+ 25 °C	
Temperature coefficient of frequency	TC_f^{**}	- 0,036 ppm/K ²	

*) The terminating impedances depend on parasitics and q-values of matching elements and the board used, and are to be understood as reference values only. Should there be additional questions do not hesitate to ask for an application note or contact our design team.

**) $\Delta f(\text{Hz}) = TC_f(\text{ppm/K}^2) \times (T - T_0)^2 \times f_{T0}(\text{MHz})$

Generated:

Checked / Approved:

Tele Filter GmbH
Potsdamer Straße 18
D 14 513 TELTOW / Germany
Tel: (+49) 3328 4784-0 / Fax: (+49) 3328 4784-30
E-Mail: tft@telefilter.com

VI TELEFILTER reserves the right to make changes to the product(s) and/or information contained herein without notice. No liability is assumed as a result of their use or application. No rights under any patent accompany the sale of any such product(s) or information.

Filter characteristic

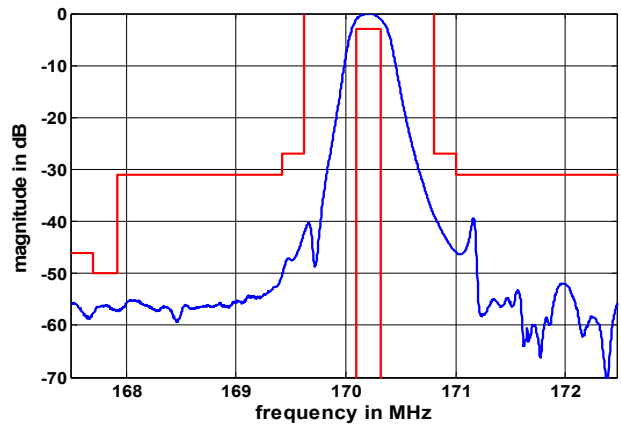
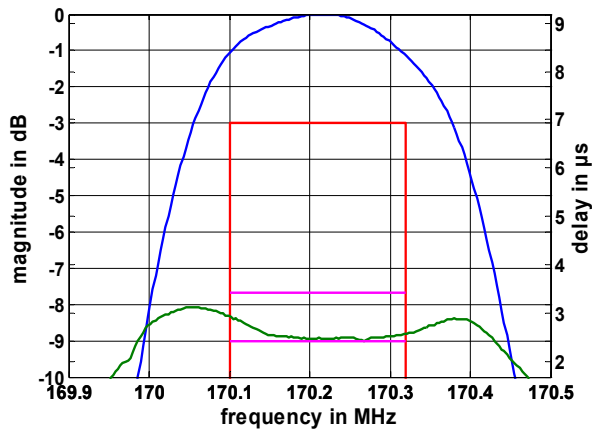

Construction and pin connection

(All dimensions in mm)

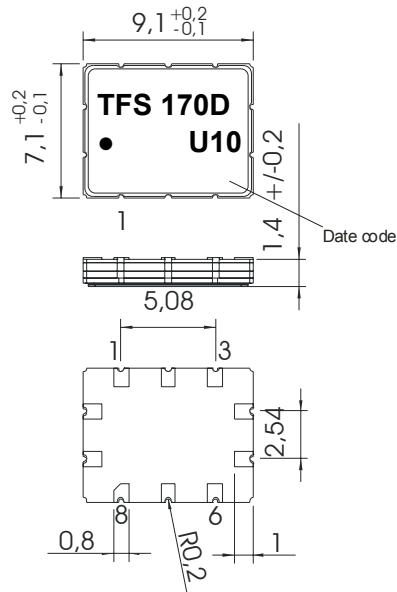

1	Output
2	Output
3	Ground
4	Ground
5	Ground
6	Input
7	Input
8	Ground
9	Ground
10	Ground

Date code: Year + week

U	2006
V	2007
W	2008
...	

50 Ω Test circuit

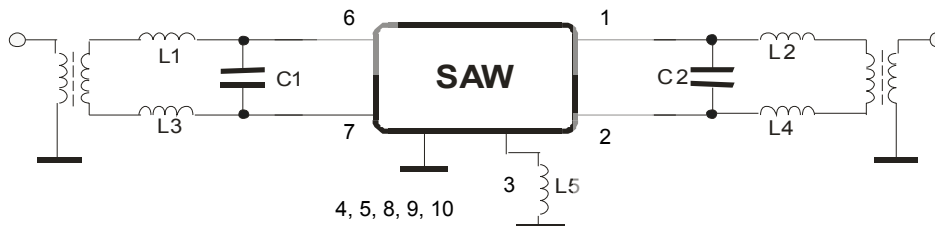

Tele Filter GmbH
 Potsdamer Straße 18
 D 14 513 TELTOW / Germany
 Tel: (+49) 3328 4784-0 / Fax: (+49) 3328 4784-30
 E-Mail: tft@telefilter.com

VI TELEFILTER reserves the right to make changes to the product(s) and/or information contained herein without notice. No liability is assumed as a result of their use or application. No rights under any patent accompany the sale of any such product(s) or information.

Stability characteristics, reliability

After the following tests the filter shall meet the whole specification:

1. Shock: 500g, 1 ms, half sine wave, 3 shocks each plane;
DIN IEC 68 T2 - 27
2. Vibration: 10 Hz to 500 Hz, 0,35 mm or 5 g respectively, 1 octave per min, 10 cycles per plan, 3 plans;
DIN IEC 68 T2 - 6
3. Change of temperature: -55 °C to 125°C / 30 min. each / 10 cycles
DIN IEC 68 part 2 – 14 Test N
4. Resistance to solder heat (reflow): reflow possible: twice max.;
for temperature conditions refer to the attached "Air reflow temperature conditions" on page 4;

This filter is RoHS compliant (2002/95/EG, 2005/618/EG)

Packing

Tape & Reel: IEC 286 – 3, with exception of value for N and minimum bending radius;
tape type II, embossed carrier tape with top cover tape on the upper side;

max. pieces of filters per reel:	
reel of empty components at start:	min. 300 mm
reel of empty components at start including leader:	min. 500 mm
trailer:	min. 300 mm

Tape (all dimensions in mm)

- W : 16,00 ± 0,3
- Po : 4,00 ± 0,1
- Do : 1,50 +0,1/-0
- E : 1,75 ± 0,10
- F : 7,50 ± 0,10
- G(min) : 0,60
- P2 : 2,00 ± 0,1
- P1 : 12,00 ± 0,1
- D1(min) : 1,50 +0,1/-0
- Ao : 7,60 ± 0,10
- Bo : 9,60 ± 0,10
- Ct : 13,5

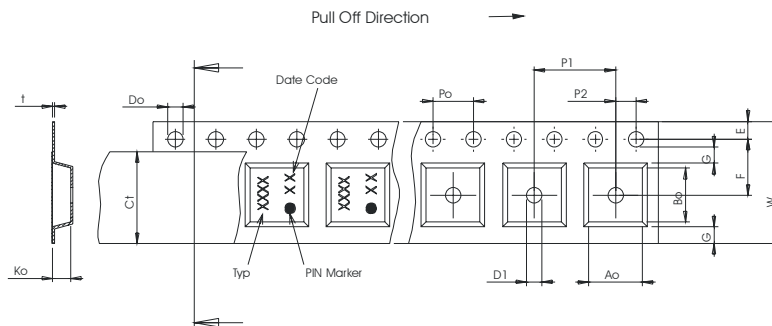

Reel (all dimensions in mm)

- A : 330
- W1 : 16,4
- W2(max) : 22,4
- N(min) : 50
- C : 13,0

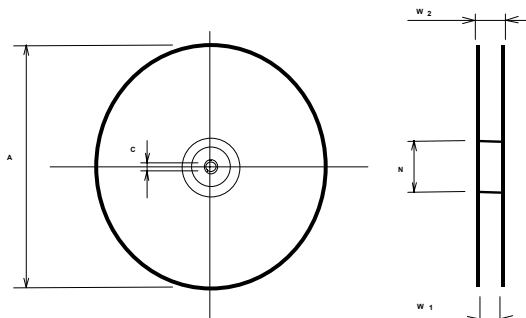

The minimum bending radius is 45 mm.

Tele Filter GmbH
Potsdamer Straße 18
D 14 513 TELTOW / Germany
Tel: (+49) 3328 4784-0 / Fax: (+49) 3328 4784-30
E-Mail: tft@telefilter.com

VI TELEFILTER reserves the right to make changes to the product(s) and/or information contained herein without notice. No liability is assumed as a result of their use or application. No rights under any patent accompany the sale of any such product(s) or information.

Air reflow temperature conditions

Conditions	Exposure
Average ramp-up rate (30°C to 217°C)	less than 3°C/second
> 100°C	between 300 and 600 seconds
> 150°C	between 240 and 500 seconds
> 217°C	between 30 and 150 seconds
Peak temperature	max. 260°C
Time within 5°C of actual peak temperature	between 10 and 30 seconds
Cool-down rate (Peak to 50°C)	less than 6°C/second
Time from 30°C to Peak temperature	no greater than 300 seconds

Chip-mount air reflow profile

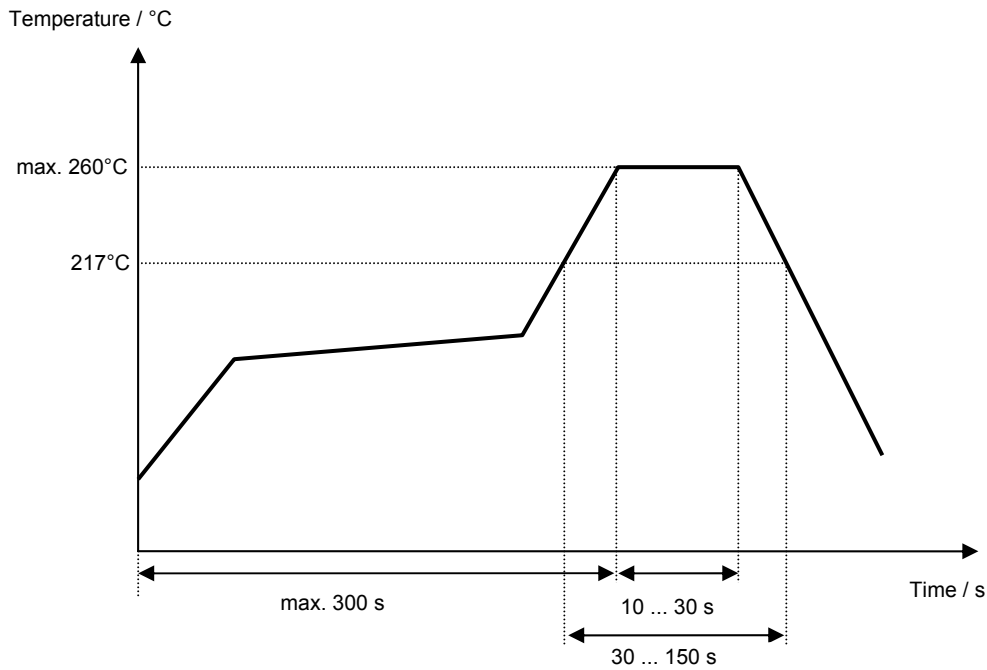

Tele Filter GmbH
 Potsdamer Straße 18
 D 14 513 TELTOW / Germany
 Tel: (+49) 3328 4784-0 / Fax: (+49) 3328 4784-30
 E-Mail: tft@telefilter.com

VI TELEFILTER reserves the right to make changes to the product(s) and/or information contained herein without notice. No liability is assumed as a result of their use or application. No rights under any patent accompany the sale of any such product(s) or information.

VI TELEFILTER**Filter specification****TFS 170D****5/5****History**

Version	Reason of Changes	Name	Date
1.0	- Generation of development specification	Roßbach	29.01.1998
1.1	- Generation of filter specification, added typical values and filter characteristic	Martens	14.06.2005
1.2	- Add external coil - Correct stability characteristics	Alawneh	10.03.2006

Tele Filter GmbH
Potsdamer Straße 18
D 14 513 TELTOW / Germany
Tel: (+49) 3328 4784-0 / Fax: (+49) 3328 4784-30
E-Mail: tft@telefilter.com

VI TELEFILTER reserves the right to make changes to the product(s) and/or information contained herein without notice. No liability is assumed as a result of their use or application. No rights under any patent accompany the sale of any such product(s) or information.