

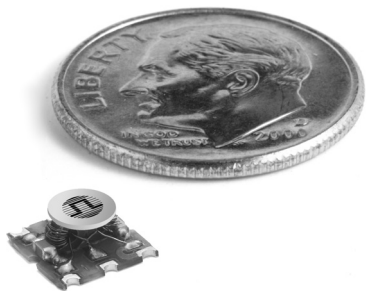





RF SPLITTER/COMBINER

For RF Return Path Applications in Cable TV Products and Distribution Equipment : 2-Way; 0°



-  Operating bandwidth: 5MHz to 65MHz
-  Ideal for cable TV distribution equipment and set top box applications
-  High Isolation
-  Excellent Return Loss
-  235°C peak IR reflow temperature rating

Electrical Specifications @ 25°C — Operating Temperature -40°C to +85°C

Part Number	Frequency (MHz)	Z (Ω)	Isolation 5-65 MHz (dB TYP/MIN)	Return Loss (5-65 MHz)		Insertion Loss (>3dB)	Phase Unbalance	Amplitude Unbalance
				INPUT (TYP/MIN)	OUTPUT (TYP/MIN)	5-65 MHz (dB TYP/MAX)	5-65 MHz (deg MAX)	5-65 MHz (dB MAX)
CX4004L	5 - 65	75	40/26	34/24	31/23	0.22/0.40	1	0.3

NOTE: Optional Tape & Reel packaging can be ordered by adding a "T" suffix to the part number (ex: CX4004LT).

Mechanical

CX4004L

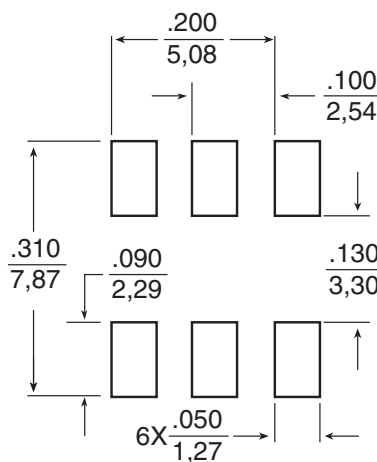
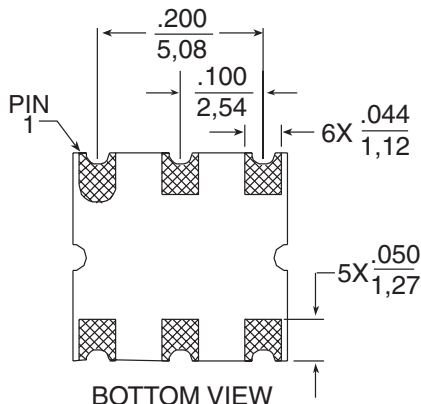
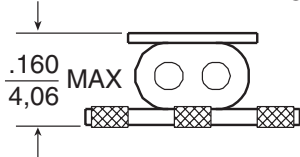
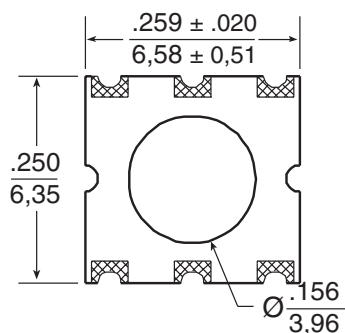

SUGGESTED PAD LAYOUT

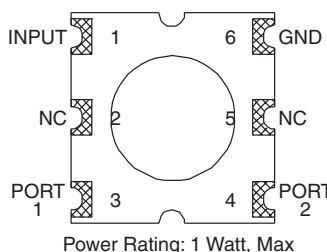

Weight0.35 grams
 Tape & Reel2200/reel
 Dimensions: Inches
 mm
 Unless otherwise specified,
 all tolerances are ± .010
 0,25

RF SPLITTER/COMBINER

For RF Return Path Applications in Cable TV Products and Distribution Equipment : 2-Way; 0°



Typical Performance @ 25°C CX4004L

INSERTION LOSS

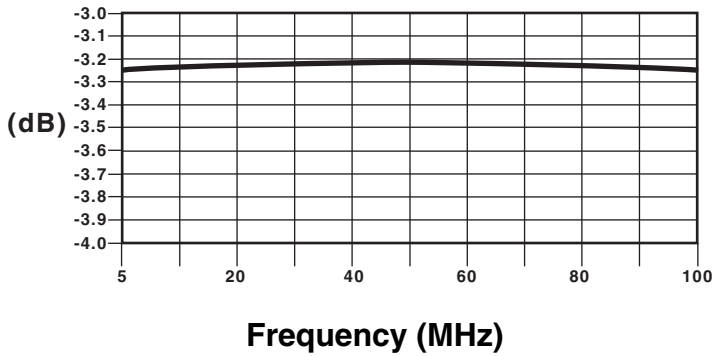

ISOLATION

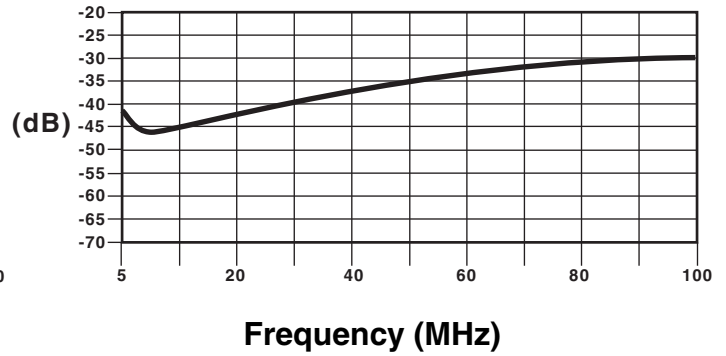

OUTPUT RETURN LOSS

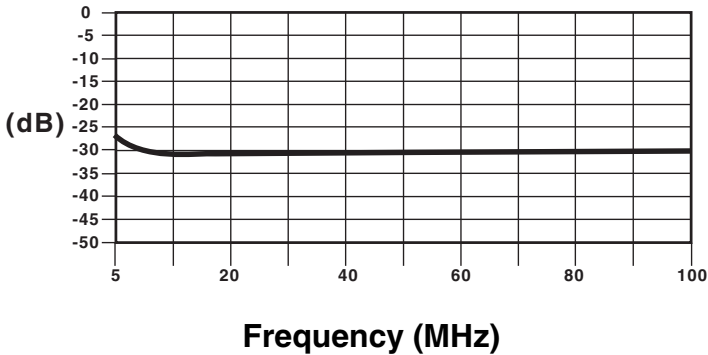

INPUT RETURN LOSS

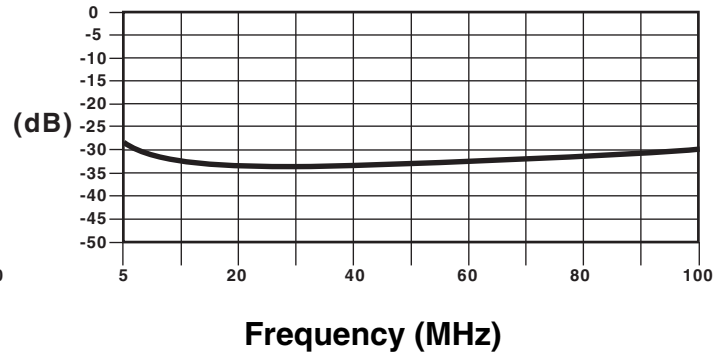

For More Information :

UNITED STATES (Worldwide)	UNITED KINGDOM (Northern Europe)	FRANCE (Southern Europe)	SINGAPORE (Southern Asia)	TAIWAN, R.O.C. (Northern Asia)	HONG KONG (China/Hong Kong)	DISTRIBUTOR
12220 World Trade Drive San Diego, CA 92128 U.S.A. http://www.pulseeng.com TEL: 858 674 8100 FAX: 858 674 8262	3 Huxley Road Surrey Research Park Guildford, Surrey GU2 5RE United Kingdom TEL: 44 1483 401700 FAX: 44 1483 401701	Zone Industrielle F-39270 Orgelet France TEL: 33 3 84 35 04 04 FAX: 33 3 84 25 46 41	150 Kampong Ampat #07-01/02 KA Centre Singapore 368324 TEL: 65 6287 8998 FAX: 65 6280 0080	3F-4, No. 81, Sec. 1 HsinTai Wu Road Hsi-Chih, Taipei Hsien Taiwan, R.O.C. Tel: 886 2 2698 0228 FAX: 886 2 2698 0948	9/F, Phase 2, Tai Sang Shatin Warehouse Centre 6 Wong Chuk Yeung Street Fotan, Shatin, Hong Kong TEL: 852 2788 6588 FAX: 852 2776 1055	

Performance warranty of products offered on this data sheet is limited to the parameters specified. Data is subject to change without notice. Other brand and product names mentioned herein may be trademarks or registered trademarks of their respective owners.