

64K x 4 Static RAM

L7C191/192

FEATURES

- ❑ 64K x 4 Static RAM with Separate I/O, Transparent Write (L7C191), or High Impedance Write (L7C192)
- ❑ Auto-Powerdown™ Design
- ❑ Advanced CMOS Technology
- ❑ High Speed — to 15 ns maximum
- ❑ Low Power Operation
 - Active: 265 mW typical at 45 ns
 - Standby: 10 mW typical
- ❑ Data Retention at 2 V for Battery Backup Operation
- ❑ Plug Compatible with IDT 71281/71282, Cypress CY7C191/192
- ❑ Package Styles Available:
 - 28-pin Plastic DIP
 - 28-pin CerDIP
 - 28-pin Plastic SOIC
 - 28-pin Plastic SOJ

DESCRIPTION

The L7C191 and L7C192 are high-performance, low-power CMOS static RAMs. The storage cells are organized as 65,536 words by 4 bits per word. Data In and Data Out are separate. These devices are available in five speeds with maximum access times from 15 ns to 45 ns.

Inputs and output are TTL compatible. Operation is from a single +5 V power supply. Power consumption is 265 mW (typical) at 45 ns. Dissipation drops to 100 mW (typical) when the memory is deselected (Enable is high).

Two standby modes are available. Proprietary Auto-Powerdown™ circuitry reduces power consumption automatically during read or write accesses which are longer than the

minimum access time, or when the memory is deselected. In addition, data may be retained in inactive storage with a supply voltage as low as 2 V. The L7C191 and L7C192 consume only 1.5 mW (typical) at 3 V, allowing effective battery backup operation.

The L7C191 and L7C192 provide asynchronous (unlocked) operation with matching access and cycle times. An active-low Chip Enable and a three-state bus output simplify the connection of several chips for increased storage capacity.

Memory locations are specified on address pins A0 through A15. Reading from a designated location is accomplished by presenting an address and driving \overline{CE} low while \overline{WE} remains high. The data in the addressed memory location will then appear on the Data Out pins within one access time. The output pins stay in a high-impedance state when \overline{WE} is low (L7C192 only) or \overline{CE} is high.

Writing to an addressed location is accomplished when the active-low \overline{CE} and \overline{WE} inputs are both low. Either signal may be used to terminate the write operation. The Data In and Data Out signals have the same polarity.

Latchup and static discharge protection are provided on-chip. The L7C191 and L7C192 can withstand an injection current of up to 200 mA on any pin without damage.

L7C191/192 BLOCK DIAGRAM

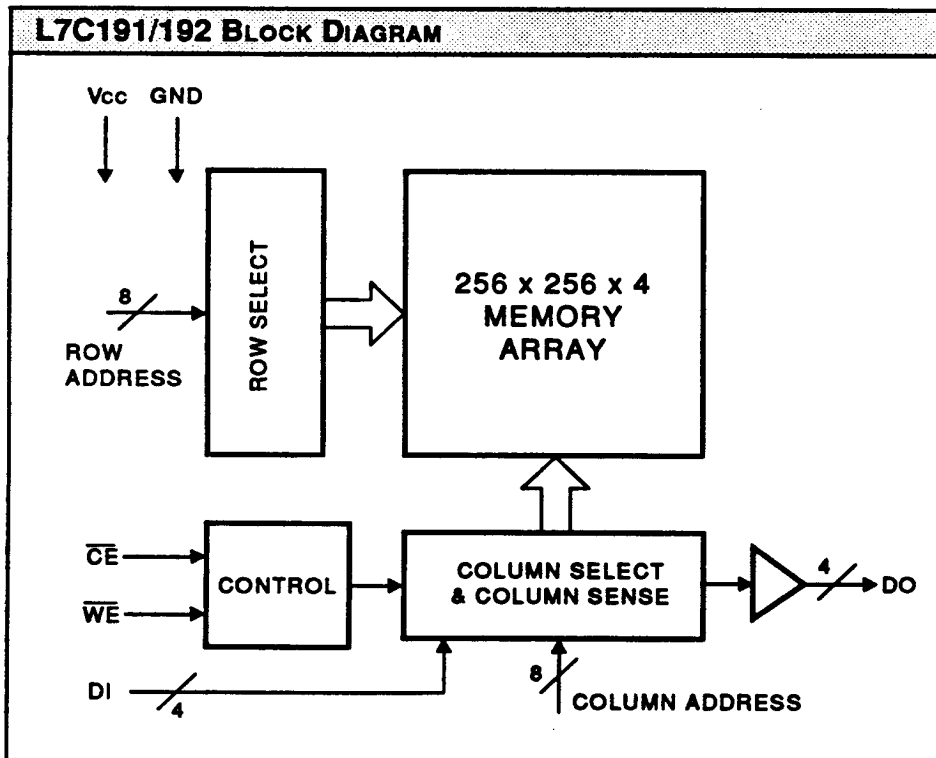

MAXIMUM RATINGS Above which useful life may be impaired (Notes 1, 2)	
Storage temperature	-65°C to +150°C
Operating ambient temperature	-55°C to +125°C
Vcc supply voltage with respect to ground	-0.5 V to +7.0 V
Input signal with respect to ground	-3.0 V to +7.0 V
Signal applied to high impedance output	-3.0 V to +7.0 V
Output current into low outputs	25 mA
Latchup current	> 200 mA

OPERATING CONDITIONS To meet specified electrical and switching characteristics		
Mode	Temperature Range (Ambient)	Supply Voltage
Active Operation, Commercial	0°C to +70°C	4.5 V ≤ Vcc ≤ 5.5 V
Active Operation, Military	-55°C to +125°C	4.5 V ≤ Vcc ≤ 5.5 V
Data Retention, Commercial	0°C to +70°C	2.0 V ≤ Vcc ≤ 5.5 V
Data Retention, Military	-55°C to +125°C	2.0 V ≤ Vcc ≤ 5.5 V

ELECTRICAL CHARACTERISTICS Over Operating Conditions						
Symbol	Parameter	Test Condition	Min	Typ	Max	Unit
VOH	Output High Voltage	IOH = -4.0 mA, Vcc = 4.5 V	2.4			V
VOL	Output Low Voltage	IOL = 8.0 mA			0.4	V
VIH	Input High Voltage		2.0		Vcc + 0.3	V
VIL	Input Low Voltage	(Note 3)	-3.0		0.8	V
IIX	Input Current	GND ≤ VIN ≤ Vcc	-10		+10	μA
IOZ	Output Leakage Current	GND ≤ VOUT ≤ Vcc, CE = Vcc	-10		+10	μA
IOS	Output Short Current	VOUT = GND, Vcc = Max (Note 4)			-350	mA
ICC2	Vcc Current, TTL Inactive	(Notes 5, 7)		20	40	mA
ICC3	Vcc Current, CMOS Standby	(Note 8)		2	10	mA
ICC4	Vcc Current, Data Retention	Vcc = 3.0 V (Note 9)		500	5000	μA
CIN	Input Capacitance	Ambient Temp = 25°C, Vcc = 5.0 V			5	pF
COU	Output Capacitance	Test Frequency = 1 MHz (Note 10)			7	pF

Symbol	Parameter	Test Condition	L7C191/192-					Unit
			45	35	25	20	15	
ICC1	Vcc Current, Active	(Notes 5, 6)	70	85	110	125	160	mA



SWITCHING CHARACTERISTICS *Over Operating Range (ns)*

READ CYCLE (Notes 11, 12, 22, 23, 24)

Symbol	Parameter	L7C191/192-									
		45		35		25		20		15	
		Min	Max	Min	Max	Min	Max	Min	Max	Min	Max
t _{AVAV}	Read Cycle Time	45		35		25		20		15	
t _{AVQV}	Address Valid to Output Valid (13, 14)		45		35		25		20		15
t _{AXQX}	Address Change to Output Change	3		3		3		3		3	
t _{CLQV}	Chip Enable Low to Output Valid (13, 15)		45		35		25		20		15
t _{CLQZ}	Chip Enable Low to Output Low Z (20, 21)	3		3		3		3		3	
t _{CHQZ}	Chip Enable High to Output High Z (20, 21)		15		15		10		8		5
t _{PU}	Input Transition to Power Up (10, 19)	0		0		0		0		0	
t _{PD}	Power Up to Power Down (10, 19)		45		35		25		20		20
t _{CHVL}	Chip Enable High to Data Retention (10)	0		0		0		0		0	

READ CYCLE — ADDRESS CONTROLLED (Notes 13, 14)

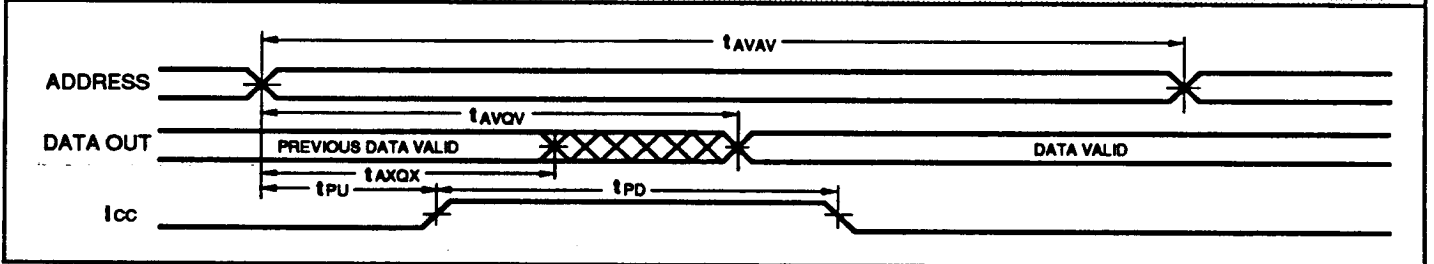

READ CYCLE — CE CONTROLLED (Notes 13, 15)

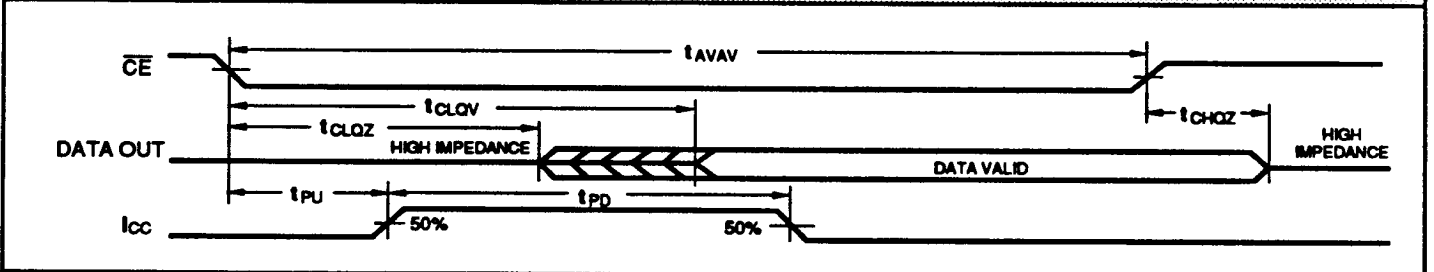

DATA RETENTION

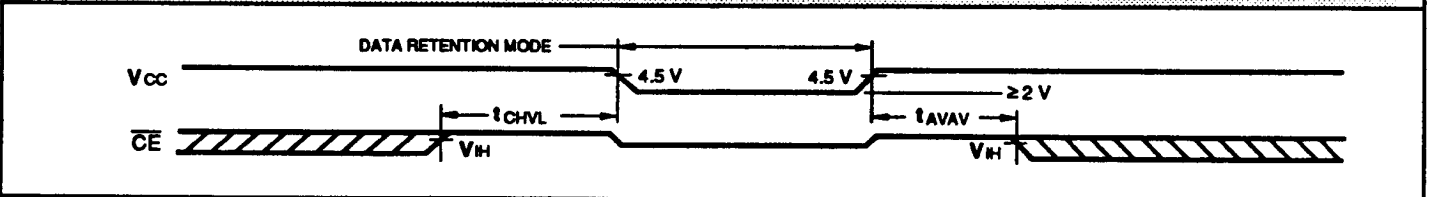

SWITCHING CHARACTERISTICS *Over Operating Range (ns)*

WRITE CYCLE (Notes 11, 12, 22, 23, 24)

Symbol	Parameter	L7C191/192-									
		45		35		25		20		15	
		Min	Max	Min	Max	Min	Max	Min	Max	Min	Max
tAVAV	Write Cycle Time	40		25		20		20		15	
tCLEW	Chip Enable Low to End of Write Cycle	30		25		15		15		12	
tAVBW	Address Valid to Beginning of Write Cycle	0		0		0		0		0	
tAVEW	Address Valid to End of Write Cycle	30		25		15		15		12	
tEWAX	End of Write Cycle to Address Change	0		0		0		0		0	
tWLEW	Write Enable Low to End of Write Cycle	20		20		15		15		12	
tDVEW	Data Valid to End of Write Cycle	15		15		10		10		7	
tEWDX	End of Write Cycle to Data Change	0		0		0		0		0	
tWHQZ	Write Enable High to Output Low Z (20, 21)	0		0		0		0		0	
tWLQZ	Write Enable Low to Output High Z (20, 21)		15		10		7		7		5
tWLOV	Write Enable Low to Output Valid		35		30		20		15		15
tDVOV	Data Valid to Output Valid		35		30		20		15		15

WRITE CYCLE — WE CONTROLLED (Notes 16, 17, 18, 19)

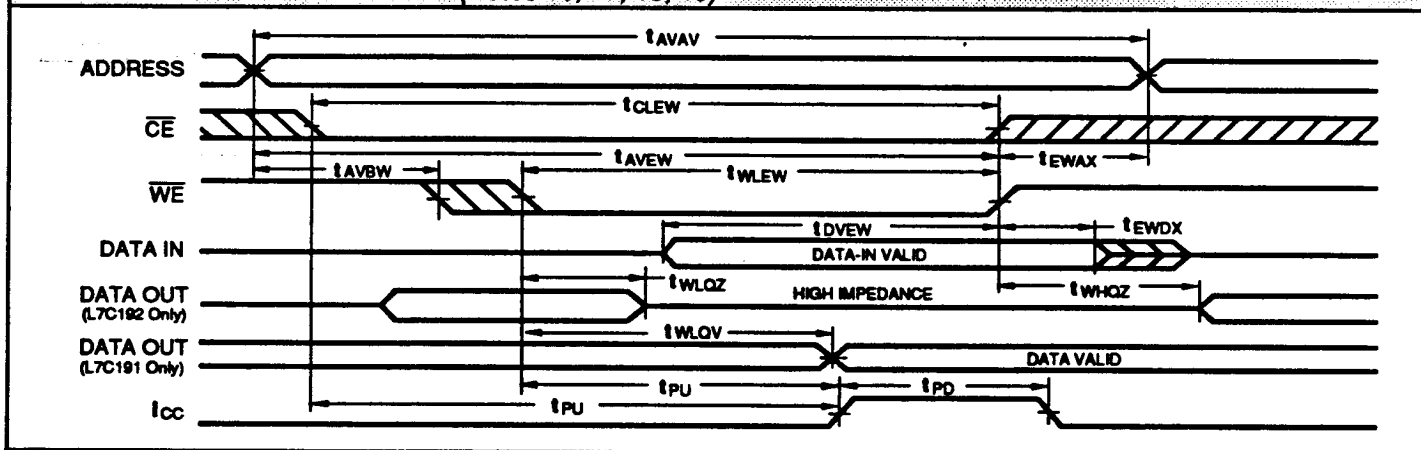

WRITE CYCLE — CE CONTROLLED (Notes 16, 17, 18, 19)

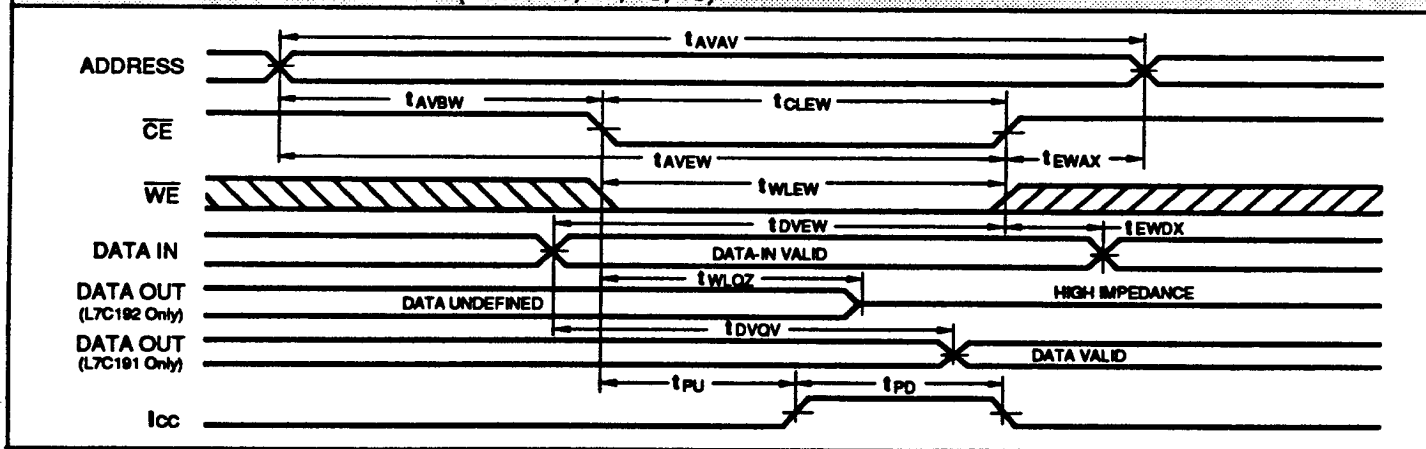

NOTES

1. Maximum Ratings indicate stress specifications only. Functional operation of these products at values beyond those indicated in the Operating Conditions table is not implied. Exposure to maximum rating conditions for extended periods may affect reliability of the tested device.
2. The products described by this specification include internal circuitry designed to protect the chip from damaging substrate injection currents and accumulations of static charge. Nevertheless, conventional precautions should be observed during storage, handling, and use of these circuits in order to avoid exposure to excessive electrical stress values.
3. This product provides hard clamping of transient undershoot. Input levels below ground will be clamped beginning at -0.6 V. A current in excess of 100 mA is required to reach -2 V. The device can withstand indefinite operation with inputs as low as -3 V subject only to power dissipation and bond wire fusing constraints.
4. Duration of the output short circuit should not exceed 30 seconds.
5. 'Typical' supply current values are not shown but may be approximated. At a VCC of $+5.0$ V, an ambient temperature of $+25^{\circ}\text{C}$ and with nominal manufacturing parameters, the operating supply currents will be approximately 3/4 or less of the maximum values shown.
6. Tested with outputs open and all address and data inputs changing at the maximum read cycle rate. The device is continuously enabled for reading, i.e., $\overline{\text{CE}} \leq \text{VIL}$, $\overline{\text{WE}} \geq \text{VIH}$. Input pulse levels are 0 to 3.0 V.
7. Tested with outputs open and all address and data inputs changing at the maximum read cycle rate. The device is continuously disabled, i.e., $\overline{\text{CE}} \geq \text{VIH}$.
8. Tested with outputs open and all address and data inputs stable. The device is continuously disabled, i.e., $\overline{\text{CE}} = \text{VCC}$. Input levels are within 0.2 V of VCC or ground.
9. Data retention operation requires that VCC never drop below 2.0 V. $\overline{\text{CE}}$ must be $\geq \text{VCC} - 0.2$ V. For all other inputs $\text{VIN} \geq \text{VCC} - 0.2$ V or $\text{VIN} \leq 0.2$ V is required to ensure full powerdown.
10. These parameters are guaranteed but not 100% tested.
11. Test conditions assume input transition times of less than 3 ns, reference levels of 1.5 V, output loading for specified IOL and

IOH plus 30 pF (Fig. 1a), and input pulse levels of 0 to 3.0 V (Fig. 2).

12. Each parameter is shown as a minimum or maximum value. Input requirements are specified from the point of view of the external system driving the chip. For example, t_{AVW} is specified as a minimum since the external system must supply at least that much time to meet the worst-case requirements of all parts. Responses from the internal circuitry are specified from the point of view of the device. Access time, for example, is specified as a maximum since worst-case operation of any device always provides data within that time.

13. $\overline{\text{WE}}$ is high for the read cycle.

14. The chip is continuously selected ($\overline{\text{CE}}$ low).

15. All address lines are valid prior-to or coincident-with the $\overline{\text{CE}}$ transition to low.

16. The internal write cycle of the memory is defined by the overlap of $\overline{\text{CE}}$ low and $\overline{\text{WE}}$ low. Both signals must be low to initiate a write. Either signal can terminate a write by going high. The address, data, and control input setup and hold times should be referenced to the signal that falls last or rises first.

17. If $\overline{\text{WE}}$ goes low before or concurrent with $\overline{\text{CE}}$ going low, the output remains in a high impedance state.

18. If $\overline{\text{CE}}$ goes high before or concurrent with $\overline{\text{WE}}$ going high, the output remains in a high impedance state.

19. Powerup from ICC2 to ICC1 occurs as a result of any of the following conditions:

- a. Falling edge of $\overline{\text{CE}}$.
- b. Falling edge of $\overline{\text{WE}}$ ($\overline{\text{CE}}$ active).
- c. Transition on any address line ($\overline{\text{CE}}$ active).
- d. Transition on any data line ($\overline{\text{CE}}$ and $\overline{\text{WE}}$ active).

The device automatically powers down from ICC2 to ICC1 after t_{PD} has elapsed from any of the prior conditions. This means that power dissipation is dependent on only cycle rate, and is not on Chip Select pulse width.

20. At any given temperature and voltage condition, output disable time is less than output enable time for any given device.

21. Transition is measured ± 200 mV from steady state voltage with specified loading in Fig. 1b. This parameter is sampled and not 100% tested.

22. All address timings are referenced from the last valid address line to the first transitioning address line.

23. $\overline{\text{CE}}$ or $\overline{\text{WE}}$ must be high during address transitions.

24. This product is a very high speed device and care must be taken during testing in order to realize valid test information. Inadequate attention to setups and procedures can cause a good part to be rejected as faulty. Long high inductance leads that cause supply bounce must be avoided by bringing the VCC and ground planes directly up to the contactor fingers. A 0.01 μF high frequency capacitor is also required between VCC and ground. To avoid signal reflections, proper terminations must be used.

FIGURE 1a.

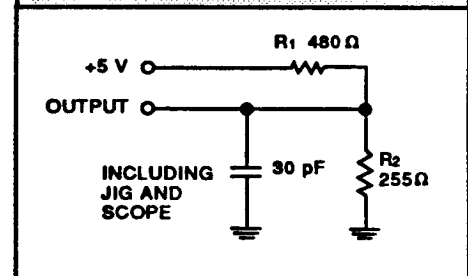

FIGURE 1b.

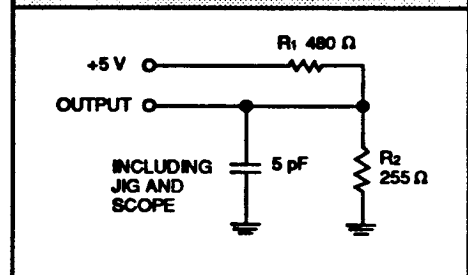
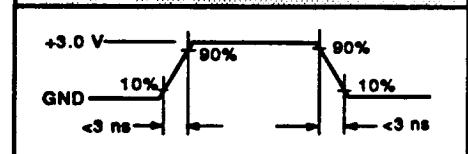
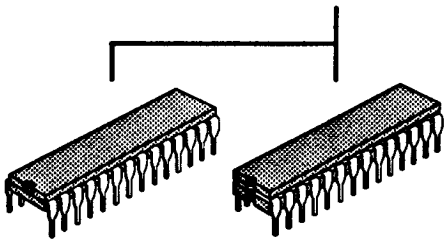
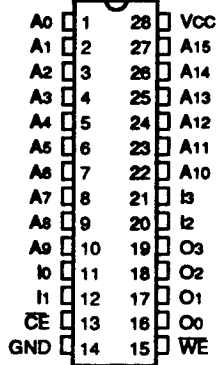

FIGURE 2.



ORDERING INFORMATION

28-pin
(0.3" wide)



28-pin

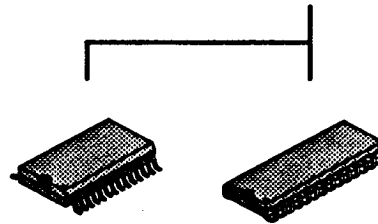
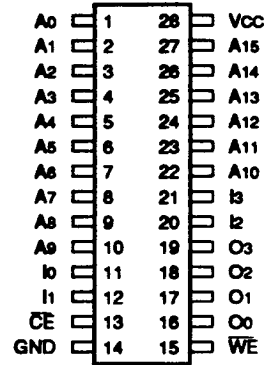

Speed	Plastic DIP (P10)	CerDIP (C5)	Plastic SOIC (.331" - V2)	Plastic SOJ (.300" - W2)
0°C to +70°C — COMMERCIAL SCREENING				
45 ns 35 ns 25 ns 20 ns 15 ns 12 ns	L7C191PC or L7C192PC	L7C191CC or L7C192CC	L7C191VC or L7C192VC	L7C191WC or L7C192WC
-55°C to +125°C — COMMERCIAL SCREENING				
45 ns 35 ns 25 ns 20 ns 15 ns 12 ns		L7C191CM or L7C192CM		
-55°C to +125°C — EXTENDED SCREENING				
45 ns 35 ns 25 ns 20 ns 15 ns 12 ns		L7C191CME or L7C192CME		
-55°C to +125°C — MIL-STD-883 COMPLIANT				
45 ns 35 ns 25 ns 20 ns 15 ns 12 ns		L7C191CMB or L7C192CMB		