

E2R-A01

Compact Low Profile Inductive Proximity Sensor with 5 mm Sensing Distance

- Non-contact sensing assures accurate detection regardless of target's color or surface texture
- Fast response time of 0.2 milliseconds (5 kHz)
- High output current of 100 mA
- Enclosure rating: IEC144 IP50
- Easy to mount package (6 mm high)

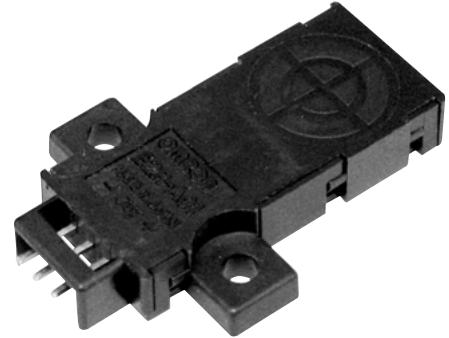

Ordering Information

■ Sensor

Sensing head	Sensing distance	Output configuration	Part number
Non-shielded 	5 mm	NPN, normally open	E2R-A01

■ Connector

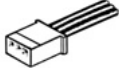
Appearance	Cable length	Part number
	1 m	E22-01

Application

Positioning a workpiece with sensor embedded in a conveyor system

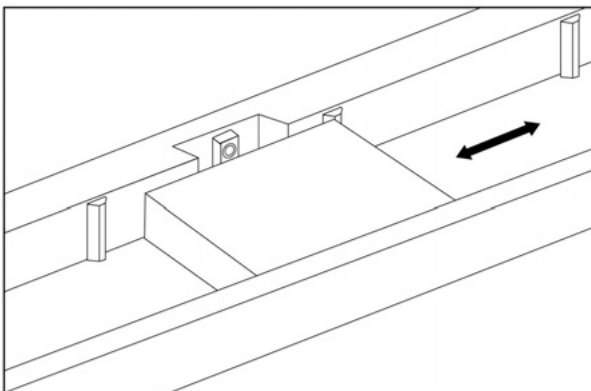

Specifications

■ Ratings/Characteristics

Supply voltage (operating voltage)	12 to 24 VDC $+15\%$ / -10% , ripple (p-p): 10% max.
Current consumption	8 mA
Detectable object	Ferrous metals (refer to "Engineering Data" for non-ferrous metals)
Sensing distance	5 mm $\pm 15\%$
Setting distance (standard object) (see note 1)	0 to 3.4 mm (iron, 18 x 18 x 1 mm)
Differential travel	10% of max. sensing distance
Response frequency (see note 2)	5 kHz min.
Operation	Output transistor ON when sensing object
Control output	NPN open collector, 100 mA max.
Indicators	Operation indicator (red LED)
Ambient temperature	Operating: -10 to 55°C (14 to 131°F) with no freezing
Ambient humidity	Operating: 35% to 85% with no condensation
Temperature influence (see note 3)	$\pm 20\%$ max of sensing distance within a temperature range of -10 to 55°C (14 to 131°F) based on the sensing distance at a temperature of 23°C (73.4°F)
Voltage influence (see note 4)	$\pm 2.5\%$ max. of sensing distance within a range of $\pm 10\%$ of rated voltage
Residual voltage	1.0 V max. (under load current of 100 mA with cable length of 1 m)
Insulation resistance	50 M Ω min. (at 500 VDC) between current carrying parts and case
Dielectric strength	1,000 VAC, 50/60 Hz for 1 minute between current carrying parts and case
Vibration resistance	Destruction: 10 to 55 Hz, 1.5 mm double amplitude for 2 hrs each in X, Y and Z directions
Shock resistance	Destruction: 500 m/s ² (approx. 50G) for 3 times each in X, Y and Z directions
Enclosure rating	IEC144 IP50
Weight	Approx. 5.5 g
Material	Sensing Surface: PBT resin Rear cover: ABS resin

- Note:**
- Refers to the distance from the detecting surface to the passing position of the detectable object which permits positive detection even when the sensing detecting surface is decreased due to temperature or voltage fluctuation.
 - The response frequencies for DC switching are average values measured on condition that the distance between each sensing object is twice as large as the size of the standard object and the sensing distance set is half of the maximum sensing distance.
 - Refers to a change in detecting distance when the ambient operating temperature changes within Omron's specified range and is expressed as the rate of variation (in percentage) with the detecting distance at the rated voltage taken as 100%.
 - Refers to a change in detecting distance when the supply voltage changes within a permissible range and is expressed as the rate of variation (in percentage) with the detecting distance at the rated voltage taken as 100%.

Engineering Data

Operating Range (Typical)

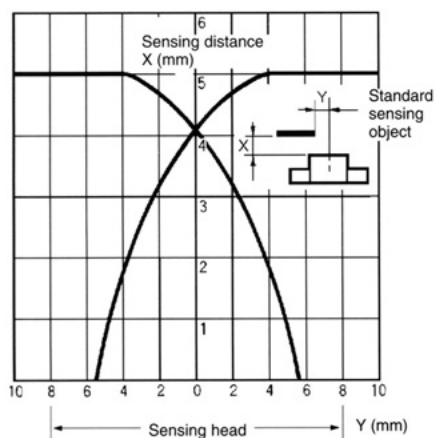

Sensing Distance vs. Sensing Object (Typical)

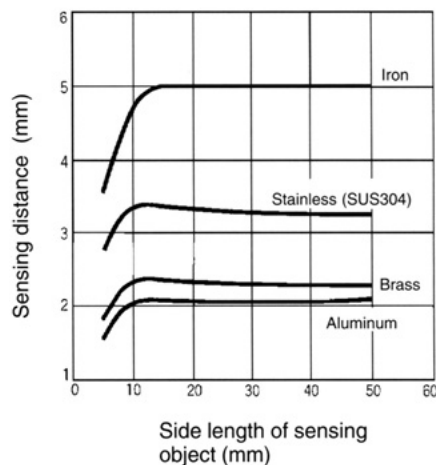

Operation

■ Output Circuit Diagram

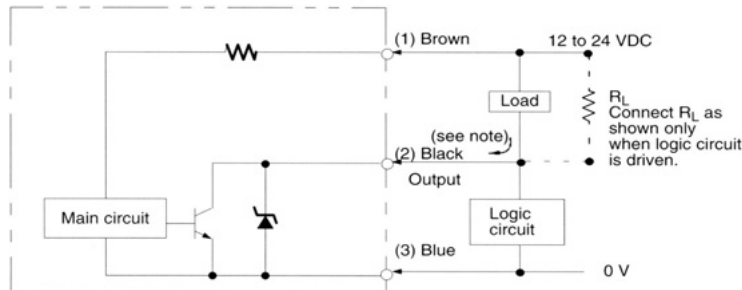

Note: Load current: 100 mA max.

■ Timing Chart

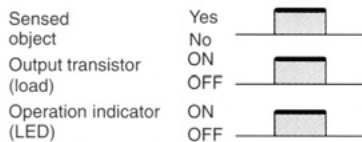

Dimensions

Unit: mm (inch)

■ E2R-A01

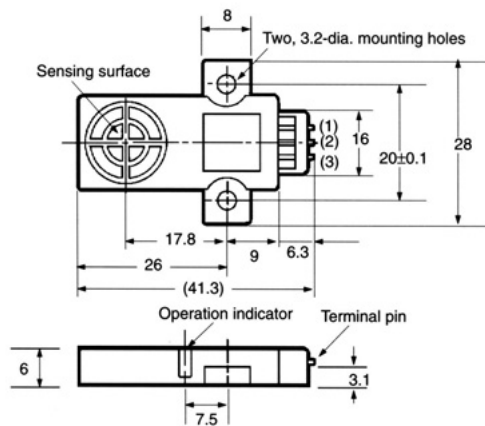
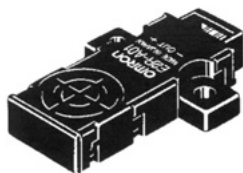

Mounting Holes

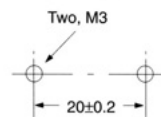

Terminal Arrangement

(1)	⊕	Power supply (+V)
(2)	OUT	Output
(3)	⊖	Power supply (0 V)

■ E22-01

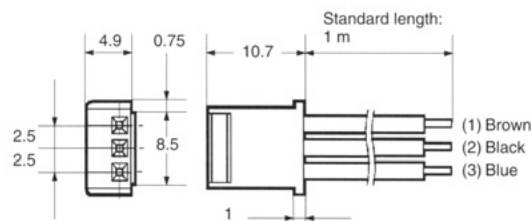
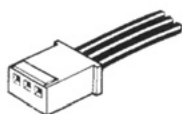

Note: Japan Molex's connector block (housing 5209-03 and terminal 5103) is used.

Precautions

Effects of Surrounding Metal

If there is any metal near the sensor, the metal may effect the performance of the E2R or the temperature of the metal may effect the sensing distance of the E2R. Make sure that the clearances given in the following illustrations are maintained for accurate sensing operation.

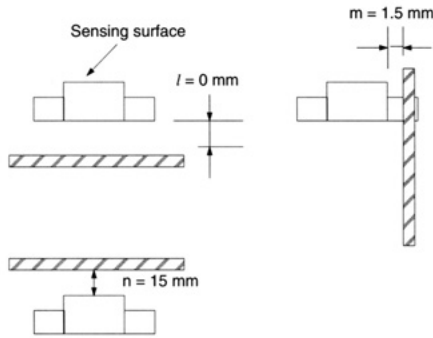

Mutual Interference

When installing two or more E2R units face to face or side by side, make sure that the minimum distances given in the following illustration is maintained.

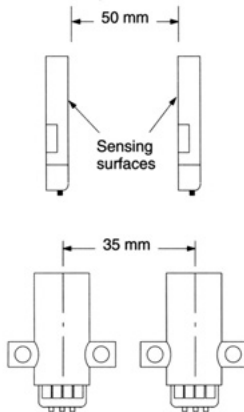

Handling and Connections

The E2R incorporates a connector. Do not solder connector pins to lead wires. Use the E22-01 Connector or Molex connector (housing 010308033 and terminal 008700057) or Japan Molex connector (housing 5209-03 and terminal 5103).

Do not impose external force on the terminal as shown in the following illustration or else the terminal may be damaged.

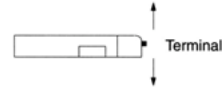

Do not connect or disconnect the connector with the E2R turned on as the E2R may be damaged.

Power Supply

When using a standard switching regulator with the E2R, ground the frame ground (FG) and ground (G) terminals of the switching regulator for stable operation.

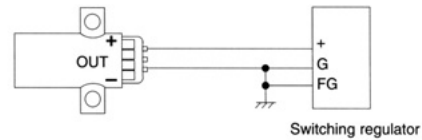

ALL DIMENSIONS SHOWN ARE IN MILLIMETERS. To convert millimeters into inches, divide by 25.4



OMRON ELECTRONICS LLC
 One East Commerce Drive
 Schaumburg, IL 60173
1-800-55-OMRON

OMRON ON-LINE
 Global - <http://www.omron.com>
 USA - <http://www.omron.com/oei>
 Canada - <http://www.omron.com/oci>

OMRON CANADA, INC.
 885 Milner Avenue
 Toronto, Ontario M1B 5V8
416-286-6465