

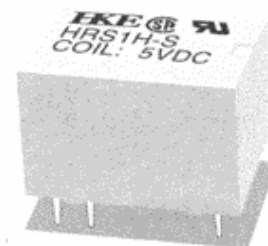

HRS1(H) Relay

1.COIL DATA

1.1 Nominal Voltage.	3 VAC t 24 VAC
1.2 Coil Resistance	refer to Table 1
1.3 Operate Voltage	refer to Table 1
1.4 Release Voltage	refer to Table 1
1.5 Nominal Power Consumption	200 to 360 mW



HRS1(H) Relay

2.CONTACT DATA

2.1 Contact Arrangement	1 Form C
2.2 Contact Material	AuAg
2.3 Contact Rating	1A 24VDC/120VAC
2.4 Max-Switching Voltage	30 VAC/120VAC
2.5 Max-Switching Current	2A
2.6 Max.switching Power	120 VA,24W
2.7 Contact Resistance (Initial)	100 mΩ at 6 VAC 1A
2.8 Life Expectancy Electrical	100,000 operation at nominal load
Mechanical	10,000,000 operations

3.GENERAL DATA

3.1 Insulation Resistance	Min. 100mΩ at 500 VDC
3.2 Dielectric Strength	1000 VAC,1 min between open contact 1,500 VAC,1 min between contact and coil.
3.3 Operate time	Max. 5 mS
3.4 Release Time	Max. 5 mS
3.5 Temperature Range	-25 to +55
3.6 Shock Resistance	10 G
3.7 Vibration Resistance	10 - 55 Hz,Amplitude 1.5mm

4.DIMENSION (in mm)

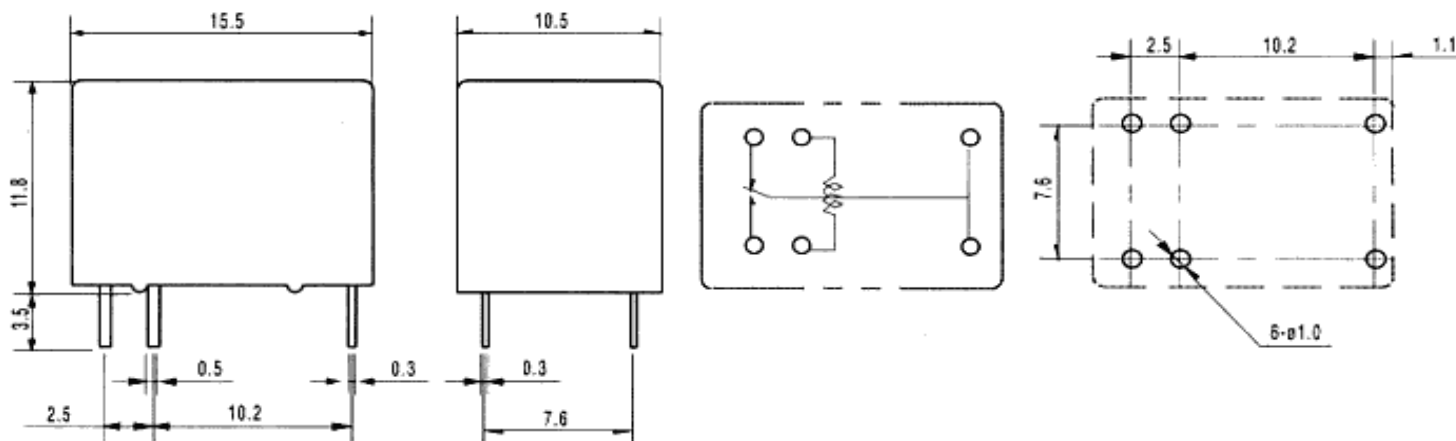

5. ORDERING CODE

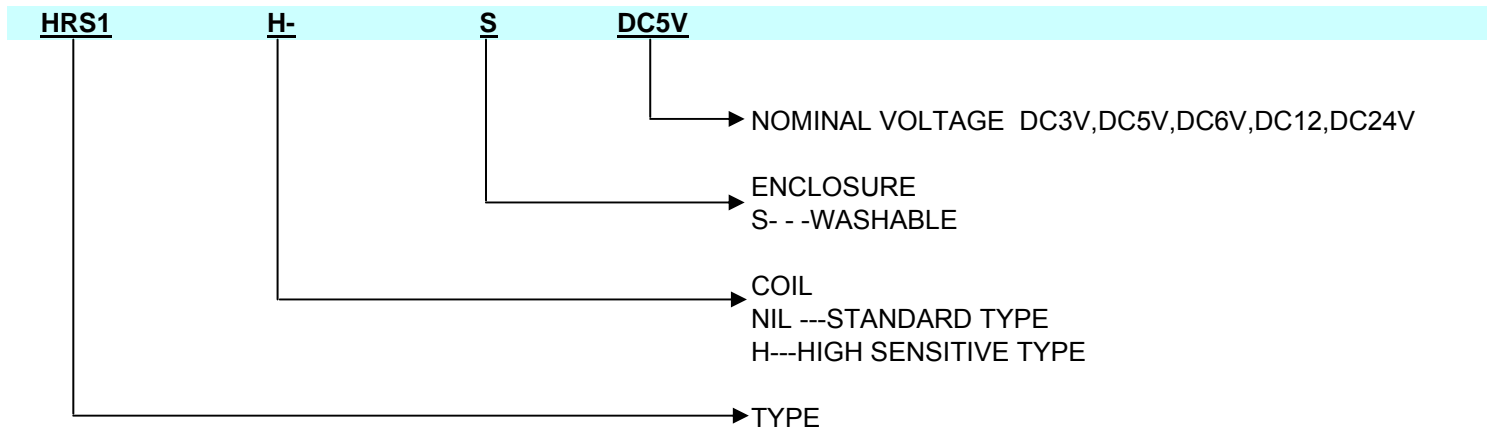

6. COIL DATA CHART

ORDERING CODE	COIL NOMINAL VDC	COIL RESISTANCE +/-10%	OPERATE VOLTAGE VDC	RELEASE VOLTAGE VDC	COIL NOMINAL mW
HRS1-S DC3V	3	25	2.25	0.30	360
HRS1-S DC5V	5	70	3.75	0.50	
HRS1-S DC6V	6	100	4.50	0.60	
HRS1-S DC9V	9	220	6.75	0.90	
HRS1-S DC12V	12	400	9.00	1.20	
HRS1-S DC24V	24	1600	18.00	2.40	
HRS1H-S DC3V	3	45	2.25	0.30	200
HRS1H-S DC5V	5	120	3.75	0.50	
HRS1H-S DC6V	6	180	4.50	0.60	
HRS1H-S DC9V	9	400	6.75	0.90	
HRS1H-S DC12V	12	700	9.00	1.20	
HRS1H-S DC24V	24	2800	18.00	2.40	

Table 1

7. HRS1(H) CHARACTERISTIC DATA

Timing

Coil Temperature

Operating Range

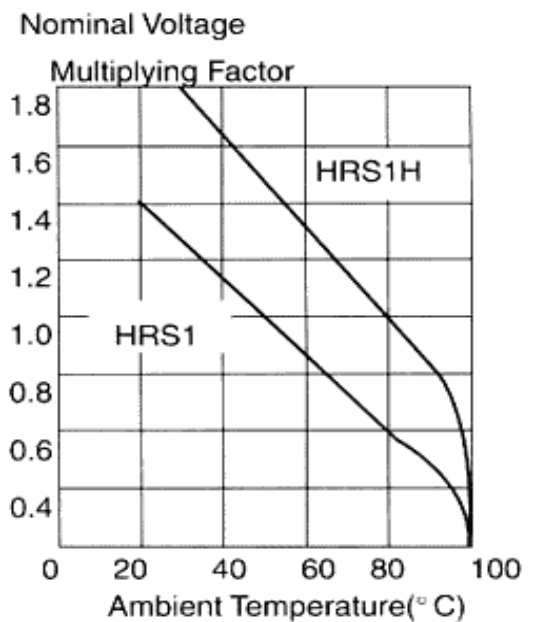
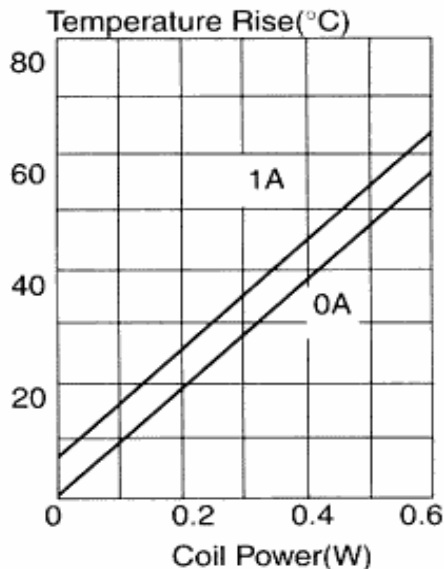
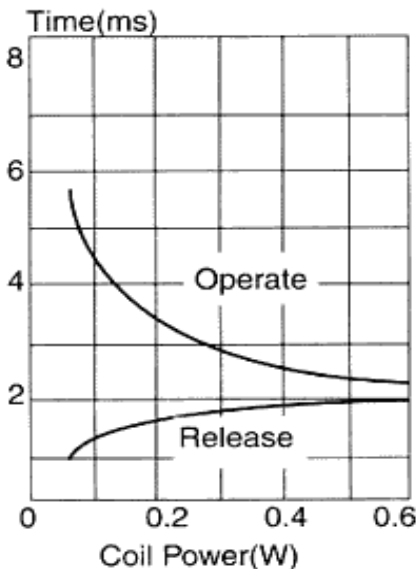

Maximum Switching Power

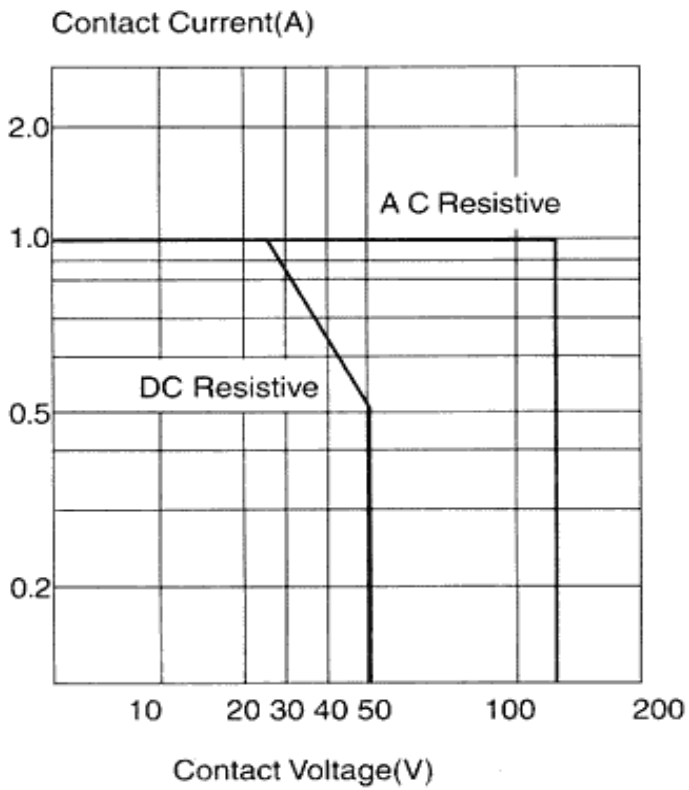

Life Curve

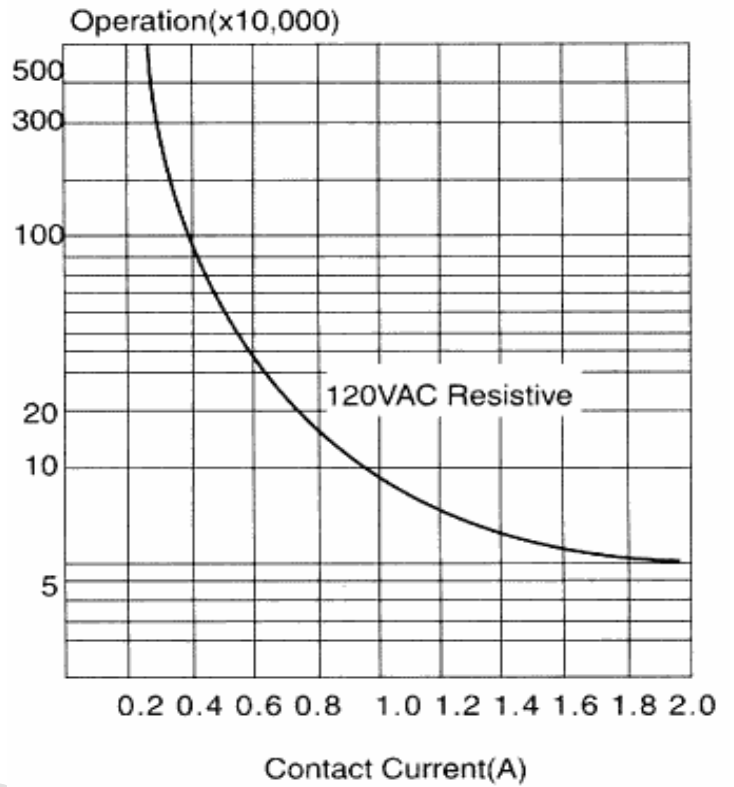

www.DataSheet4U.com