



**DATE : 15.Feb.2007**

**SAMSUNG TFT-LCD**

**MODEL : LTI570HH-L01**

The Information Described in this Specification is Preliminary and can be changed without prior notice

APPROVED BY <b>Nam Heon Kim</b>	DATE 15.Feb.2007	PREPARED BY <b>Yu Geun Lee</b>	DATE 15.Feb.2007
------------------------------------	---------------------	-----------------------------------	---------------------

Development Team 2, LCD Business

Samsung Electronics Co . , LTD.

MODEL	LTI570HH-L01	Doc. No	05-003-G-070215	Page	1 / 27
-------	--------------	---------	-----------------	------	--------

## Contents

Revision History .....	(3)
General Description .....	(4)
General Information .....	(4)
1. Absolute Maximum Ratings .....	(5)
2. Application information for I.D. (Information Display) .....	(6)
3. Optical Characteristics .....	(7)
4. Electrical Characteristics .....	(10)
4.1 TFT LCD Module	
4.2 Back Light Unit	
4.3 Inverter Input & Specification	
5. Input Terminal Pin Assignment .....	(13)
5.1 Input Signal & Power	
5.2 Inverter Input Pin Configuration	
5.3 Inverter Input Power Sequence	
5.4 LVDS Interface	
5.5 Input Signals, Basic Display Colors and Gray Scale of Each Color	
6. Interface Timing .....	(18)
6.1 Timing Parameters (DE only mode)	
6.2 Timing Diagrams of interface Signal (DE only mode)	
6.3 Power ON/OFF Sequence	
7. Outline Dimension .....	(21)
8. Packing .....	(23)
9. Marking & Others .....	(24)
10. General Precaution .....	(25)
10.1 Handling	
10.2 Storage	
10.3 Operation	
10.4 Operation Condition Guide	
10.5 Others	

MODEL

LTI570HH-L01

Doc. No

05-003-G-070215

Page

2 / 27

## \* Revision History

Date	Rev. No	Page	Summary			
Aug 09, 2006	000	all	First issued			
Aug 12, 2006	001	10	Rush current Typ	TBD 5.5A		
			Current of power supply (Typ)	Black pattern : TBD 1400mA Mosaic pattern : TBD 1650mA N-Pattern : TBD 2020mA		
		11	Lamp Voltage range	1800V ~ 2100V 1850V ~ 2050V		
		12	Inverter Input current Max	TBD 17A		
			Lamp current range	6.0mA ~ 7.0mA 5.5mA ~ 6.5mA		
			Inverter frequency range	46kHz ~ 56kHz 45kHz ~ 55kHz		
			PWM Frequency range	120Hz ~ 240Hz 120Hz ~ 180Hz		
Dec 20, 2006	002	4	Weight	30,000g 30,600g		
		7	Contrast Ratio Min	TBD 1000		
			Luminance Min	TBD 500cd/m <sup>2</sup>		
		10	Current of Power Supply	Black	1400mA 1180mA	
				White	1650mA 1150mA	
				N-Pattern	2020mA 1200mA	
			Vsync Frequency Range	TBD 50Hz ~ 62Hz		
			Hsync Frequency Range	TBD 60kHz ~ 70kHz		
			Main Frequency Range	TBD 120MHz ~ 154MHz		
			Rush Current Max	TBD 5A		
		11	Lamp Voltage range	1850V ~ 2050V 1976V ~ 2184V		
		12	Inverter Input Current Max	17A 21A		
			Internal PWM Dimming function is added			
		13	Pin #46	DCC Option No Connection		
		15	Pin #13	No Connection Internal PWM Dimming		
		18	Clock Range	TBD 120MHz ~ 154MHz		
			Hsync Range	TBD 60kHz ~ 70kHz		
			Vsync Range	TBD 50Hz ~ 62Hz		
			Vertical Total Range	TBD 1092lines ~ 1158lines		
			Horizontal Total Range	TBD 2016clocks ~ 2400clocks		
		23	Total Pallet Weight	276.5Kg 281.3Kg		
		Feb 15, 2007	003	12	Inverter frequency range	45kHz ~ 55kHz 45kHz ~ 52kHz

MODEL

LTI570HH-L01

Doc. No

05-003-G-070215

Page

3 / 27

## General Description

### Description

LTI570HH-L01. is a color active matrix liquid crystal display (LCD) that uses amorphous silicon TFT(Thin Film Transistor) as switching components. This model is composed of a TFT LCD panel, a driver circuit and a back light unit. The resolution of a 57.0" is 1920 x 1080 and this model can display up to 16.7 million colors with wide viewing angle of 89° or higher in all directions. This panel is intended to support applications to provide a excellent performance for Flat Panel Display such as Home-alone Multimedia TFT-LCD TV, Display terminals for AV application products, and Digital Information Display (DID).

### Features

- RoHS compliance (Pb-free)
- High contrast ratio, High aperture ratio, High luminance
- SPVA(Super Patterned Vertical Align) mode
- Wide viewing angle ( $\pm 178^\circ$ )
- High speed response
- WXGA (1920 x 1080 pixels) resolution (16:9)
- Low Power consumption
- Direct Type 36 CCFTs(Cold Cathode Fluorescent Tube)
- DE(Data Enable) mode
- LVDS (Low Voltage Differential Signaling) interface (2pixel/clock)

## General Information

Items	Specification	Unit	Note
Module Size	1328.0( $W_{TYP}$ ) x 764.0( $H_{TYP}$ )	mm	$\pm 1.0$ mm
	64.5( $D_{MAX}$ )		
Weight	31,100(Max.)	g	
Pixel Pitch	0.65175(H) x 0.65175(V)	mm	
Active Display Area	1251.36(H) x 703.89(V)	mm	
Surface Treatment	Haze 40% , Hard-coating (3H)		
Display Colors	8 bit - 16.7M	colors	
Number of Pixels	1920 x 1080	pixel	
Pixel Arrangement	RGB vertical stripe		
Display Mode	Normally Black		
Luminance of White	600 (Typ.)	cd/m <sup>2</sup>	

MODEL

LTI570HH-L01

Doc. No

05-003-G-070215

Page

4 / 27

## 1. Absolute Maximum Ratings

If the condition exceeds maximum ratings, it can cause malfunction or unrecoverable damage to the device.

Item	Symbol	Min.	Max.	Unit	Note
Power Supply Voltage	$V_{DD}$	GND-0.5	13.2	V	(1)
Storage temperature	$T_{STG}$	-20	60		(2)
Glass surface temperature (Operation)	Center	$T_{OPR}$	0	50	(2),(5)
	T. Uniformity	T	-	10	
Shock ( non - operating )	$S_{nop}$	-	30	G	(3)
Vibration ( non - operating )	$V_{nop}$	-	1.5	G	(4)

Note (1)  $T_a = 25 \pm 2 \text{ }^\circ\text{C}$

(2) Temperature and relative humidity range are shown in the figure below.

- 90 % RH Max. ( $T_a < 39 \text{ }^\circ\text{C}$ )
- Relative Humidity is 90% or less. ( $T_a > 39 \text{ }^\circ\text{C}$ )
- No condensation

(3) 11ms, sine wave, one time for  $\pm X, \pm Y, \pm Z$  axis

(4) 10-300 Hz, Sweep rate 10min, 30min for X,Y,Z axis

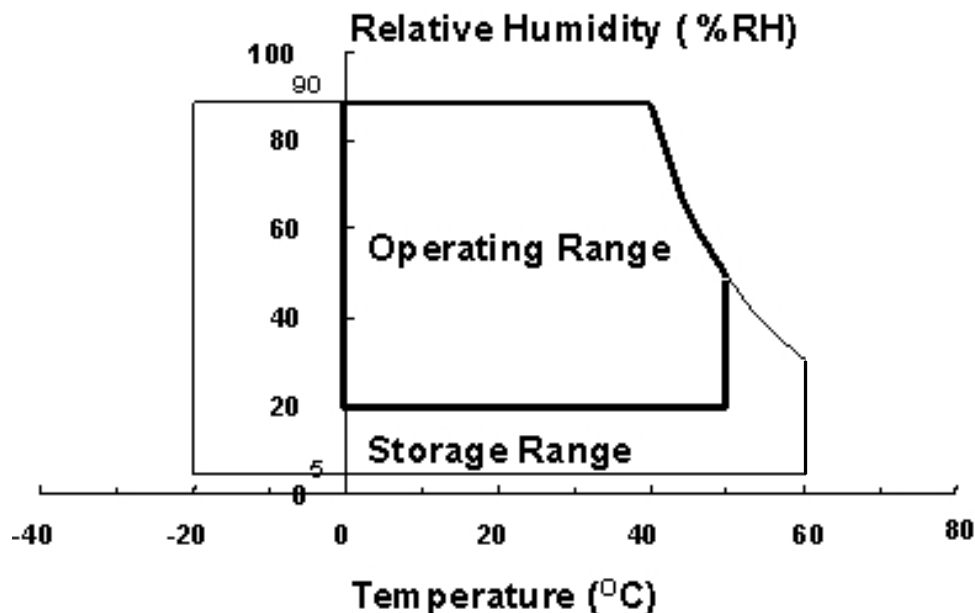
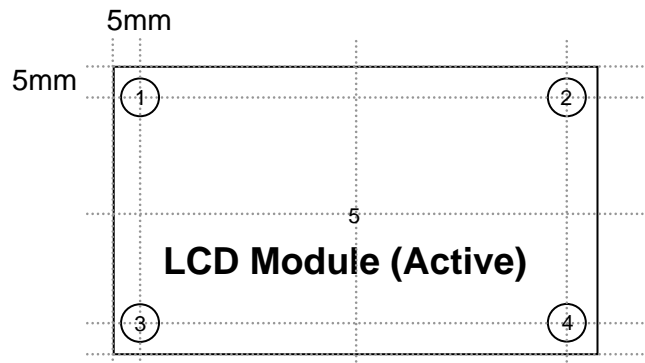

Fig. Temperature and Relative humidity range

(5) Definition of test point



$T_{OPR}$  : Temperature of the center of the glass surface (Test point 5)  
 $T1 \sim T4$  : Temperature of each edge of the glass surface  
 $T_{MAX}$  : The highest temperature of the glass surface

## 2. Application information for I.D. (Information Display)

Generally large-sized LCD modules are designed for TV applications. A long-term display like DID application can cause uneven display including image retention. To optimize module's lifetime and function, several operating usages are required.

1. Normal operating condition

- Temperature:  $20 \pm 15$
- Humidity:  $65 \pm 20 \%$
- Display pattern: moving picture

Note) Long-term static information image can cause uneven display.

2. Operating usages under abnormal operating condition. Note (1)

- Ambient condition
  - Well-ventilated place is recommended to set up I.D. system.
- Power off and screen saver
  - Periodical power-off or screen saver is needed after long-term static display. Note (2)

3. Operating usages to protect uneven display due to long-term static information display

- Suitable operating time: under 18 hours a day.
- Static information display is recommended to use moving picture periodically.
  - Change display to moving picture for 10 seconds after 5 minutes static information display.
- Background and character (image) color change
  - Use different colors for background and character (image), respectively.
  - Change colors periodically.
- Avoid combination of background and character with large different luminance.

Note (1) Abnormal condition means every operating condition except normal operating condition.

Note (2) Moving picture or black pattern is strongly recommended for screen saver.

4. Lifetime in this spec is guaranteed only when I.D. is used under operating usages.

MODEL	LTI570HH-L01	Doc. No	05-003-G-070215	Page	6 / 27
-------	--------------	---------	-----------------	------	--------

### 3. Optical Characteristics

The optical characteristics should be measured in a dark room or equivalent.

Measuring equipment : TOPCON BM-7,SPECTRORADIOMETER SR-3

(Ta = 25 ± 2°C, VDD = 12V, fv = 60Hz, f<sub>DCLK</sub> = 148.5MHz, I<sub>L</sub> = 6.0mArms)

Item	Symbol	Condition	Min.	Typ.	Max.	Unit	Note	
Contrast Ratio (Center of screen)	C/R	Normal $\theta_{L,R}=0$ $\theta_{U,D}=0$  Viewing Angle	1000	1200	-		(3) SR-3	
Response Time	Rising		Tr	-	3.5	10	msec	(5) BM-7
	Falling		Tf	-	4.5	10		
	G-to-G		Tg	-	8	-		
Luminance of White (Center of screen)	Y <sub>L</sub>			500	600	-	cd/m <sup>2</sup>	(6) SR-3
Color Chromaticity (CIE 1931)	Red		Rx	TYP. -0.03	0.648	TYP. +0.03		(7),(8) SR-3
			Ry		0.333			
	Green		Gx		0.271			
			Gy		0.592			
	Blue		Bx		0.141			
		By	0.066					
	White	Wx	0.280					
		Wy	0.290					
Color Gamut	-		-	72	-	%	(7) SR-3	
Color Temperature	-		-	10,000	-	K	(7) SR-3	
Viewing Angle	Hor.	$\theta_L$	C/R 10	75	89	-	Degree	(8) SR-3
		$\theta_R$		75	89	-		
	Ver.	$\theta_U$		75	89	-		
		$\theta_D$		75	89	-		
Brightness Uniformity (9 Points)	B <sub>uni</sub>		-	-	25	%	(4) SR-3	

#### Note (1) Test Equipment Setup

The measurement should be executed in a stable, windless and dark room between 40min and 60min after lighting the back light at the given temperature for stabilization of the back light. This should be measured in the center of screen.

Single lamp current : 6.0mA

Environment condition : Ta = 25 ± 2 °C

MODEL

LTI570HH-L01

Doc. No

05-003-G-070215

Page

7 / 27

Photo detector	Field
SR-3	1 °
BM-7	2 °

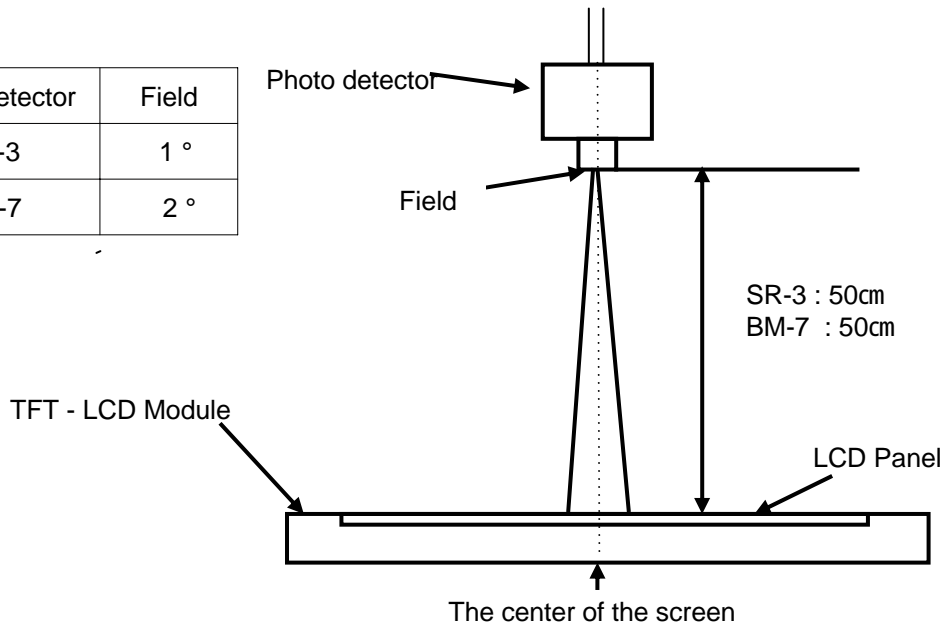

Note (2) Definition of test point

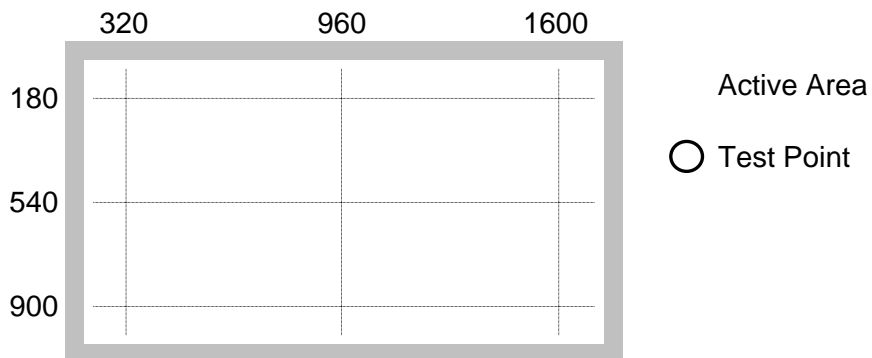

Note (3) Definition of Contrast Ratio (C/R)

: Ratio of gray max (Gmax) & gray min (Gmin) at the center point of the panel

$$C/R = \frac{G_{\max}}{G_{\min}}$$

Gmax : Luminance with all pixels white

Gmin : Luminance with all pixels black

MODEL

LTI570HH-L01

Doc. No

05-003-G-070215

Page

8 / 27



Note (4) Definition of 9 points brightness uniformity

$$B_{uni} = 100 * \frac{(B_{max} - B_{min})}{B_{max}}$$

Bmax : Maximum brightness

Bmin : Minimum brightness

Note (5) Definition of Response time : Sum of Tr, Tf

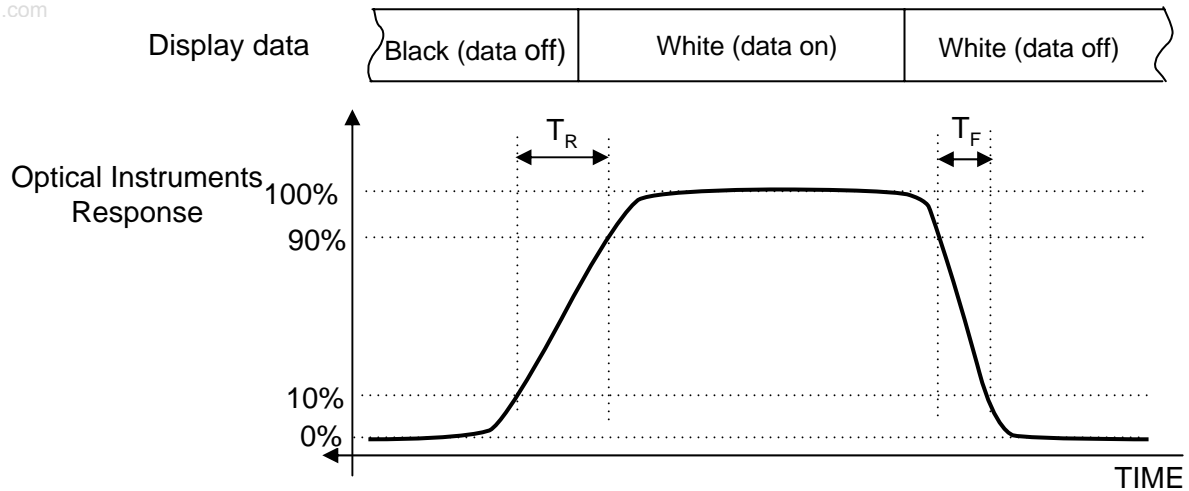

Note (6) Definition of Luminance of White : Luminance of white at center point

Note (7) Definition of Color Chromaticity (CIE 1931)

Color coordinate of Red, Green, Blue & White at center point

Note (8) Definition of Viewing Angle

: Viewing angle range (C/R 10)

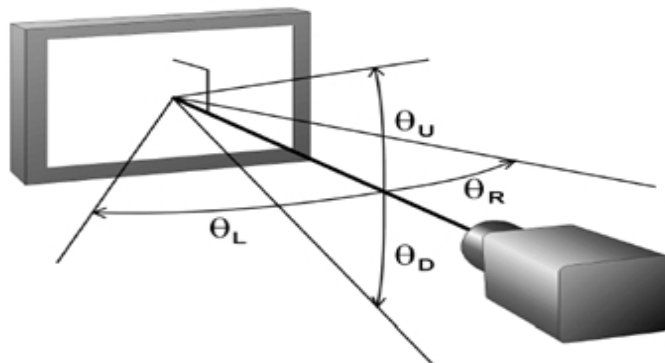

## 4. Electrical Characteristics

### 4.1 TFT LCD Module

The connector for display data & timing signal should be connected.

$T_a = 25^\circ\text{C} \pm 2^\circ\text{C}$

Item	Symbol	Min.	Typ.	Max.	Unit	Note
Voltage of Power Supply	$V_{DD}$	10.8	12.0	13.2	V	(1)
Current of Power Supply	(a) Black	-	-	1180	mA	(2),(3)
	(b) White	-	-	1150	mA	
	(c) N-Pattern	-	-	1200	mA	
Vsync Frequency	$f_V$	50	60	62	Hz	
Hsync Frequency	$f_H$	60.0	67.5	70.0	kHz	
Main Frequency	$f_{DCLK}$	120.0	148.5	154.0	MHz	
Rush Current	$I_{RUSH}$	-	-	5	A	(4)

Note (1) The ripple voltage should be controlled under 10% of  $V_{DD}$ .

(2)  $f_V = 60\text{Hz}$ ,  $f_{DCLK} = 148.5\text{MHz}$ ,  $V_{DD} = 12.0\text{V}$ , DC Current.

(3) Power dissipation check pattern (LCD Module only)

a) Black Pattern



b) White Pattern



c) N-Pattern

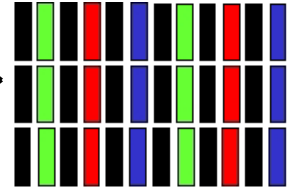
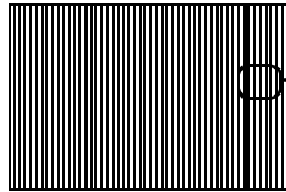

(4) Measurement Conditions

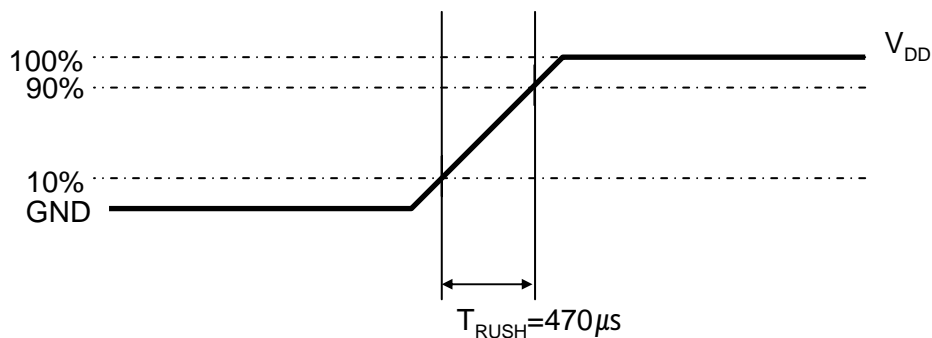

Rush Current  $I_{RUSH}$  can be measured when  $T_{RUSH}$  is  $470\mu\text{s}$ .

MODEL

LTI570HH-L01

Doc. No

05-003-G-070215

Page

10 / 27

## 4.2 Back Light Unit

The back light unit contains 36 direct-lighting type CCFTs (Cold Cathode Fluorescent Tube). The characteristics of lamps are shown in the following tables.

$T_a = 25 \pm 2^\circ\text{C}$

Item	Symbol	Min.	Typ.	Max.	Unit	Note
Lamp Current	$I_L$	4.0	5.5	7.0	mArms	
Lamp Voltage	$V_L$	1976	2080	2184	Vrms	
Operating Life Time	Hr	50,000	-	-	Hour	(1)

Note (1) It is defined as the time to take until the brightness reduces to 50% of its original value.

[Operating condition :  $T_a = 25 \pm 2$  ,  $I_L = 5.5\text{mArms}$ , For single lamp only]

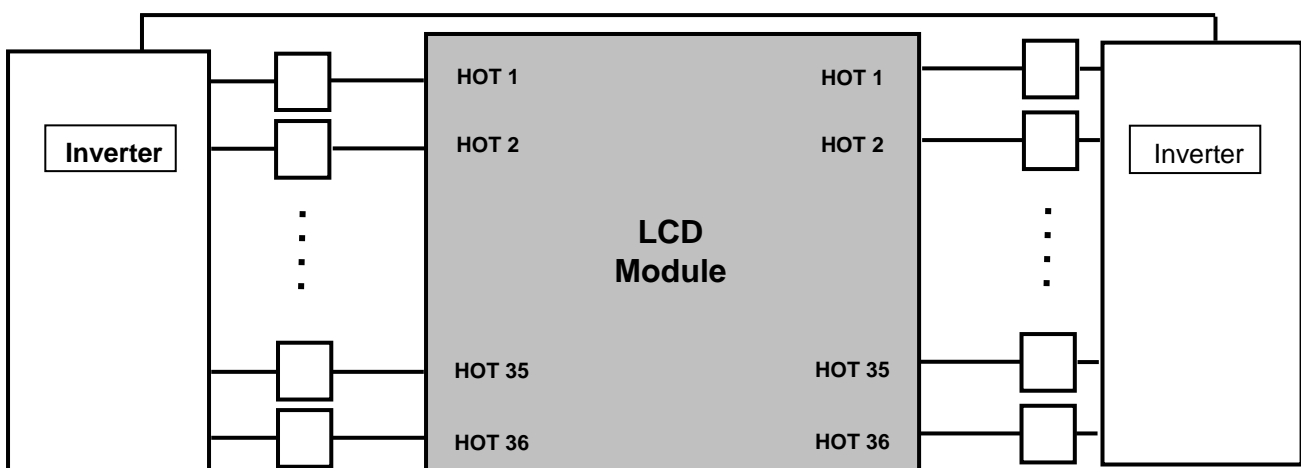

### 4.3 Inverter Input Condition & Specification

Items	Symbol	Conditions	Specifications			Unit	Note
			Min.	Typ.	Max.		
Input Voltage	V <sub>in</sub>	-	22	24	26	V	T <sub>a</sub> =25±2 °C
Input Current	I <sub>in</sub>	V <sub>in</sub> = 24.0V V <sub>dim</sub> = 3.3V	-	-	21	A	After 1 hour Warm-up @ V <sub>in</sub> =24V
Lamp Current	I <sub>O,MAX</sub>	V <sub>dim</sub> = 3.3V	5.5	6.0	6.5	mArms	
Frequency	F <sub>LAMP</sub>	V <sub>in</sub> = 24.0V V <sub>dim</sub> = 3.3V	45	49	52	kHz	
Backlight On/Off	On	V <sub>in</sub> = 24.0V	2.4	-	5.5	V	-
	Off		0	-	0.8		
PWM Frequency	F <sub>pwm</sub>	V <sub>in</sub> = 24.0V	120	150	180	Hz	-
External PWM Dimming	-	V <sub>in</sub> = 24.0V	30	-	100	%	(2)
Internal PWM Dimming	-	V <sub>in</sub> = 24.0V	0	-	3.3	V	(3)

Note (1) Power Consumption is measured at 600[cd/m<sup>2</sup>] of luminance condition which is the typical luminance value. Lamp Current is measured at the point before Lamp.

Note (2) High-duty = On/(On+Off) \* 100

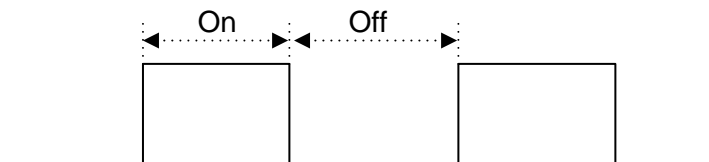

(3) Internal PWM Dimming

- Analog DC Voltage 0 V : Minimum Duty
- Analog DC Voltage 3.3 V : Maximum Duty (100%)

MODEL	LTI570HH-L01	Doc. No	05-003-G-070215	Page	12 / 27
-------	--------------	---------	-----------------	------	---------

## 5. Input Terminal Pin Assignment

### 5.1 Input Signal & Power

Connector : FI-RE51S-HF (JAE)

PIN No.	Description		PIN No.	Description
1	Vdd (12V)		26	Even LVDS Signal
2	Vdd (12V)		27	
3	Vdd (12V)		28	
4	Vdd (12V)		29	
5	Vdd (12V)		30	
6	GND		31	
7	GND		32	
8	GND		33	
9	GND		34	
10	Odd LVDS Signal	RO[0]N	35	
11		RO[0]P	36	RE[1]N
12		RO[1]N	37	RE[1]P
13		RO[1]P	38	RE[2]N
14		RO[2]N	39	RE[2]P
15		RO[2]P	40	GND
16		GND	41	RECLK-
17		ROCLK-	42	RECLK+
18		ROCLK+	43	GND
19		GND	44	RE[3]N
20		RO[3]N	45	RE[3]P
21	RO[3]P	46	No Connection	
22	No Connection		47	No Connection
23	No Connection		48	No Connection
24	GND		49	No Connection
25	Even LVDS	RE[0]N	50	No Connection
			51	No Connection

Note(1) No Connection :These pins are only used for SAMSUNG internal purpose.

MODEL

LTI570HH-L01

Doc. No

05-003-G-070215

Page

13 / 27

Note (2) Pin number starts from Right side

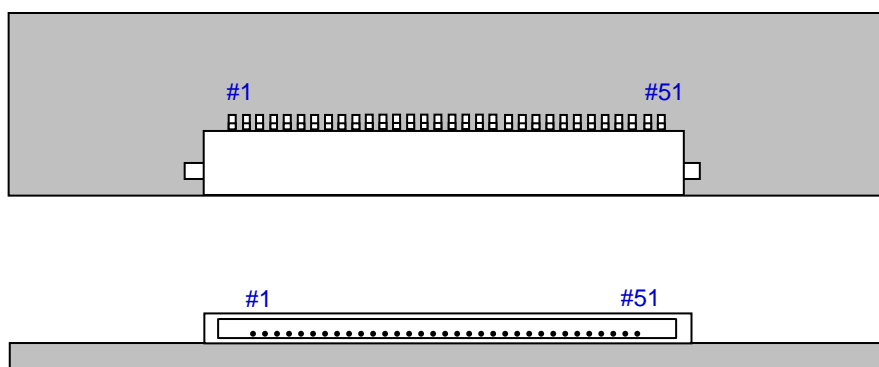
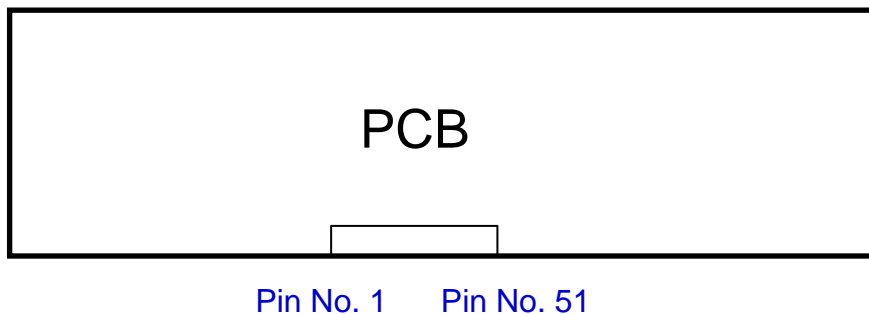

**Fig. Connector diagram**

- a. All GND pins should be connected together and also be connected to the LCD's metal chassis.
- b. All power input pins should be connected together.
- c. All N.C pins should be separated from other signal or power.

MODEL	LTI570HH-L01	Doc. No	05-003-G-070215	Page	14 / 27
-------	--------------	---------	-----------------	------	---------

## 5.2 Inverter Input Pin Configuration

Connector : JST, S14B-PHA-SM-TB(LF)

Pin No.	Pin Configuration(FUNCTION)
1	Vin (24V)
2	Vin (24V)
3	Vin (24V)
4	Vin (24V)
5	Vin (24V)
6	GND
7	GND
8	GND
9	GND
10	GND
11	No Connection
12	Backlight On /Off [On: 2.4 ~ 5.5 V, Off: 0 ~ 0.8 V]
13	Internal PWM Dimming [0V:Min, 3.3V:Max]
14	External PWM Dimming [30%:Min, 100%:Max]

Note) External PWM Dimming → Pin 13 : 3.3V or Open, Pin 14 : External PWM Pulse  
 Internal PWM Dimming → Pin 13 : DC Voltage, Pin 14 :Open

## 5.3 Inverter Input Power Sequence

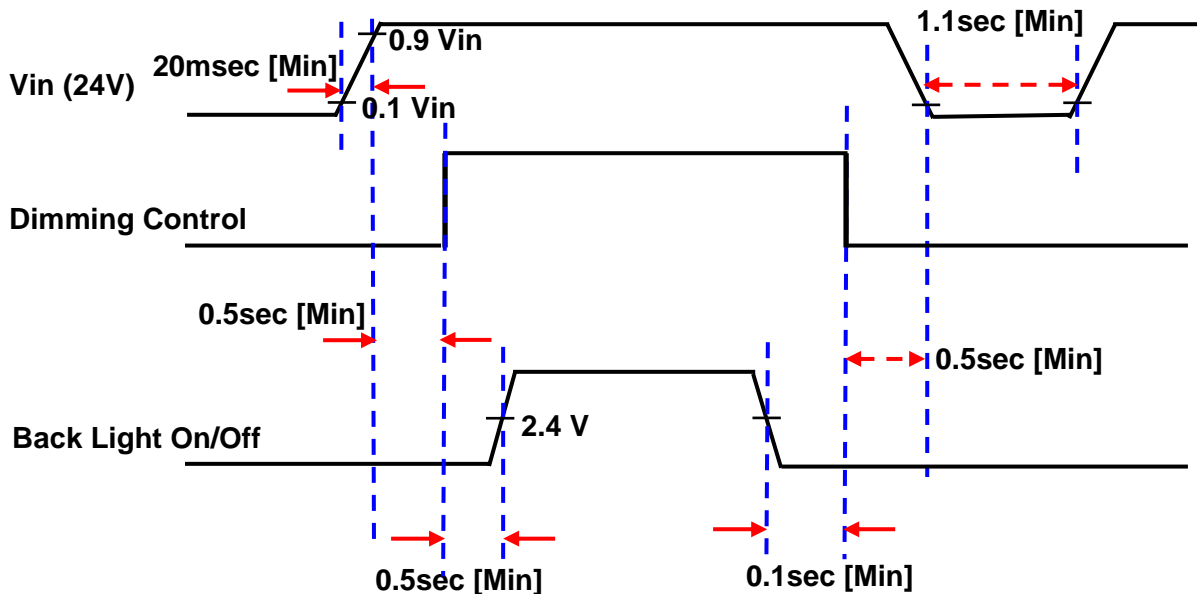

MODEL

LTI570HH-L01

Doc. No

05-003-G-070215

Page

15 / 27

### 5.4 LVDS Interface

- LVDS Receiver : Tcon (merged)
- Data Format (JEIDA & Normal)

Default LVDS Option : VESA

	LVDS pin	JEIDA -DATA	VESA -DATA
TxOUT/RxIN0	TxIN/RxOUT0	R2	R0
	TxIN/RxOUT1	R3	R1
	TxIN/RxOUT2	R4	R2
	TxIN/RxOUT3	R5	R3
	TxIN/RxOUT4	R6	R4
	TxIN/RxOUT6	R7	R5
	TxIN/RxOUT7	G2	G0
TxOUT/RxIN1	TxIN/RxOUT8	G3	G1
	TxIN/RxOUT9	G4	G2
	TxIN/RxOUT12	G5	G3
	TxIN/RxOUT13	G6	G4
	TxIN/RxOUT14	G7	G5
	TxIN/RxOUT15	B2	B0
	TxIN/RxOUT18	B3	B1
TxOUT/RxIN2	TxIN/RxOUT19	B4	B2
	TxIN/RxOUT20	B5	B3
	TxIN/RxOUT21	B6	B4
	TxIN/RxOUT22	B7	B5
	TxIN/RxOUT24	HSYNC	HSYNC
	TxIN/RxOUT25	VSYNC	VSYNC
	TxIN/RxOUT26	DEN	DEN
TxOUT/RxIN3	TxIN/RxOUT27	R0	R6
	TxIN/RxOUT5	R1	R7
	TxIN/RxOUT10	G0	G6
	TxIN/RxOUT11	G1	G7
	TxIN/RxOUT16	B0	B6
	TxIN/RxOUT17	B1	B7
	TxIN/RxOUT23	RESERVED	RESERVED

MODEL	LTI570HH-L01	Doc. No	05-003-G-070215	Page	16 / 27
-------	--------------	---------	-----------------	------	---------



### 5.5 Input Signals, Basic Display Colors and Gray Scale of Each Color

COLOR	DISPLAY (8bit)	DATA SIGNAL																								GRAY SCALE LEVEL
		RED								GREEN								BLUE								
		R0	R1	R2	R3	R4	R5	R6	R7	G0	G1	G2	G3	G4	G5	G6	G7	B0	B1	B2	B3	B4	B5	B6	B7	
BASIC COLOR	BLACK	0	0	0	0	0	0	0	0	0	0	0	0	0	0	0	0	0	0	0	0	0	0	0	0	-
	BLUE	0	0	0	0	0	0	0	0	0	0	0	0	0	0	0	0	1	1	1	1	1	1	1	1	-
	GREEN	0	0	0	0	0	0	0	0	1	1	1	1	1	1	1	1	0	0	0	0	0	0	0	0	-
	CYAN	0	0	0	0	0	0	0	0	1	1	1	1	1	1	1	1	1	1	1	1	1	1	1	1	-
	RED	1	1	1	1	1	1	1	1	0	0	0	0	0	0	0	0	0	0	0	0	0	0	0	0	-
	MAGENTA	1	1	1	1	1	1	1	1	0	0	0	0	0	0	0	0	1	1	1	1	1	1	1	1	-
	YELLOW	1	1	1	1	1	1	1	1	1	1	1	1	1	1	1	1	0	0	0	0	0	0	0	0	-
	WHITE	1	1	1	1	1	1	1	1	1	1	1	1	1	1	1	1	1	1	1	1	1	1	1	1	-
GRAY SCALE OF RED	BLACK	0	0	0	0	0	0	0	0	0	0	0	0	0	0	0	0	0	0	0	0	0	0	0	R0	
	DARK	1	0	0	0	0	0	0	0	0	0	0	0	0	0	0	0	0	0	0	0	0	0	0	R1	
		0	1	0	0	0	0	0	0	0	0	0	0	0	0	0	0	0	0	0	0	0	0	0	R2	
		:	:	:	:	:	:	:	:	:	:	:	:	:	:	:	:	:	:	:	:	:	:	:	R3~R252	
		:	:	:	:	:	:	:	:	:	:	:	:	:	:	:	:	:	:	:	:	:	:	:		
	LIGHT	1	0	1	1	1	1	1	1	0	0	0	0	0	0	0	0	0	0	0	0	0	0	0	R253	
		0	1	1	1	1	1	1	1	0	0	0	0	0	0	0	0	0	0	0	0	0	0	0	R254	
	RED	1	1	1	1	1	1	1	1	0	0	0	0	0	0	0	0	0	0	0	0	0	0	0	R255	
GRAY SCALE OF GREEN	BLACK	0	0	0	0	0	0	0	0	0	0	0	0	0	0	0	0	0	0	0	0	0	0	0	G0	
	DARK	0	0	0	0	0	0	0	0	1	0	0	0	0	0	0	0	0	0	0	0	0	0	0	G1	
		0	0	0	0	0	0	0	0	0	1	0	0	0	0	0	0	0	0	0	0	0	0	0	G2	
		:	:	:	:	:	:	:	:	:	:	:	:	:	:	:	:	:	:	:	:	:	:	:	G3~G252	
		:	:	:	:	:	:	:	:	:	:	:	:	:	:	:	:	:	:	:	:	:	:	:		
	LIGHT	0	0	0	0	0	0	0	0	1	0	1	1	1	1	1	1	0	0	0	0	0	0	0	G253	
		0	0	0	0	0	0	0	0	0	1	1	1	1	1	1	1	0	0	0	0	0	0	0	G254	
	GREEN	0	0	0	0	0	0	0	0	1	1	1	1	1	1	1	1	0	0	0	0	0	0	0	G255	
GRAY SCALE OF BLUE	BLACK	0	0	0	0	0	0	0	0	0	0	0	0	0	0	0	0	0	0	0	0	0	0	0	B0	
	DARK	0	0	0	0	0	0	0	0	0	0	0	0	0	0	0	0	1	0	0	0	0	0	0	B1	
		0	0	0	0	0	0	0	0	0	0	0	0	0	0	0	0	0	1	0	0	0	0	0	B2	
		:	:	:	:	:	:	:	:	:	:	:	:	:	:	:	:	:	:	:	:	:	:	:	B3~B252	
		:	:	:	:	:	:	:	:	:	:	:	:	:	:	:	:	:	:	:	:	:	:	:		
	LIGHT	0	0	0	0	0	0	0	0	0	0	0	0	0	0	0	0	1	0	1	1	1	1	1	B253	
		0	0	0	0	0	0	0	0	0	0	0	0	0	0	0	0	0	1	1	1	1	1	1	B254	
	BLUE	0	0	0	0	0	0	0	0	0	0	0	0	0	0	0	0	1	1	1	1	1	1	1	B255	

Note) Definition of Gray :  
 Rn : Red Gray, Gn : Green Gray, Bn : Blue Gray (n = Gray level)  
 Input Signal : 0 = Low level voltage, 1 = High level voltage

## 6. Interface Timing

### 6.1 Timing Parameters (DE only mode)

Signal	Item	Symbol	Min.	Typ.	Max.	Unit	Note
Clock	Frequency	$1/T_C$	120.0	148.5	154.0	MHz	-
Hsync		$F_H$	60.0	67.5	70.0	KHz	-
Vsync		$F_V$	50	60	62	Hz	-
Vertical Display Term	Active Display Period	$T_{VD}$	-	1080	-	Lines	-
	Vertical Total	$T_V$	1092	1125	1158	Lines	-
Horizontal Display Term	Active Display Period	$T_{HD}$	-	1920	-	Clocks	-
	Horizontal Total	$T_H$	2016	2200	2400	Clocks	-

Note) This product is DE only mode. The input of Hsync & Vsync signal does not have an effect on normal operation.

Test Point : TTL control signal and CLK at LVDS Tx input terminal in system

MODEL	LTI570HH-L01	Doc. No	05-003-G-070215	Page	18 / 27
-------	--------------	---------	-----------------	------	---------

## 6.2 Timing diagrams of interface signal (DE only mode)

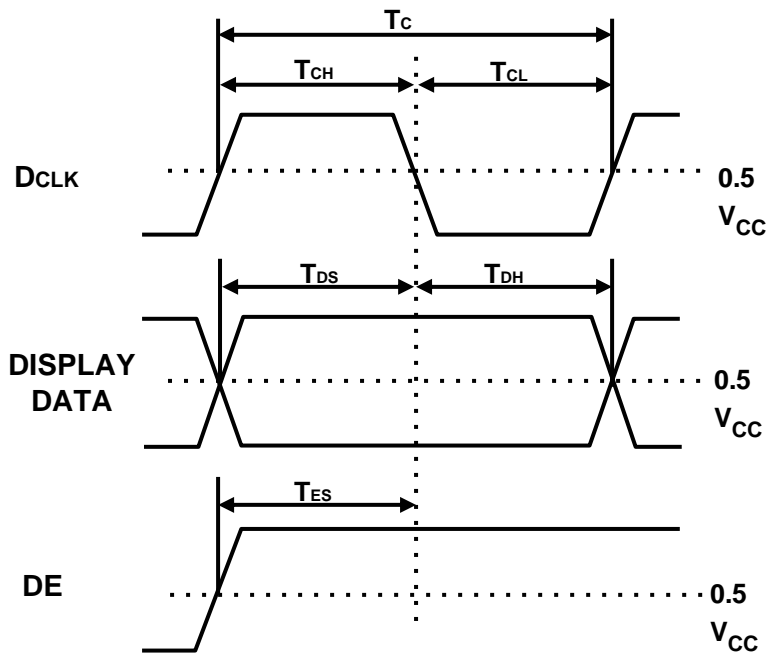
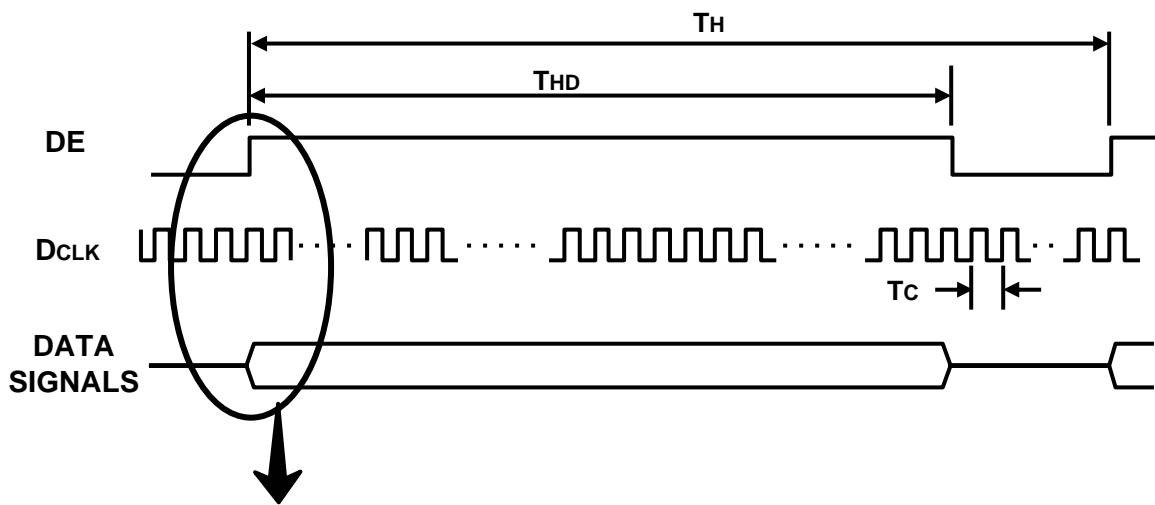
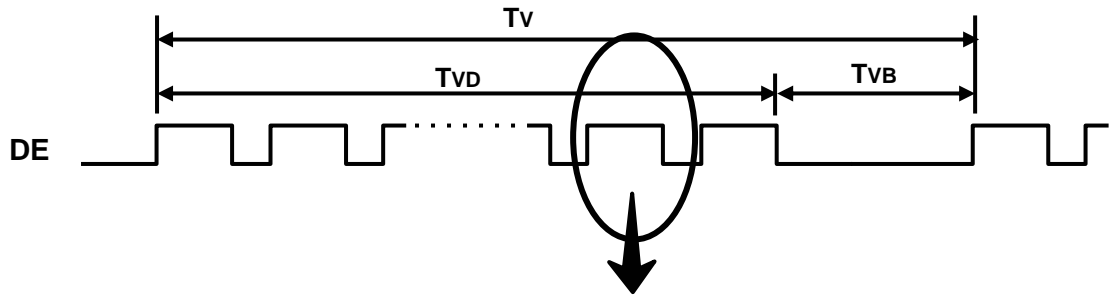

MODEL	LTI570HH-L01	Doc. No	05-003-G-070215	Page	19 / 27
-------	--------------	---------	-----------------	------	---------

### 6.3 Power ON/OFF Sequence

To prevent a latch-up or DC operation of the LCD Module, the power on/off sequence should be as the diagram below.

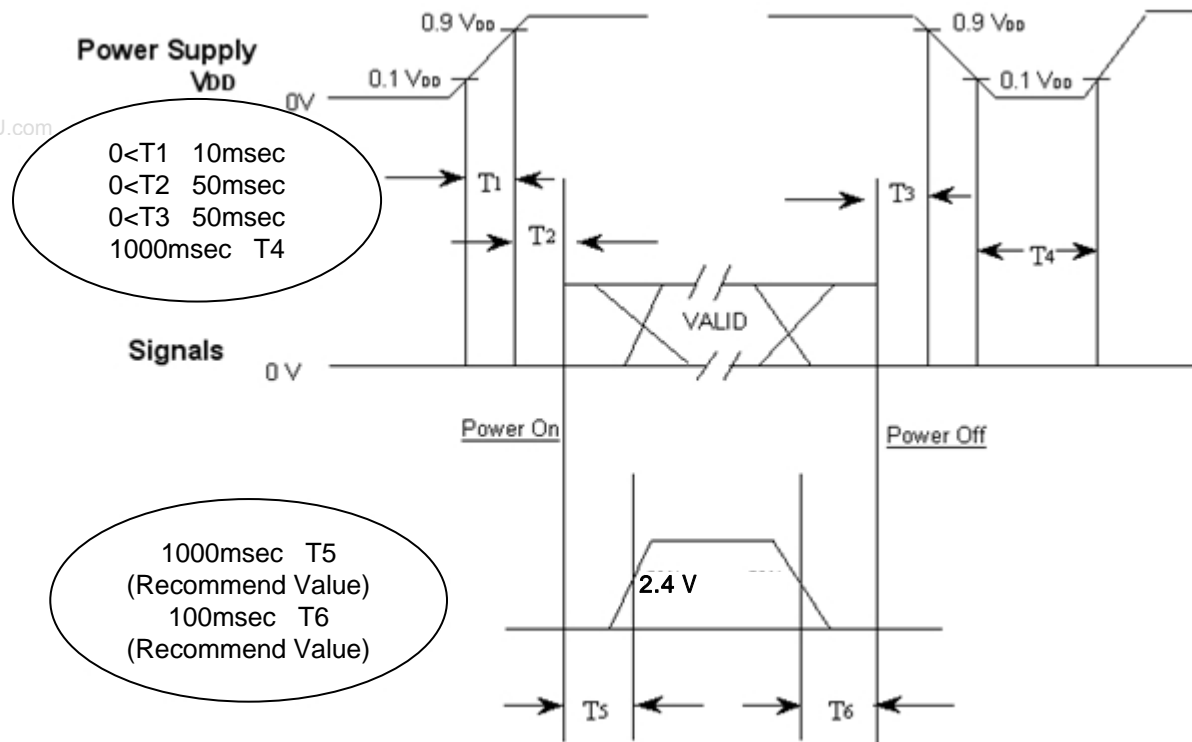

- T1 : V<sub>DD</sub> rising time from 10% to 90%
- T2 : The time from V<sub>DD</sub> to valid data at power ON.
- T3 : The time from valid data off to V<sub>DD</sub> off at power Off.
- T4 : V<sub>DD</sub> off time for Windows restart
- T5 : The time from valid data to B/L enable at power ON.
- T6 : The time from valid data off to B/L disable at power Off.

- The supply voltage of the external system for the Module input should be the same as the definition of V<sub>DD</sub>.
- Apply the lamp voltage within the LCD operation range. When the back light turns on before the LCD operation or the LCD turns off before the back light turns off, the display may momentarily show abnormal screen.
- In case of V<sub>DD</sub> = off level, please keep the level of input signals low or keep a high impedance.
- T4 should be measured after the Module has been fully discharged between power off and on period.
- Interface signal should not be kept at high impedance when the power is on.

# 7. Outline Dimension (Front View)

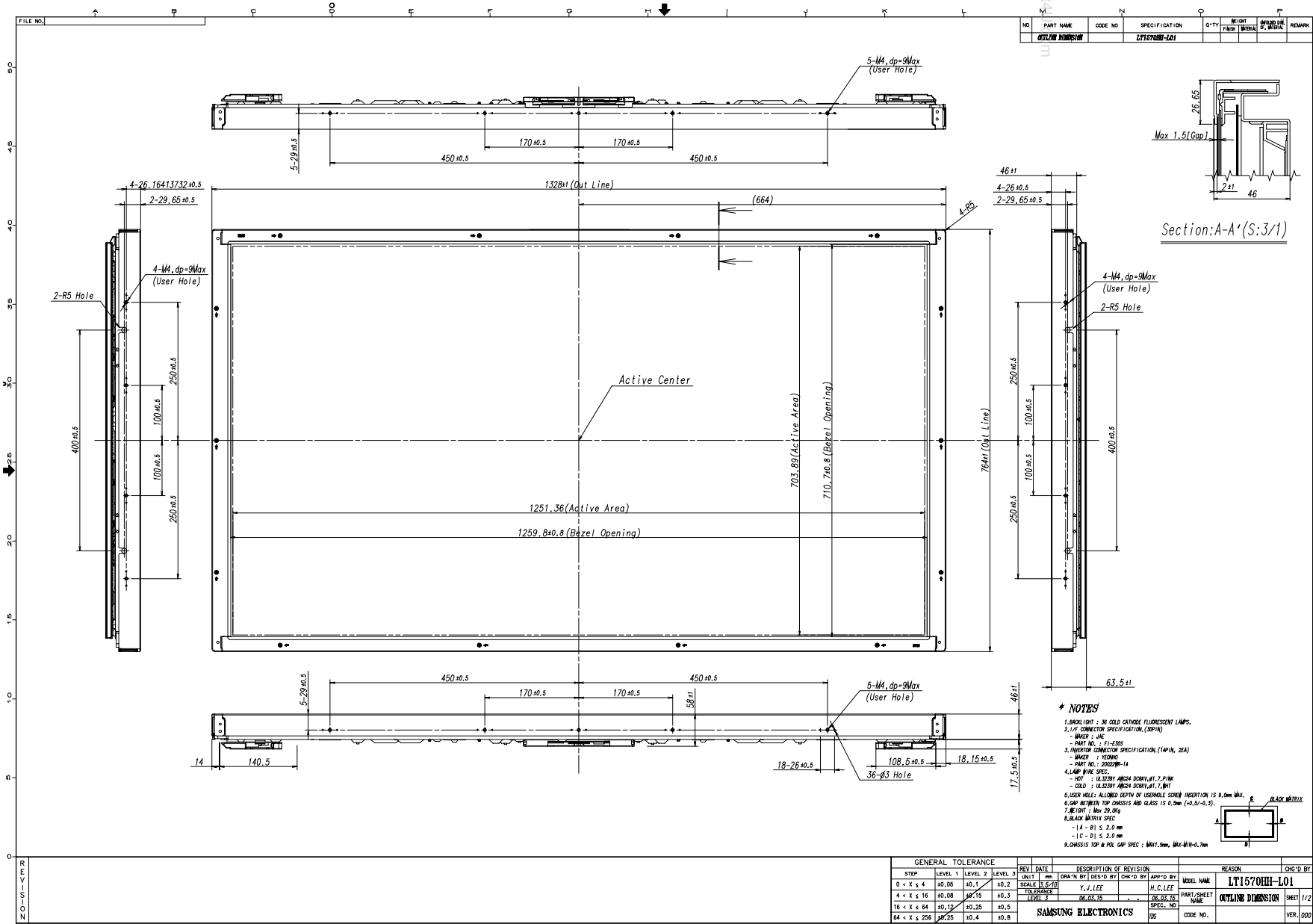

NO	PART NAME	CODE NO	SPECIFICATION	QTY	HEIGHT	WARRANTY	REMARK
	OUTLINE DIMENSION		LTI570HH-L01				

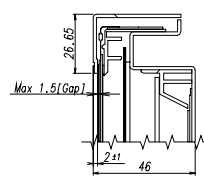

- \* NOTES**
- BACKLIGHT : 36 COLD CATHODE FLUORESCENT LAMPS.
  - 1/4" DIMENSION SPECIFICATION (30P/4)
  - UNLESS OTHERWISE SPECIFIED
  - PART NO. : F1-E300
  - INVERTER CONNECTOR SPECIFICATION (14PIN, 2EA)
  - WATER : TERNOM
  - PART NO. : 200220M-14
  - LAMP WIRE SPEC.
  - HOT : 10.32BY ARCHA DORNY #1, 7, PINK
  - COLD : 10.32BY ARCHA DORNY #1, 5, BLUE
  - USER HOLE: ALLOWED DEPTH OF USERHOLE SCREW INSERTION IS 9.0mm MAX.
  - GAP BETWEEN TOP ONDRESS AND GLASS IS 0.5mm (+0.5/-0.3).
  - HEIGHT : Max 29.0mm
  - BLACK MATRIX SPEC
  - BLACK MATRIX SPEC
  - 1A - 81 ≤ 2.0 mm
  - 1C - 81 ≤ 2.0 mm
  - ONDRESS TOP & PNL GAP SPEC : MAX1.5mm, MAX-MIN=0.7mm

GENERAL TOLERANCE				REV	DATE	DESCRIPTION OF REVISION		REASON		CHK'D BY
STEP	LEVEL 1	LEVEL 2	LEVEL 3	UNIT	mm	DRN BY	DES-D BY	CHK-D BY	APP'D BY	MODEL NAME
0 - X x 4	±0.00	±0.1	±0.2	SCALE	1:1	Y.J.LEE	H.C.LEE			LTI570HH-L01
X - X x 10	±0.00	±0.15	±0.3	TOLERANCE						
10 - X x 84	±0.12	±0.25	±0.5	LEVEL 2						
84 - X x 256	±0.20	±0.4	±0.8							

www.DataSheet4U.com

# 7. Outline Dimension (Rear View)

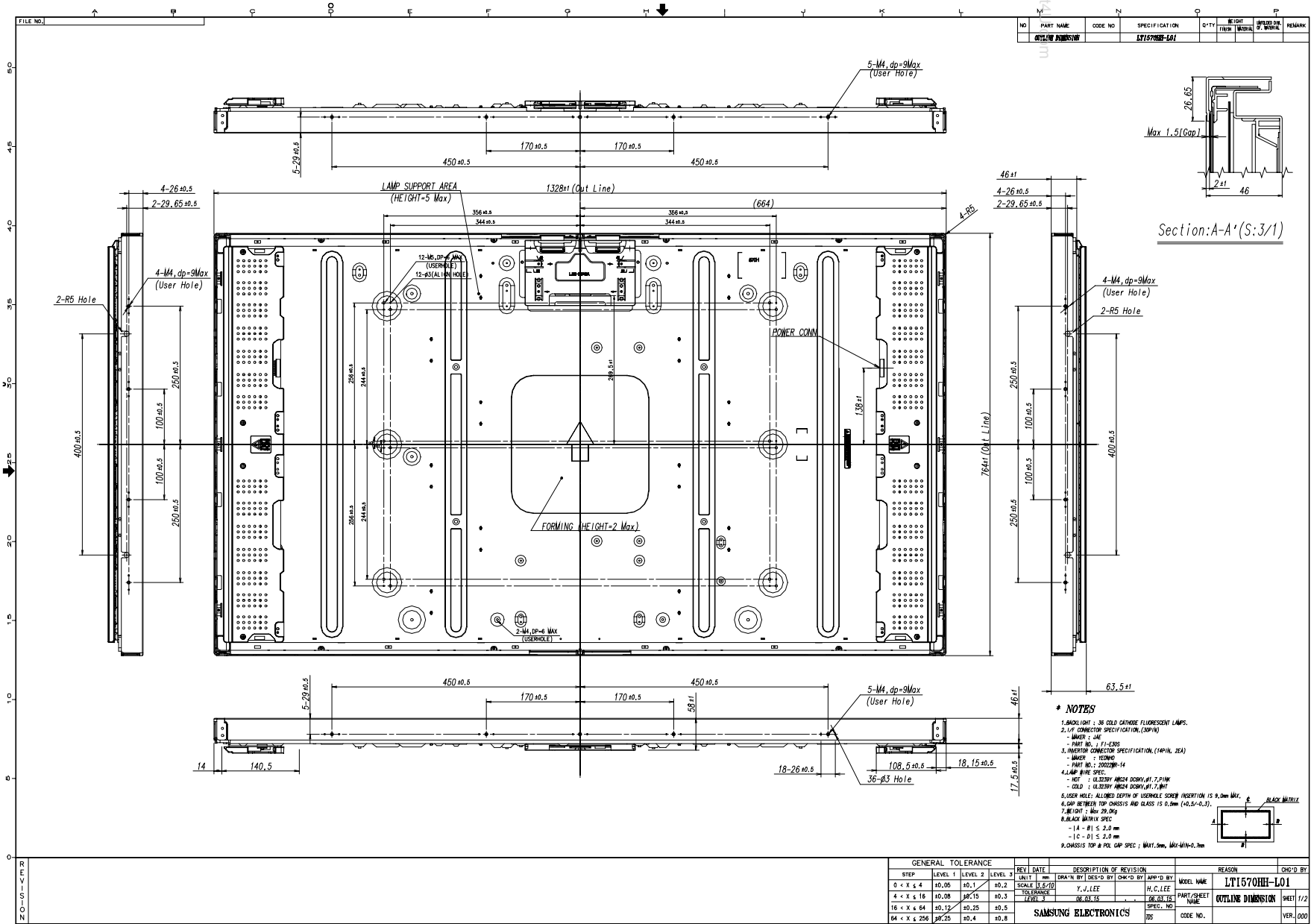

www.DataSheet4U.com

www.DataSheet4U.com

Model

LTI570HH-L01

Doc. No

05-003-G-070215

Page

22 / 27

## 8. PACKING

### 8.1 CARTON (Internal Package)

(1) Packing Form

Corrugated fiberboard box and corrugated cardboard as shock absorber

(2) Packing Method

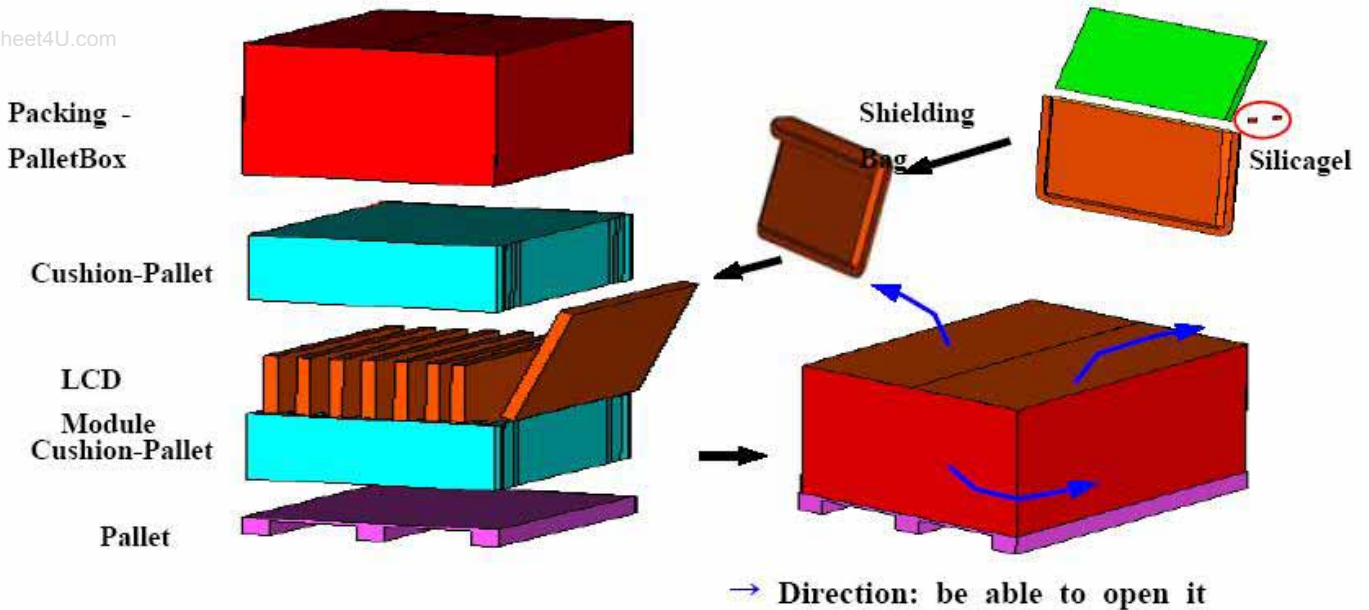

### 8.2 Packing Specification

Item	Specification	Remark
LCD Packing	8ea / (Packing-Pallet Box)	1. 244.8Kg / LCD (8ea) 2. 16 Kg / Cushion-pallet (2ea) 3. 10.5 Kg / Packing-Pallet Box (1ea) 4. Cushion-pallet Material : EPS 5. Packing-Pallet Box Material : DW4
Pallet	1Box / Pallet	1. Pallet weight = 10kg
Packing Direction	Vertical	
Total Pallet Size	H x V x height	1475mm(H) x 1150mm(V) x 995mm(height)
Total Pallet Weight	281.3 Kg	Pallet(10kg) + Module (30.6*8=244.8kg) + Cushion (up + bottom=16kg) + Pallet-Box(10.5kg)

## 9. MARKING & OTHERS

A nameplate bearing followed by is affixed to a shipped product at the specified location on each product.

- (1) Part number : LTI570HH-L01
- (2) Revision: Three letters
- (3) Lot number : X X X X XXX XX X

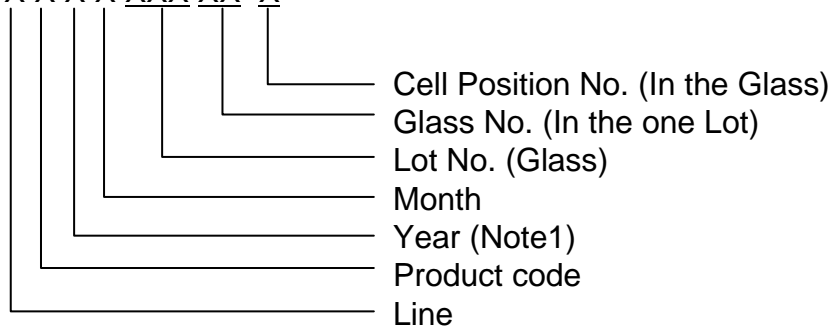

### (4) Nameplate Indication

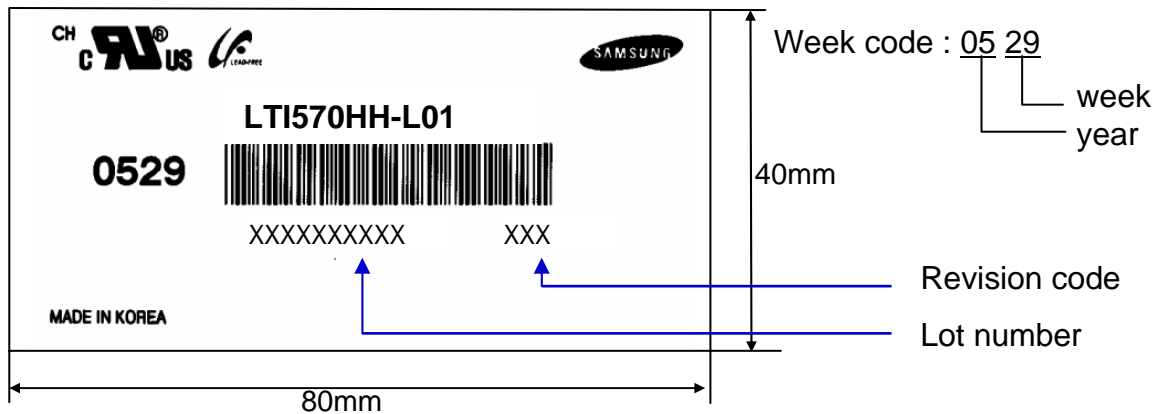

### (5) Packing box attach

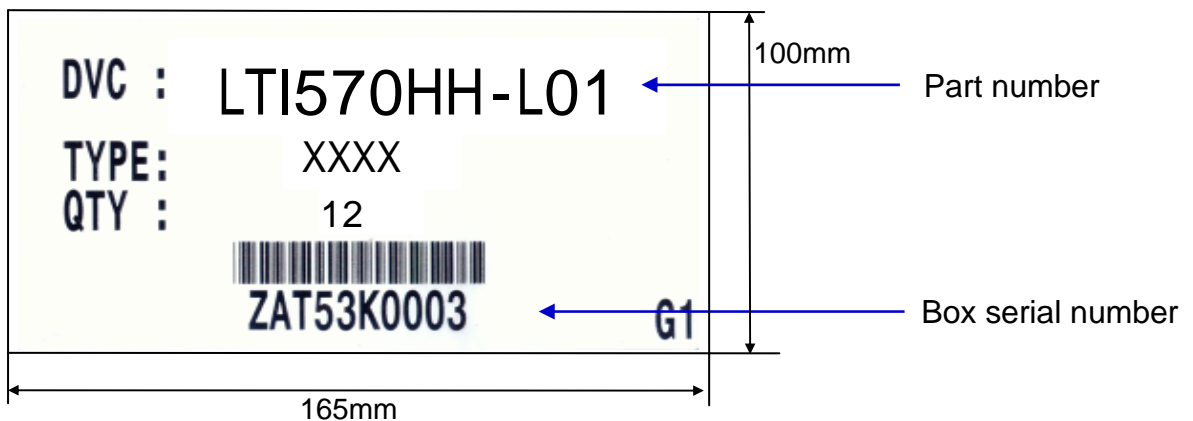

### (6) Others

- 1. After service part  
Lamps cannot be replaced because of the narrow bezel structure.

MODEL	LTI570HH-L01	Doc. No	05-003-G-070215	Page	24 / 27
-------	--------------	---------	-----------------	------	---------



## 10. General Precautions

### 10.1 Handling

- (a) When the Module is assembled, it should be attached to the system firmly using all mounting holes. Be careful not to twist and bend the Module.
- (b) Because the inverter use high voltage, it should be disconnected from power before it is assembled or disassembled.
- (c) Refrain from strong mechanical shock and / or any force to the Module.  
In addition to damage, this may cause improper operation or damage to the Module and CCFT back light.
- (d) Note that polarizers are very fragile and could be damage easily.  
Do not press or scratch the surface harder than a HB pencil lead.
- (e) Wipe off water droplets or oil immediately. If you leave the droplets for a long time, staining or discoloration may occur.
- (f) If the surface of the polarizer is dirty, clean it using absorbent cotton or soft cloth.
- (g) Desirable cleaners are water, IPA(Isopropyl Alcohol) or Hexane.  
Do not use Ketone type materials(ex. Acetone), Ethyl alcohol, Toluene, Ethyl acid or Methyl chloride. It might permanent damage to the polarizer due to chemical reaction.
- (h) If the liquid crystal material leaks from the panel, it should be kept away from the eyes or mouth . In case of contact with hands, legs or clothes, it must be washed away with soap thoroughly.
- (i) Protect the Module from static, or the CMOS Gate Array IC would be damaged.
- (j) Use finger-stalls with soft gloves in order to keep display clean during the incoming inspection and assembly process.
- (k) Do not disassemble the Module.
- (l) Do not pull or fold the lamp wire.
- (m) Do not adjust the variable resistor located on the Module.
- (n) Protection film for polarizer on the Module should be slowly peeled off just before use so that the electrostatic charge can be minimized.
- (o) Pins of I/F connector should not be touched directly with bare hands.

MODEL	LTI570HH-L01	Doc. No	05-003-G-070215	Page	25 / 27
-------	--------------	---------	-----------------	------	---------

## 10.2 Storage

- (a) Do not leave the Module in high temperature, and high humidity for a long time. It is highly recommended to store the Module with temperature from 0 to 35 and relative humidity of less than 70%.
- (b) Do not store the TFT-LCD Module in direct sunlight.
- (c) The Module should be stored in a dark place. It is prohibited to apply sunlight or fluorescent light in storing.

## 10.3 Operation

- (a) Do not connect or disconnect the Module in the "Power On" condition.
- (b) Power supply should always be turned on/off by the "Power on/off sequence"
- (c) Module has high frequency circuits. Sufficient suppression to the electromagnetic interference should be done by system manufacturers. Grounding and shielding methods may be important to minimize the interference.
- (d) The cable between the back light connector and its inverter power supply should be connected directly with a minimized length. A longer cable between the back light and the inverter may cause lower luminance of lamp(CCFT) and may require higher startup voltage(Vs).

## 10.4 Operation Condition Guide

- (a) The LCD product should be operated under normal conditions. Normal condition is defined as below;
  - Temperature :  $20 \pm 15$
  - Humidity :  $55 \pm 20\%$
  - Display pattern : continually changing pattern (Not stationary)
- (b) If the product will be used in extreme conditions such as high temperature, humidity, display patterns or operation time etc., It is strongly recommended to contact SEC for Application engineering advice. Otherwise, its reliability and function may not be guaranteed. Extreme conditions are commonly found at Airports, Transit Stations, Banks, Stock market, and Controlling systems.

MODEL	LTI570HH-L01	Doc. No	05-003-G-070215	Page	26 / 27
-------	--------------	---------	-----------------	------	---------

## 10.5 Others

- (a) Ultra-violet ray filter is necessary for outdoor operation.
- (b) Avoid condensation of water. It may result in improper operation or disconnection of electrode.
- (c) Do not exceed the absolute maximum rating value. ( supply voltage variation, input voltage variation, variation in part contents and environmental temperature, and so on)  
Otherwise the Module may be damaged.
- (d) If the Module keeps displaying the same pattern for a long period of time, the image may be "sticked" to the screen.  
To avoid image sticking, it is recommended to use a screen saver.
- (e) This Module has its circuitry PCB's on the rear side and should be handled carefully in order not to be stressed.
- (f) Please contact SEC in advance when you display the same pattern for a long time.

MODEL	LTI570HH-L01	Doc. No	05-003-G-070215	Page	27 / 27
-------	--------------	---------	-----------------	------	---------