

Features

- S_{21} = 28.2 dB @ 2363 MHz
= 27.8 dB @ 2390 MHz
- NF of 0.8 dB over Frequency
- Unconditionally Stable
- Single 5V Supply
- High OIP3 @ Low Current

Description

The plerow™ ALN-series is the compactly designed surface-mount module for the use of the LNA with or without the following gain blocks in the infrastructure equipment of the mobile wireless (CDMA, GSM, PCS, PHS, WCDMA, DMB, WLAN, WiBro, WiMAX), GPS, satellite communication terminals, CATV and so on. It has an exceptional performance of low noise figure, high gain, high OIP3, and low bias current. The stability factor is always kept more than unity over the application band in order to ensure its unconditionally stable implementation to the application system environment. The surface-mount module package including the completed matching circuit and other components necessary just in case allows very simple and convenient implementation onto the system board in mass production level.

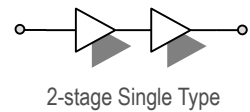

Specifications (in Production)

Typ. @ T = 25°C, V_s = 5 V, Freq. = 2376 MHz, $Z_{o,sys}$ = 50 ohm

Parameter	Unit	Specifications		
		Min	Typ	Max
Frequency Range	MHz	2363		2390
Gain	dB	27	28	
Gain Flatness	dB		± 0.2	± 0.3
Noise Figure	dB		0.80	0.85
Output IP3 ⁽¹⁾	dBm	35	36	
S11 / S22 ⁽²⁾	dB			-18 / -10
Output P1dB	dBm	20	21	
Switching Time ⁽³⁾	μsec		3	
Supply Current	mA		100	120
Supply Voltage	V		5	
Impedance	Ω		50	
Max. RF Input Power	dBm	C.W 29 ~ 31 (before fail)		
Package Type & Size	mm	Surface Mount Type, 13Wx13Lx3.8H		

More Information

Website: www.asb.co.kr
E-mail: sales@asb.co.kr
Tel: (82) 42-528-7223
Fax: (82) 42-528-7222

ASB Inc., 4th Fl. Venture Town Bldg., 367-17 Goijeong-Dong, Seo-Gu, Daejeon 302-716, Korea

Operating temperature is -40°C to +85°C.

1) OIP3 is measured with two tones at an output power of 5 dBm / tone separated by 1 MHz.

2) S11/S22 (max) is the worst value within the frequency band.

3) Switching time means the time that takes for output power to get stabilized to its final level after switching DC voltage from 0 V to V_s .

Outline Drawing (Unit: mm)

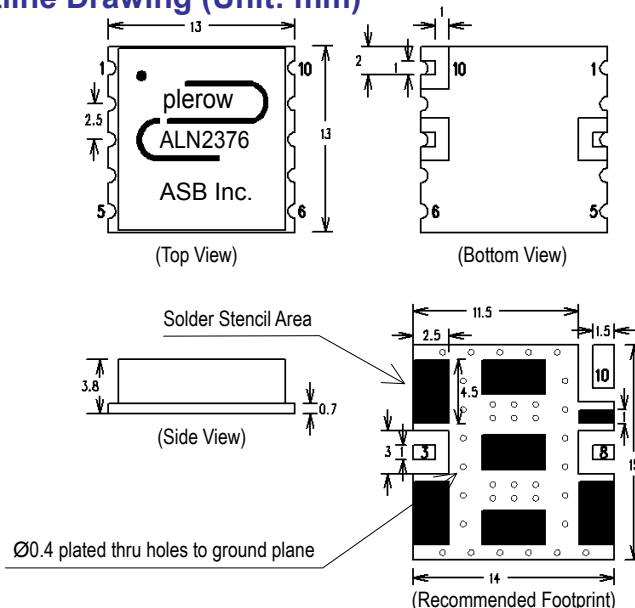

Pin Number	Function
3	RF In
8	RF Out
10	+Vcc
Others	Ground

Note: 1. The number and size of ground via holes in a circuit board is critical for thermal RF grounding considerations.

2. We recommend that the ground via holes be placed on the bottom of all ground pins for better RF and thermal performance, as shown in the drawing at the left side.

**Typical Performance
(Measured)**

2363~2390

+5 V

S-parameters

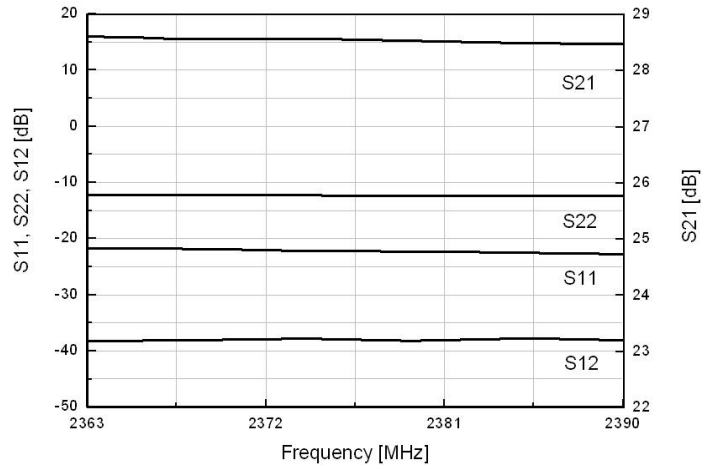

S-parameters & K Factor

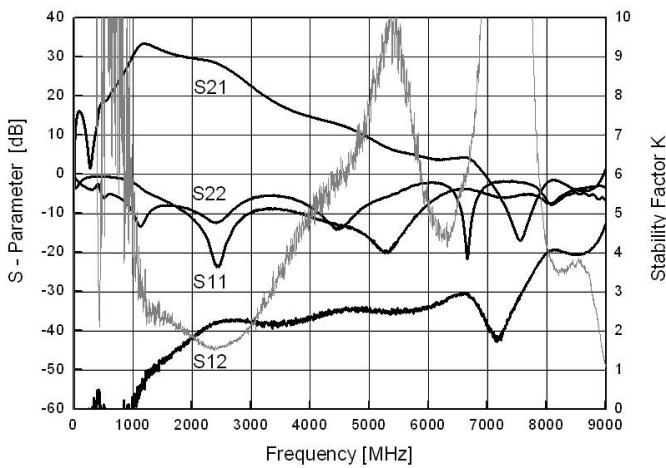

Noise Figure

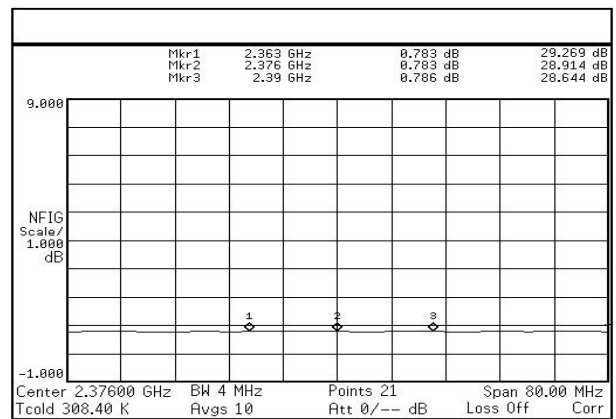

OIP3

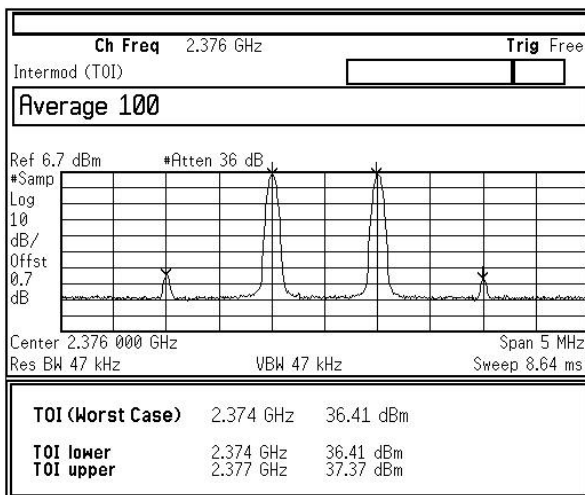

P1dB

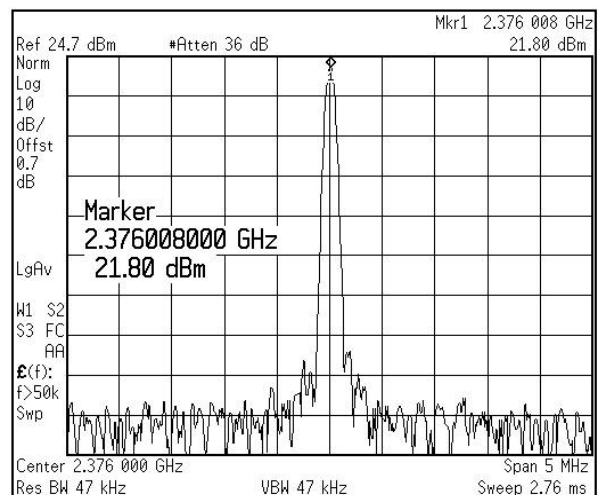

RF Performance with Voltage Change

Item Voltage	S11 (dB)	S22 (dB)	S21 (dB)	G/F (dB)	NF (dB)	P1dB (dBm)	OIP3 (dBm)	Current (mA)
4.5	-20.94	-12.78	28.32	0.15	0.788	21.28	36.55	77
4.6	-21.26	-12.69	28.36	0.15	0.786	21.48	36.77	83
4.7	-21.80	-12.66	28.40	0.15	0.788	21.77	36.94	88
4.8	-22.24	-12.58	28.44	0.15	0.792	22.00	36.95	93
4.9	-22.59	-12.50	28.47	0.15	0.798	22.20	36.97	98
5.0	-23.36	-12.46	28.50	0.15	0.796	22.41	37.00	104
5.1	-23.67	-12.34	28.53	0.15	0.793	22.59	36.86	109
5.2	-23.94	-12.27	28.55	0.15	0.802	22.78	36.73	114
5.3	-24.22	-12.14	28.58	0.14	0.805	22.97	36.65	119
5.4	-24.66	-12.07	28.60	0.14	0.813	23.15	36.51	124
5.5	-24.97	-11.98	28.62	0.14	0.818	23.30	36.32	130

RF Performance with Operating Temperature

Item Temp.	S11 (dB)	S22 (dB)	S21 (dB)	G/F (dB)	NF (dB)	P1dB (dBm)	OIP3 (dBm)	Current (mA)
-40°C	-25.91	-11.28	29.28	0.16	0.532	22.13	37.39	91
-20°C	-26.11	-11.58	29.27	0.16	0.606	22.20	37.18	94
0°C	-25.50	-11.84	29.11	0.17	0.660	22.15	36.80	94
25°C	-24.49	-12.22	28.76	0.17	0.799	22.01	36.18	96
40°C	-24.30	-12.03	28.72	0.15	0.870	21.91	35.85	96
60°C	-23.84	-12.13	28.60	0.11	0.959	21.77	35.49	98
80°C	-23.50	-12.13	28.31	0.12	1.061	21.39	35.29	99
100°C	-23.39	-11.95	28.19	0.13	1.142	21.18	34.92	99

Application Circuit

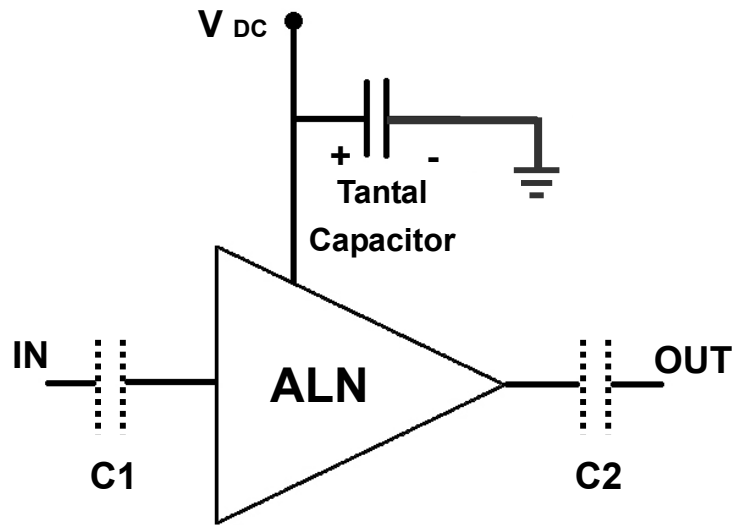

- 1) The tantal capacitor is optional and for bypassing the AC noise introduced from the DC supply. The capacitance value may be determined by customer's DC supply status.
- 2) So-called DC blocking capacitors are always necessarily placed at the input and output port for allowing only the RF signal to pass and blocking the DC component in the signal. The DC blocking capacitors are included inside the LNA module. Therefore, C1 & C2 capacitors may not be necessary, but can be added just in case that the customer wants. The value of C1 & C2 is determined by considering the application frequency.

Recommended Soldering Reflow Process

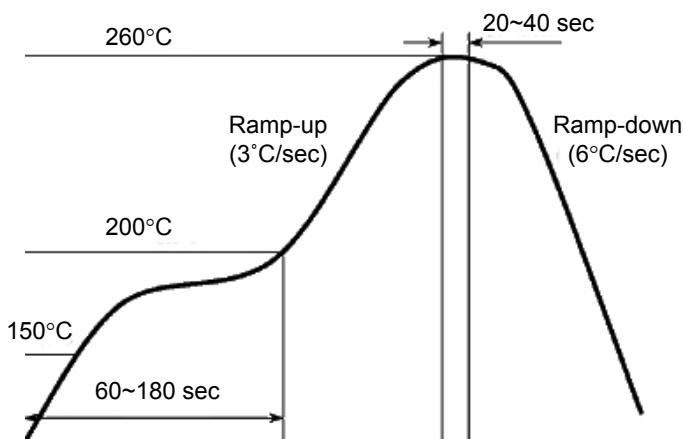

Evaluation Board Layout

