

MOSFET

Metal Oxide Semiconductor Field Effect Transistor

CoolMOS CP

600V CoolMOS™ CP Power Transistor
IPL60R385CP

Data Sheet

Rev. 2.0, 2010-10-01
Final

Industrial & Multimarket

1 Description

The CoolMOS™ CP series offers devices which provide all benefits of a fast switching SJ MOSFET while not sacrificing ease of use. Extremely low switching and conduction losses make switching applications even more efficient, more compact, lighter, and cooler.

ThinPAK

ThinPAK is a new leadless SMD package for HV MOSFETs. The new package has a very small footprint of only 64mm² (vs. 150mm² for the D²PAK) and a very low profile with only 1mm height (vs. 4.4mm for the D²PAK). The significantly smaller package size, combined with benchmark low parasitic inductances, provides designers with a new and effective way to decrease system solution size in power-density driven designs.

Features

- Reduced board space consumption
- Increased power density
- Short commutation loop
- Smooth switching waveform
- easy to use products
- Extremely low losses due to very low FOM $R_{DS(on)} \cdot Q_g$ and E_{oss}
- Qualified according to JEDEC¹⁾ for target applications (Server, Adapter)
- Pb-free plating, Halogen free

Applications: Server, Adapter

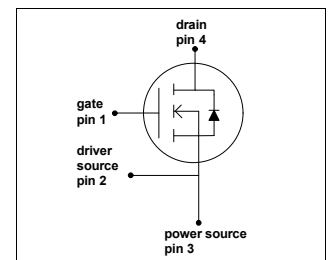
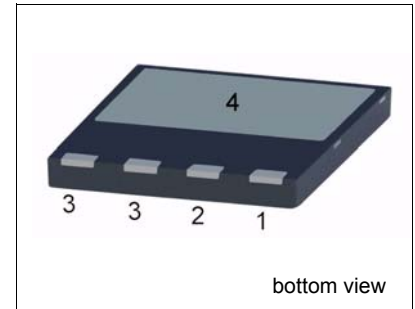

Table 1 Key Performance Parameters

Parameter	Value	Unit
$V_{DS} @ T_{j,max}$	650	V
$R_{DS(on),max}$	0.385	Ω
$Q_{g,typ}$	17	nC
$I_{D,pulse}$	27	A
$E_{oss} @ 400V$	3.2	μJ
Body diode di/dt	400	A/ μs

Related Links

- [IFX CP Product Brief](#)
- [IFX CP Portfolio](#)
- [IFX ThinPAK Webpage](#)
- [IFX Design tools](#)

Type	Package	Marking
IPL60R385CP	PG-VSON-4	6R385P

1) J-STD20 and JESD22

Table of Contents

1	Description	2
	Table of Contents	3
2	Maximum ratings	4
3	Thermal characteristics	4
4	Electrical characteristics	5
5	Electrical characteristics diagrams	7
6	Test circuits	11
7	Package outlines	12
8	Revision History	13

2 Maximum ratings

at $T_j = 25\text{ °C}$, unless otherwise specified.

Table 2 Maximum ratings

Parameter	Symbol	Values			Unit	Note / Test Condition
		Min.	Typ.	Max.		
Continuous drain current ¹⁾	I_D	-	-	9.0	A	$T_C = 25\text{ °C}$
				5.7		$T_C = 100\text{ °C}$
Pulsed drain current ²⁾	$I_{D,pulse}$	-	-	27	A	$T_C = 25\text{ °C}$
Avalanche energy, single pulse	E_{AS}	-	-	227	mJ	$I_D = 3.4\text{ A}, V_{DD} = 50\text{ V}$ (see table 17)
Avalanche energy, repetitive ²⁾³⁾	E_{AR}	-	-	0.34		$I_D = 3.4\text{ A}, V_{DD} = 50\text{ V}$
Avalanche current, repetitive ²⁾³⁾	I_{AR}	-	-	3.4	A	
MOSFET dv/dt ruggedness	dv/dt	-	-	50	V/ns	$V_{DS} = 0 \dots 480\text{ V}$
Gate source voltage	V_{GS}	-20	-	20	V	static
		-30		30		AC ($f > 1\text{ Hz}$)
Power dissipation	P_{tot}	-	-	83	W	$T_C = 25\text{ °C}$
Operating temperature	T_j	-40	-	150	°C	
Storage temperature	T_{stg}	-40	-	125	°C	
Continuous diode forward current	I_S	-	-	9.0	A	$T_C = 25\text{ °C}$
Diode pulse current ²⁾	$I_{S,pulse}$	-	-	27	A	$T_C = 25\text{ °C}$
Reverse diode dv/dt ⁴⁾	dv/dt	-	-	15	V/ns	$V_{DS} = 0 \dots 400\text{ V}, I_{SD} \leq I_D,$ $T_j = 25\text{ °C}$
Maximum diode commutation speed ⁴⁾	di/dt	-	-	400	A/ μs	(see table 18)

1) Limited by $T_{j,max}$. Maximum duty cycle

2) Pulse width t_p limited by $T_{j,max}$

3) Repetitive avalanche causes additional power losses that can be calculated as $P_{AV} = E_{AR} \cdot f$.

4) Identical low side and high side switch with identical R_G

3 Thermal characteristics

Table 3 Thermal characteristics

Parameter	Symbol	Values			Unit	Note / Test Condition
		Min.	Typ.	Max.		
Thermal resistance, junction - case	R_{thJC}	-	-	1.5	°C/W	
Thermal resistance, junction - ambient	R_{thJA}	-	-	45		SMD version, device on PCB, 6cm ² cooling area ¹⁾
Reflow soldering temperature	T_{sold}	-	-	260	°C	reflow MSL 3

1) Device on 40mm*40mm*1.5mm one layer epoxy PCB FR4 with 6cm² copper area (thickness 70 μm) for drain connection. PCB is vertical without air stream cooling.

4 Electrical characteristics

Electrical characteristics, at $T_J=25\text{ °C}$, unless otherwise specified.

Table 4 Static characteristics

Parameter	Symbol	Values			Unit	Note / Test Condition
		Min.	Typ.	Max.		
Drain-source breakdown voltage	$V_{(BR)DSS}$	600	-	-	V	$V_{GS}=0\text{ V}$, $I_D=0.25\text{ mA}$
Gate threshold voltage	$V_{GS(th)}$	2.5	3	3.5		$V_{DS}=V_{GS}$, $I_D=0.34\text{ mA}$
Zero gate voltage drain current	I_{DSS}	-	-	1	μA	$V_{DS}=600\text{ V}$, $V_{GS}=0\text{ V}$, $T_J=25\text{ °C}$
		-	10	-		$V_{DS}=600\text{ V}$, $V_{GS}=0\text{ V}$, $T_J=150\text{ °C}$
Gate-source leakage current	I_{GSS}	-	-	100	nA	$V_{GS}=20\text{ V}$, $V_{DS}=0\text{ V}$
Drain-source on-state resistance	$R_{DS(on)}$	-	0.35	0.385	Ω	$V_{GS}=10\text{ V}$, $I_D=5.2\text{ A}$, $T_J=25\text{ °C}$
		-	0.90	-		$V_{GS}=10\text{ V}$, $I_D=5.2\text{ A}$, $T_J=150\text{ °C}$
Gate resistance	R_G	-	1.8	-	Ω	$f=1\text{ MHz}$, open drain

Table 5 Dynamic characteristics

Parameter	Symbol	Values			Unit	Note / Test Condition
		Min.	Typ.	Max.		
Input capacitance	C_{iss}	-	790	-	pF	$V_{GS}=0\text{ V}$, $V_{DS}=100\text{ V}$, $f=1\text{ MHz}$
Output capacitance	C_{oss}	-	38	-		
Effective output capacitance, energy related ¹⁾	$C_{o(er)}$	-	36	-		
Effective output capacitance, time related ²⁾	$C_{o(tr)}$	-	96	-		$I_D=\text{constant}$, $V_{GS}=0\text{ V}$ $V_{DS}=0\dots480\text{ V}$
Turn-on delay time	$t_{d(on)}$	-	10	-	ns	$V_{DD}=400\text{ V}$, $V_{GS}=13\text{ V}$, $I_D=5.2\text{ A}$, $R_G=3.3\text{ }\Omega$ (see table 16)
Rise time	t_r	-	5	-		
Turn-off delay time	$t_{d(off)}$	-	40	-		
Fall time	t_f	-	5	-		

1) $C_{o(er)}$ is a fixed capacitance that gives the same stored energy as C_{oss} while V_{DS} is rising from 0 to 80% $V_{(BR)DSS}$

2) $C_{o(tr)}$ is a fixed capacitance that gives the same charging time as C_{oss} while V_{DS} is rising from 0 to 80% $V_{(BR)DSS}$

Table 6 Gate charge characteristics

Parameter	Symbol	Values			Unit	Note / Test Condition
		Min.	Typ.	Max.		
Gate to source charge	Q_{gs}	-	4	-	nC	$V_{DD}=480\text{ V}$, $I_D=5.2\text{ A}$, $V_{GS}=0\text{ to }10\text{ V}$
Gate to drain charge	Q_{gd}	-	6	-		
Gate charge total	Q_g	-	17	-		
Gate plateau voltage	$V_{plateau}$	-	5	-	V	

Table 7 Reverse diode characteristics

Parameter	Symbol	Values			Unit	Note / Test Condition
		Min.	Typ.	Max.		
Diode forward voltage	V_{SD}	-	0.9	-	V	$V_{GS}=0\text{ V}$, $I_F=5.2\text{ A}$, $T_j=25\text{ °C}$
Reverse recovery time	t_{rr}	-	260	-	ns	$V_R=400\text{ V}$, $I_F=5.2\text{ A}$, $di_F/dt=100\text{ A}/\mu\text{s}$ (see table 18)
Reverse recovery charge	Q_{rr}	-	3.1	-	μC	
Peak reverse recovery current	I_{rrm}	-	24	-	A	

5 Electrical characteristics diagrams

Table 8

Power dissipation	Max. transient thermal impedance
$P_{tot} = f(T_C)$	$Z_{(thJC)} = f(t_p)$; parameter: $D = t_p/T$

Table 9

Safe operating area $T_C = 25\text{ °C}$	Safe operating area $T_C = 80\text{ °C}$
$I_D = f(V_{DS}); T_C = 25\text{ °C}; D = 0$; parameter t_p	$I_D = f(V_{DS}); T_C = 80\text{ °C}; D = 0$; parameter t_p

Electrical characteristics diagrams

Table 10

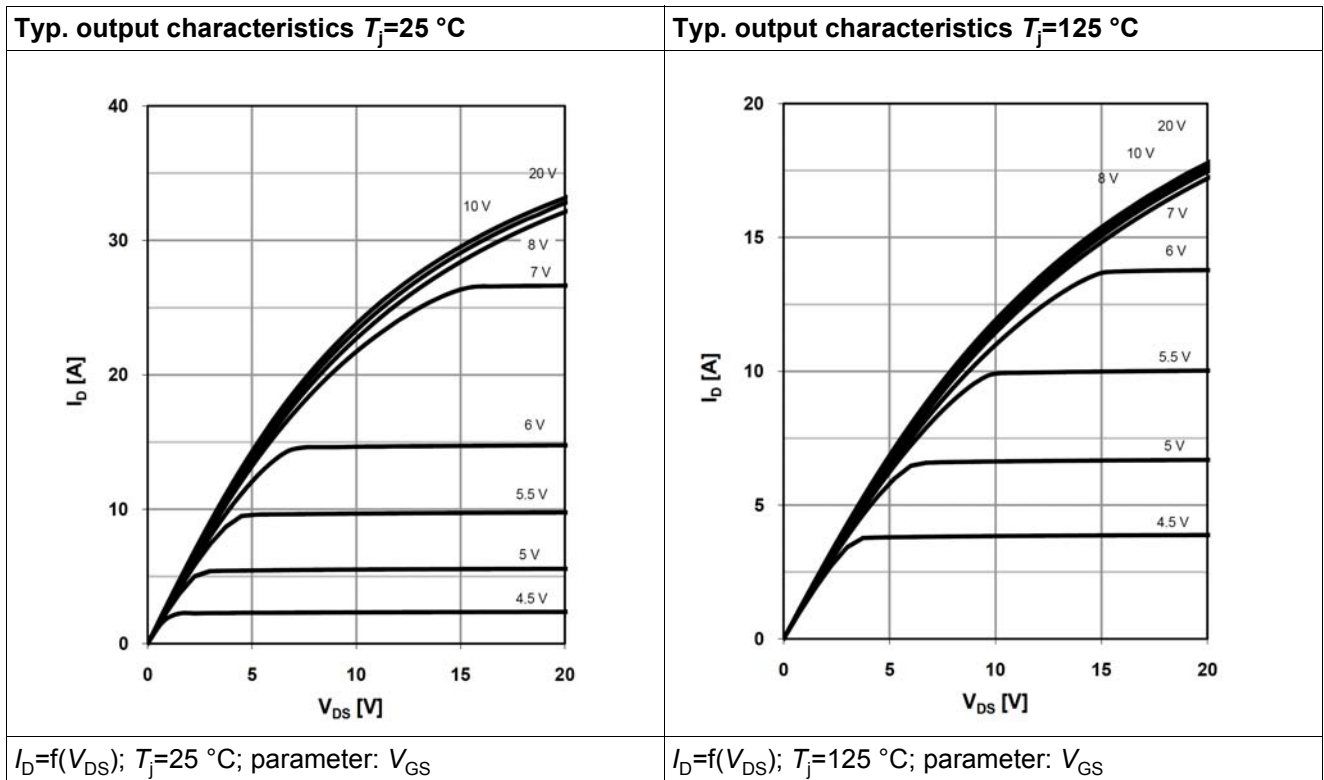

Table 11

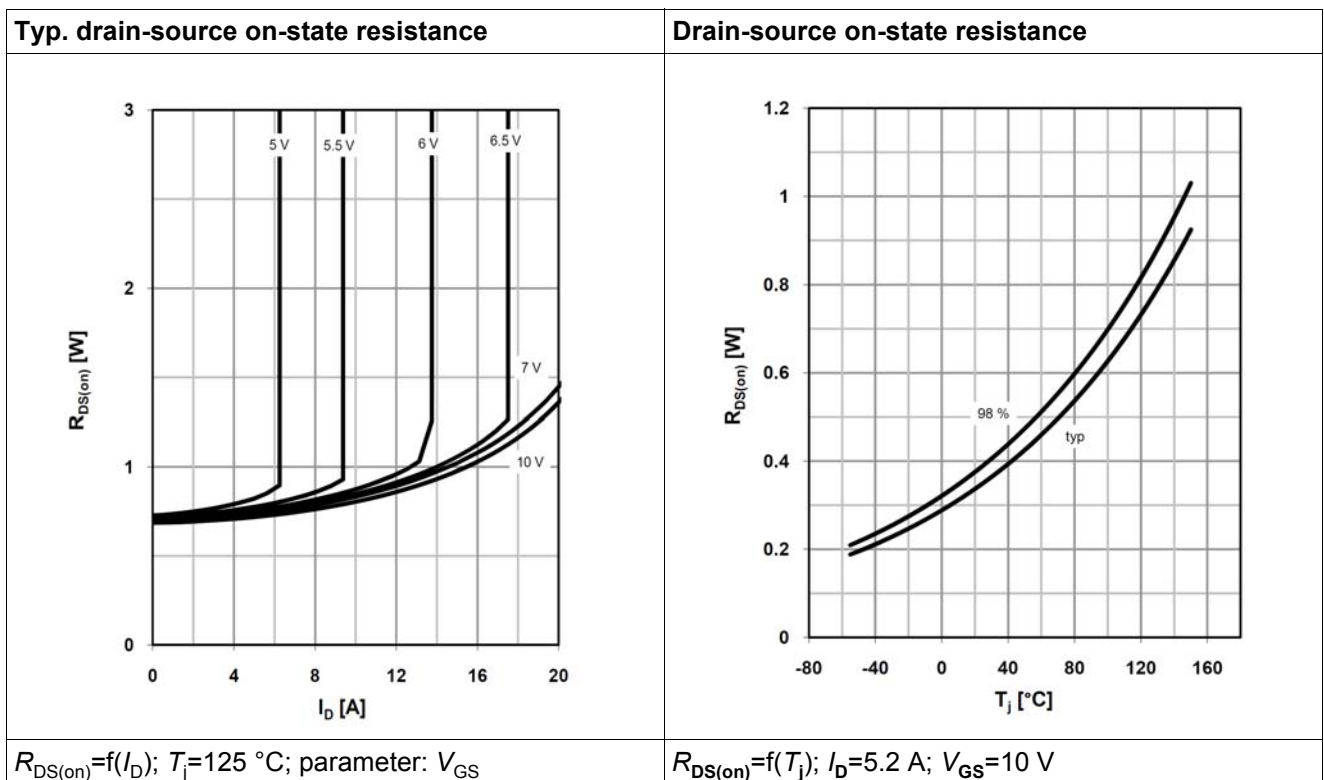

Table 12

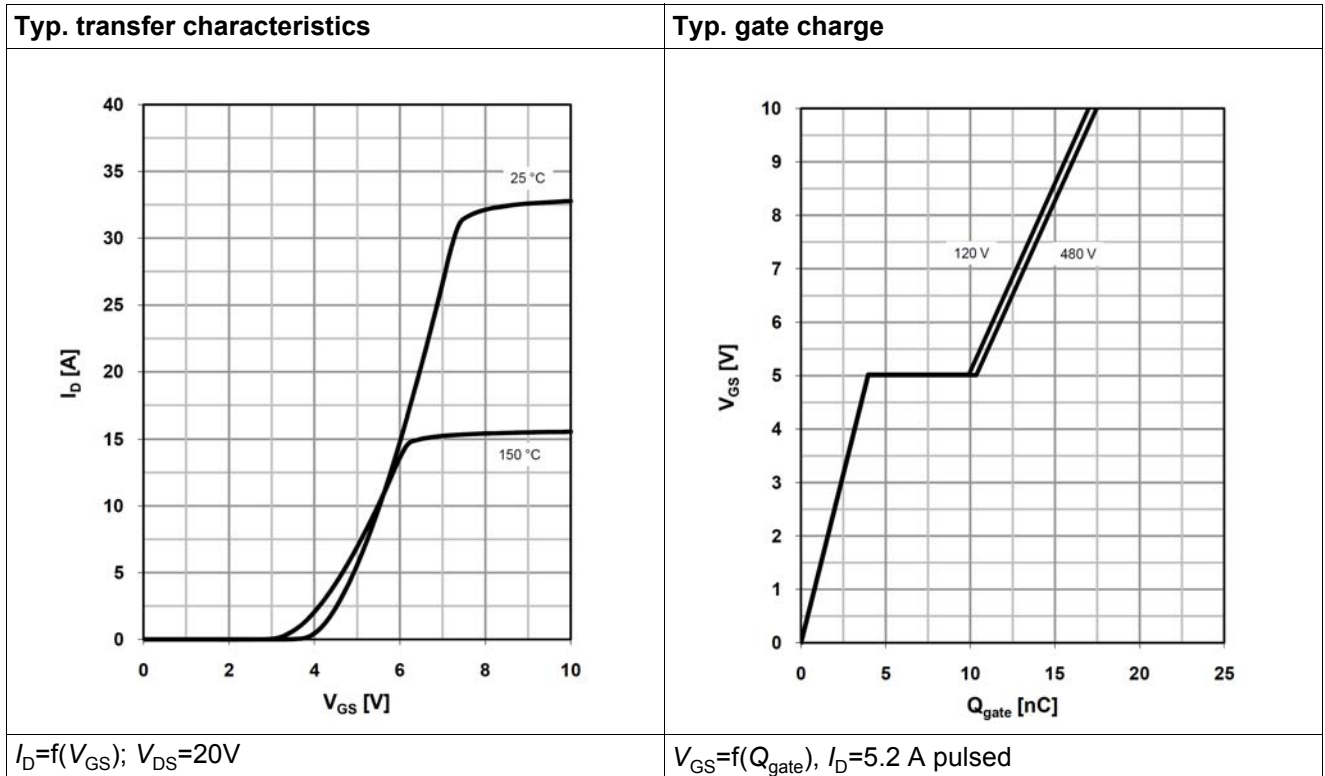

Table 13

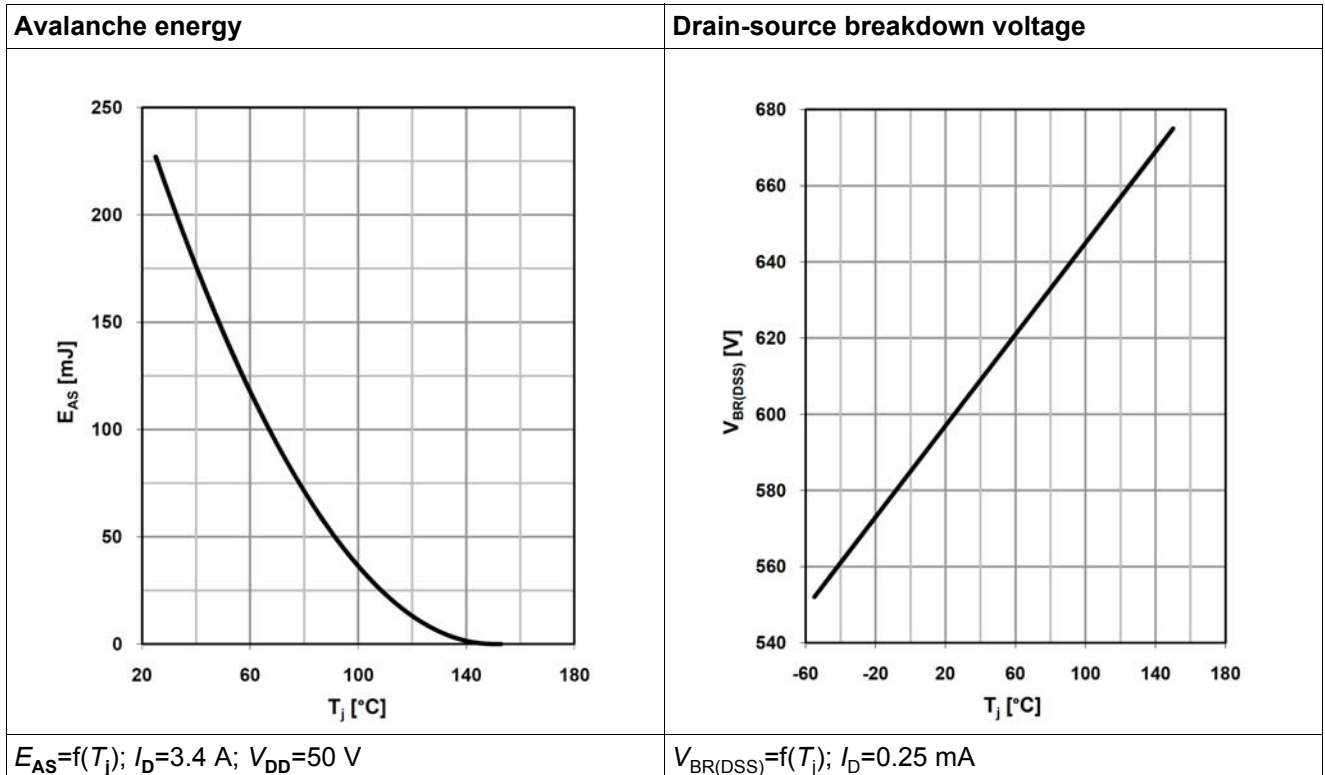

Table 14

Typ. capacitances	Typ. C_{oss} stored energy
$C=f(V_{DS}); V_{GS}=0\text{ V}; f=1\text{ MHz}$	$E_{Oss}=f(V_{DS})$

Table 15

Forward characteristics of reverse diode
$I_F=f(V_{SD}); \text{parameter: } T_j$

6 Test circuits

Table 16 Switching times test circuit and waveform for inductive load

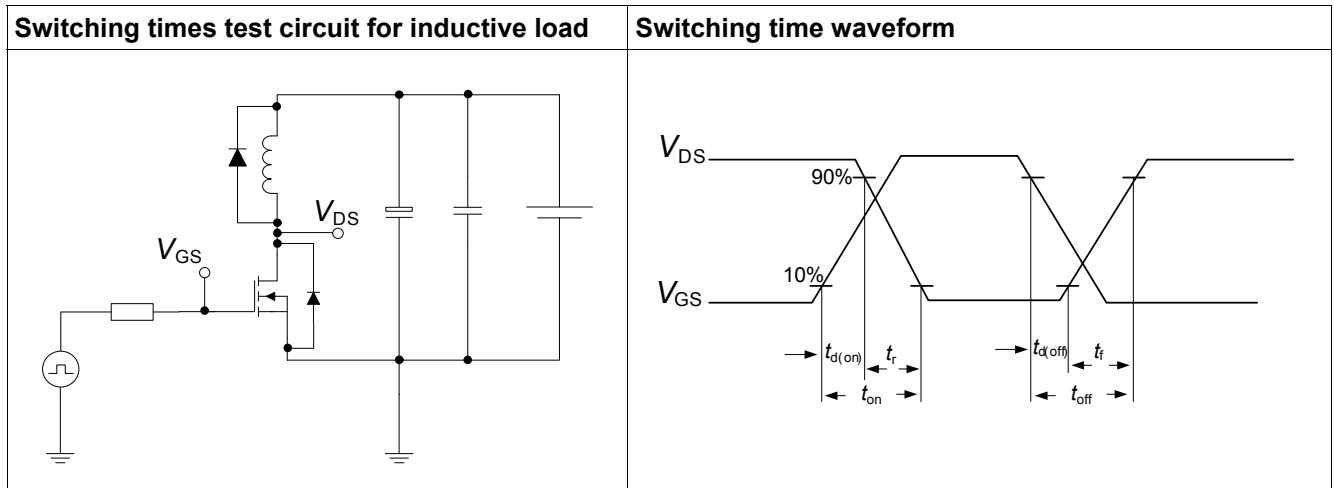

Table 17 Unclamped inductive load test circuit and waveform

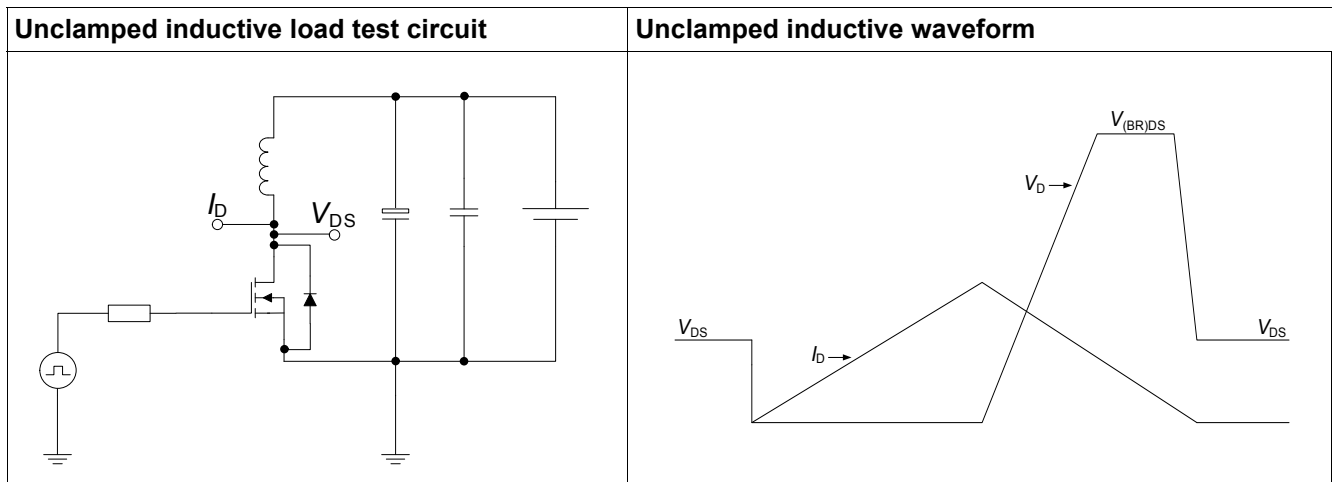
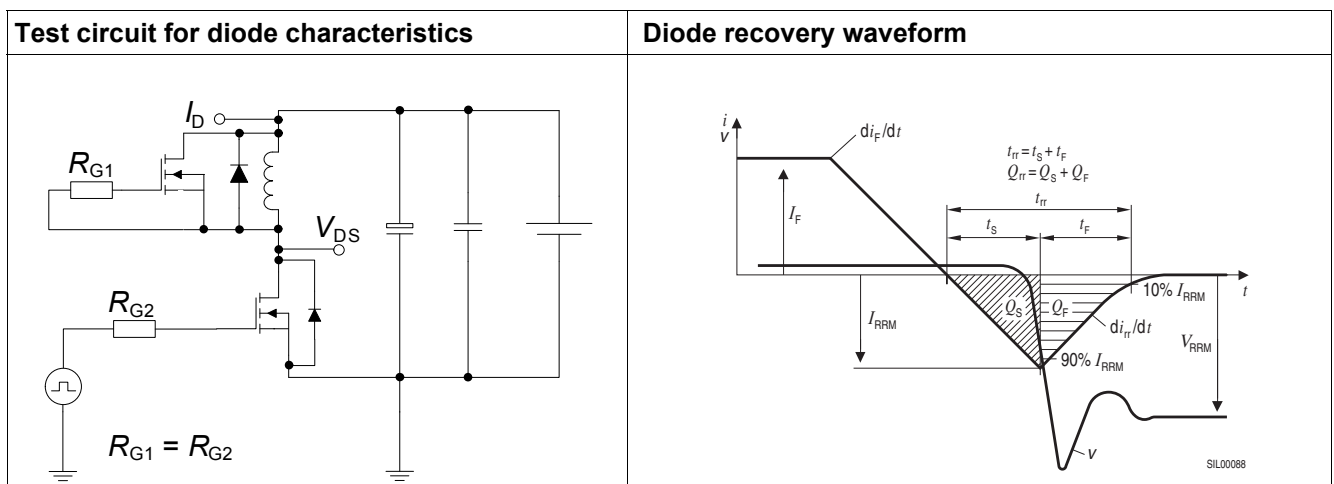
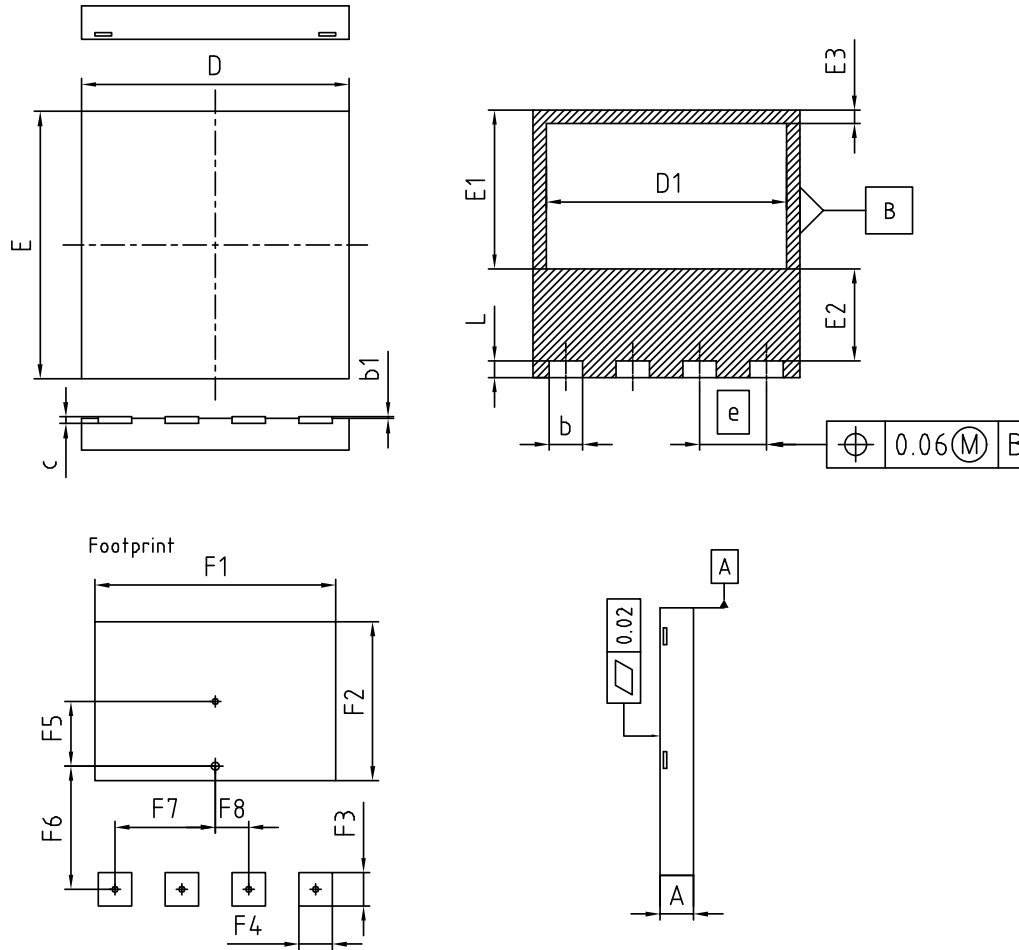

Table 18 Test circuit and waveform for diode characteristics



7 Package outlines



DIM	MILLIMETERS		INCHES	
	MIN	MAX	MIN	MAX
A	0.90	1.10	0.035	0.043
b	0.90	1.10	0.035	0.043
b1	0.00	0.05	0.000	0.002
c	0.10	0.30	0.004	0.012
D	7.90	8.10	0.311	0.319
D1	7.10	7.30	0.280	0.287
E	7.90	8.10	0.311	0.319
E1	4.65	4.85	0.183	0.191
E2	2.65	2.85	0.104	0.112
E3	0.30	0.50	0.012	0.020
e	2.00 (BSC)		0.079 (BSC)	
L	0.40	0.60	0.016	0.024
N	4		4	
F1	7.20		0.283	
F2	4.75		0.187	
F3	1.00		0.039	
F4	1.00		0.039	
F5	1.43		0.056	
F6	4.20		0.165	
F7	3.00		0.118	
F8	1.00		0.039	

DOCUMENT NO.
Z8B00156707

SCALE

EUROPEAN PROJECTION

ISSUE DATE
05-04-2010

REVISION
01

Figure 1 Outlines ThinPAK 8x8, dimensions in mm/inches

8 Revision History

Revision History: 2010-10-01, Rev. 2.0

Previous Revision:

Page	Subjects (major changes since last revision)
2.0	Release of final data sheet

We Listen to Your Comments

Any information within this document that you feel is wrong, unclear or missing at all?

Your feedback will help us to continuously improve the quality of this document.

Please send your proposal (including a reference to this document) to: erratum@infineon.com



Edition 2010-10-01

Published by

Infineon Technologies AG

81726 Munich, Germany

© 2010 Infineon Technologies AG

All Rights Reserved.

Legal Disclaimer

The information given in this document shall in no event be regarded as a guarantee of conditions or characteristics. With respect to any examples or hints given herein, any typical values stated herein and/or any information regarding the application of the device, Infineon Technologies hereby disclaims any and all warranties and liabilities of any kind, including without limitation, warranties of non-infringement of intellectual property rights of any third party.

Information

For further information on technology, delivery terms and conditions and prices, please contact the nearest Infineon Technologies Office (www.infineon.com).

Warnings

Due to technical requirements, components may contain dangerous substances. For information on the types in question, please contact the nearest Infineon Technologies Office.

Infineon Technologies components may be used in life-support devices or systems only with the express written approval of Infineon Technologies, if a failure of such components can reasonably be expected to cause the failure of that life-support device or system or to affect the safety or effectiveness of that device or system. Life support devices or systems are intended to be implanted in the human body or to support and/or maintain and sustain and/or protect human life. If they fail, it is reasonable to assume that the health of the user or other persons may be endangered.