



IGBT Module Preliminary Data

BSM 200 GA 100 D

$V_{CE} = 1000 \text{ V}$

$I_C = 275 \text{ A at } T_C = 25 \text{ °C}$

$I_C = 200 \text{ A at } T_C = 80 \text{ °C}$

- Power module
- Single switch
- Including fast free-wheel diodes
- Package with insulated metal base plate
- Package outlines/Circuit diagram: 4¹⁾

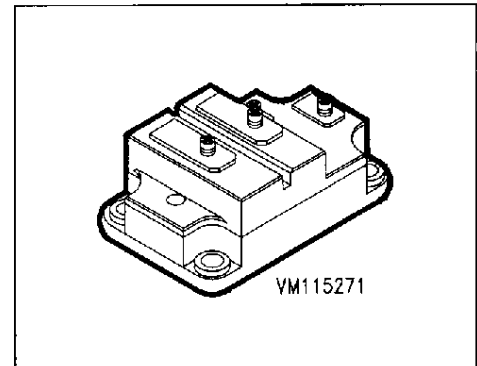

Single switch

Type	Ordering Code
BSM 200 GA 100 D	C67076-A2001-A2

Maximum Ratings

Parameter	Symbol	Values	Unit
Collector-emitter voltage	V_{CE}	1000	V
Collector-gate voltage, $R_{GE} = 20 \text{ k}\Omega$	V_{CGR}	1000	
Gate-emitter voltage	V_{GE}	± 20	
Continuous collector current, $T_C = 25 \text{ °C}$ $T_C = 80 \text{ °C}$	I_C	275 200	A
Pulsed collector current, $T_C = 25 \text{ °C}$ $T_C = 80 \text{ °C}$	$I_{C \text{ puls}}$	550 400	
Operating and storage temperature range	T_J, T_{stg}	- 55 ... + 150	°C
Power dissipation, $T_C = 25 \text{ °C}$	P_{tot}	1750	W
Thermal resistance, chip-case	R_{thJC}	≤ 0.07	K/W
Insulation test voltage ²⁾ , $t = 1 \text{ min.}$	V_{is}	2500	V _{ac}
Creepage distance	—	16	mm
Clearance	—	11	
DIN humidity category, DIN 40 040	—	F	—
IEC climatic category, DIN IEC 68-1	—	55/150/56	

¹⁾ See chapter Package Outline and Circuit Diagrams

²⁾ Insulation test voltage between collector and metal base plate referred to standard climate 23/50 in acc with DIN 50 014, IEC 146, para. 492.1

SIEMENS AKTIENGESELLSCHAFT

Electrical Characteristicsat $T_j = 25\text{ °C}$, unless otherwise specified.

Parameter	Symbol	Values			Unit
		min.	typ.	max.	

Static Characteristics

Collector-emitter breakdown voltage $V_{GE} = 0, I_C = 4\text{ mA}$	$V_{(BR)CES}$	1000	–	–	V
Gate threshold voltage $V_{GE} = V_{CE}, I_C = 16\text{ mA}$	$V_{GE(th)}$	4.8	5.5	6.2	
Collector-emitter saturation voltage $V_{GE} = 15\text{ V}, I_C = 200\text{ A}$ $T_j = 25\text{ °C}$ $T_j = 150\text{ °C}$	$V_{CE(sat)}$	– –	2.8 4.0	3.3 4.5	
Zero gate voltage collector current $V_{CE} = 1000\text{ V}, V_{GE} = 0$ $T_j = 25\text{ °C}$ $T_j = 125\text{ °C}$	I_{CES}	– –	– –	4000	μA
Gate-emitter leakage current $V_{GE} = 20\text{ V}, V_{CE} = 0$	I_{GES}	–	–	100	nA

AC Characteristics

Forward transconductance $V_{CE} = 20\text{ V}, I_C = 200\text{ A}$	g_{fs}	72		–	S
Input capacitance $V_{CE} = 25\text{ V}, V_{GE} = 0, f = 1\text{ MHz}$	C_{iss}	–	32000	–	pF
Output capacitance, $V_{GS} = 0$ $V_{CE} = 25\text{ V}, V_{GE} = 0, f = 1\text{ MHz}$	C_{oss}	–	2600	–	
Reverse transfer capacitance $V_{CE} = 25\text{ V}, V_{GE} = 0, f = 1\text{ MHz}$	C_{rss}	–	1000	–	

SIEMENS AKTIENGESELLSCHAFT

Switching Characteristics

at $T_j = 125\text{ °C}$, unless otherwise specified.

Parameter	Symbol	Values			Unit
		min.	typ.	max.	

Resistive Load

Turn-on delay time $V_{CC} = 600\text{ V}, V_{GE} = 15\text{ V}, I_C = 200\text{ A}$ $R_{g(on)} = 3.3\ \Omega, R_{g(off)} = 3.3\ \Omega$	$t_{d(on)}$	–	200	–	ns
Rise time $V_{CC} = 600\text{ V}, V_{GE} = 15\text{ V}, I_C = 200\text{ A}$ $R_{g(on)} = 3.3\ \Omega, R_{g(off)} = 3.3\ \Omega$	t_r	–	440	–	
Turn-off delay time $V_{CC} = 600\text{ V}, V_{GE} = 15\text{ V}, I_C = 200\text{ A}$ $R_{g(on)} = 3.3\ \Omega, R_{g(off)} = 3.3\ \Omega$	$t_{d(off)}$	–	730	–	
Fall time $V_{CC} = 600\text{ V}, V_{GE} = 15\text{ V}, I_C = 200\text{ A}$ $R_{g(on)} = 3.3\ \Omega, R_{g(off)} = 3.3\ \Omega$	t_f	–	500	–	

Inductive Load

Turn-on delay time $V_{CC} = 600\text{ V}, V_{GE} = 15\text{ V}, I_C = 200\text{ A}$ $R_{g(on)} = 3.3\ \Omega, R_{g(off)} = 3.3\ \Omega$	$t_{d(on)}$	120	200	250	ns
Rise time $V_{CC} = 600\text{ V}, V_{GE} = 15\text{ V}, I_C = 200\text{ A}$ $R_{g(on)} = 3.3\ \Omega, R_{g(off)} = 3.3\ \Omega$	t_r	45	90	140	
Turn-off delay time $V_{CC} = 600\text{ V}, V_{GE} = 15\text{ V}, I_C = 200\text{ A}$ $R_{g(on)} = 3.3\ \Omega, R_{g(off)} = 3.3\ \Omega$	$t_{d(off)}$	550	730	900	
Fall time $V_{CC} = 600\text{ V}, V_{GE} = 15\text{ V}, I_C = 200\text{ A}$ $R_{g(on)} = 3.3\ \Omega, R_{g(off)} = 3.3\ \Omega$	t_f	80	110	140	
Turn-off loss ($E_{off} = E_{off1} + E_{off2}$) $V_{CC} = 600\text{ V}, V_{GE} = 15\text{ V}, I_C = 200\text{ A}$ $R_{g(on)} = 3.3\ \Omega, R_{g(off)} = 3.3\ \Omega$	E_{off1} E_{off2}	– –	15 10	– –	mWs

Electrical Characteristicsat $T_J = 25\text{ °C}$, unless otherwise specified.

Parameter	Symbol	Values			Unit
		min.	typ.	max.	
Free-Wheel Diode					
Diode forward voltage $I_F = 200\text{ A}$, $V_{GE} = 0$ $T_J = 25\text{ °C}$ $T_J = 125\text{ °C}$	V_F	– –	1.85 1.45	– –	V
Reverse recovery time $I_F = 200\text{ A}$, $V_R = 600\text{ V}$ $V_{GE} = 0$, $di_F/dt = -800\text{ A}/\mu\text{s}$ $T_J = 125\text{ °C}$	t_{rr}	–	0.4	–	μs
Reverse recovery charge $I_F = 200\text{ A}$, $V_R = 600\text{ V}$ $V_{GE} = 0$, $di_F/dt = -3000\text{ A}/\mu\text{s}$ $T_J = 25\text{ °C}$ $T_J = 125\text{ °C}$	Q_{rr}	– –	12 36	– –	μC
Soft factor $I_F = 200\text{ A}$, $V_R = 600\text{ V}$ $V_{GE} = 0$, $di_F/dt = -3000\text{ A}/\mu\text{s}$ $T_J = 125\text{ °C}$	S	–	1	–	–
Thermal resistance Chip-case	R_{thJC}	–	–	0.25	K/W

SIEMENS AKTIENGESELLSCHAFT

Characteristics at $T_j = 25^\circ\text{C}$, unless otherwise specified.

Power dissipation $P_{\text{tot}} = f(T_c)$

parameter: $T_j = 150^\circ\text{C}$

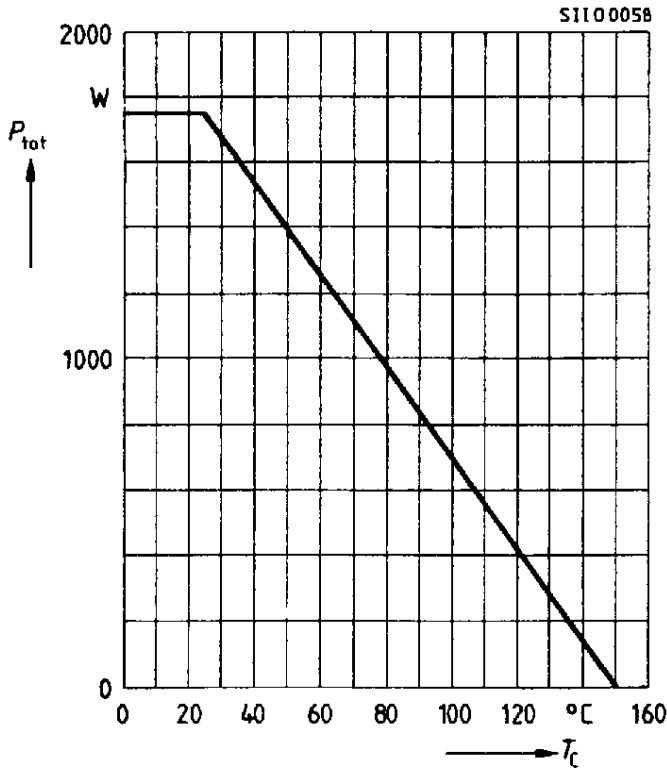

Safe operating area $I_C = f(V_{CE})$

parameter: single pulse, $T_c = 25^\circ\text{C}$

$T_j \leq 150^\circ\text{C}$

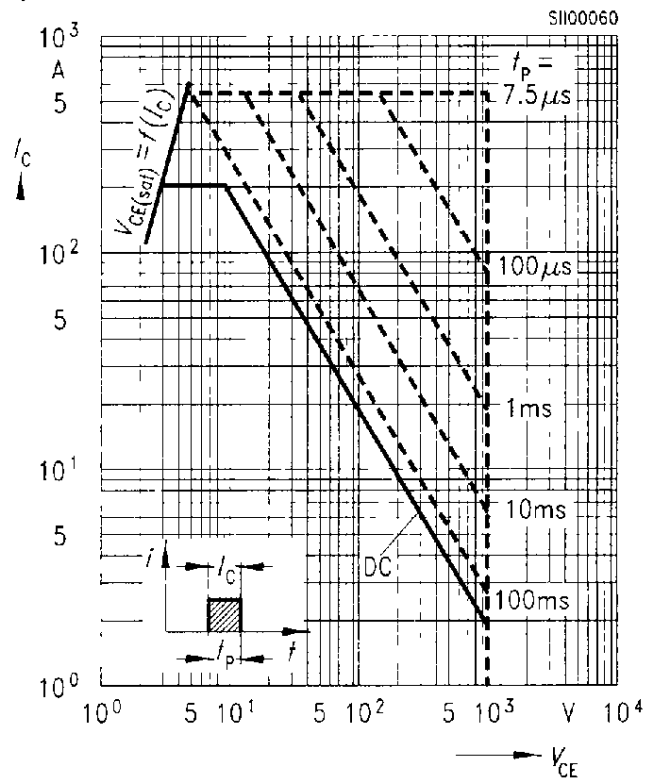

Typ. output characteristics $I_C = f(V_{CE})$

parameter: $t_p = 80 \mu\text{s}$, $T_j \leq 25^\circ\text{C}$

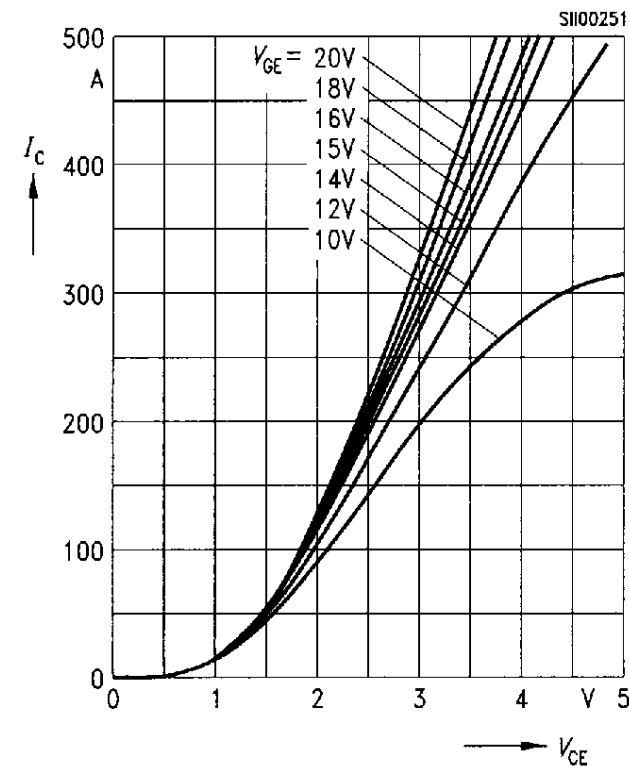

Typ. output characteristics $I_C = f(V_{CE})$

parameter: $t_p = 80 \mu\text{s}$, $T_j \leq 125^\circ\text{C}$

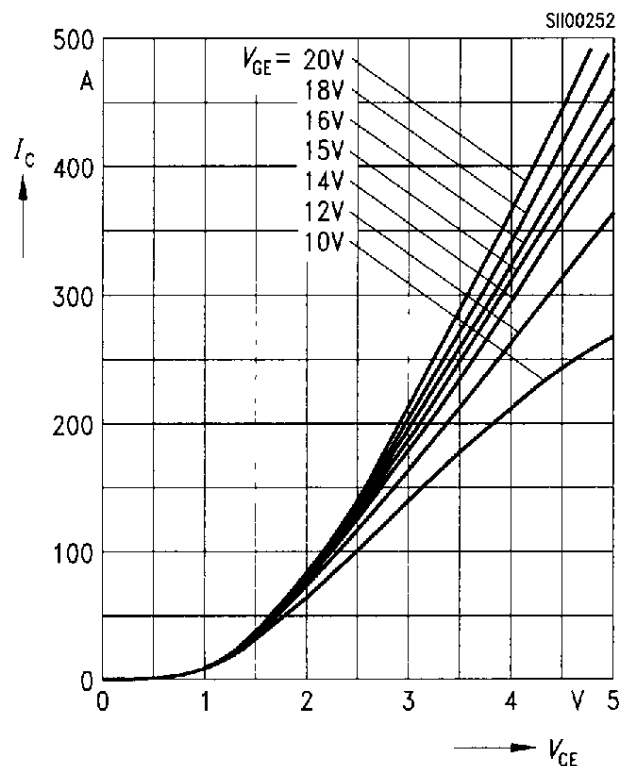

Reverse biased safe operating area

$I_C = f(V_{CE})$, parameter: $T_J = 125^\circ\text{C}$,
 $V_{GE} = 15\text{ V}$, $R_{g(\text{off})} = 3.3\ \Omega$,
 L (parasitic inductance, module) $< 50\text{ nH}$

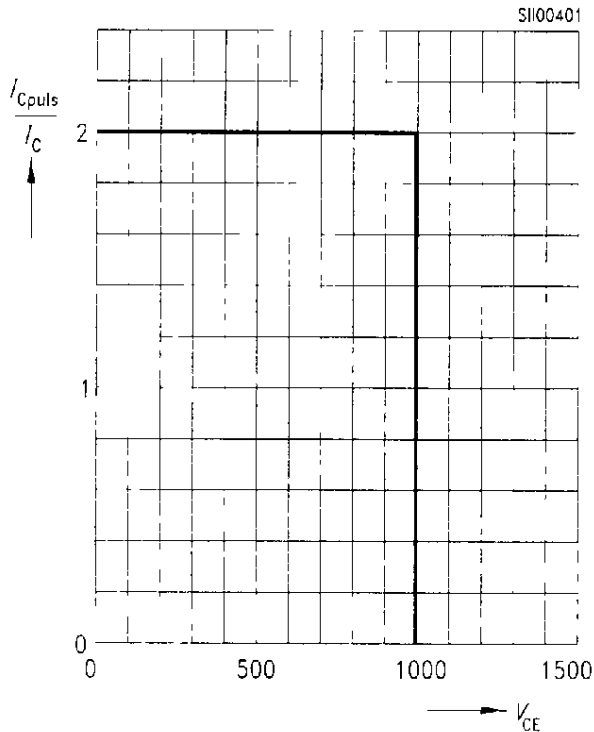

Safe operating area, short circuit

$I_C = f(V_{CE})$, $V_{GE} = \pm 15\text{ V}$
 $T_J \leq 150^\circ\text{C}$, $t_{SC} \leq 10\ \mu\text{s}$, $L < 80\text{ nH}$

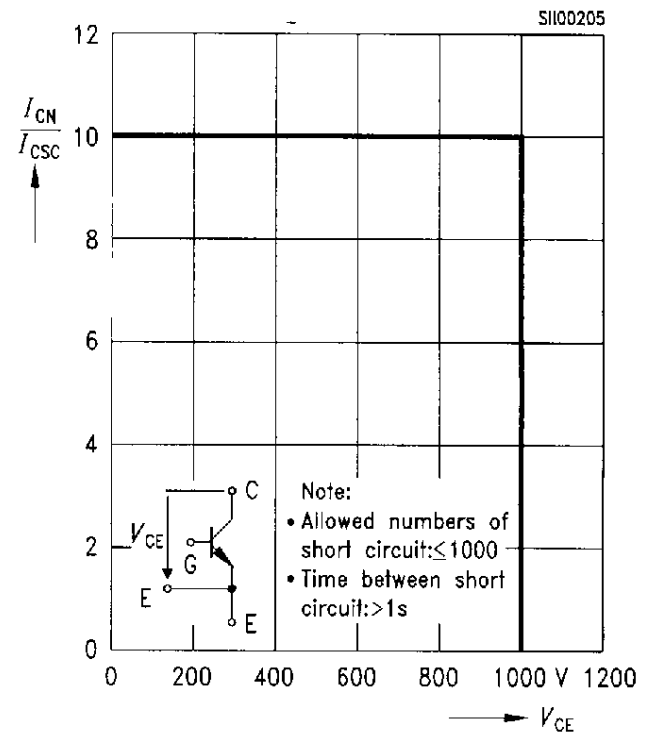

Transient thermal impedance

$Z_{thJC} = f(t_p)$, parameter: $D = t_p / T$

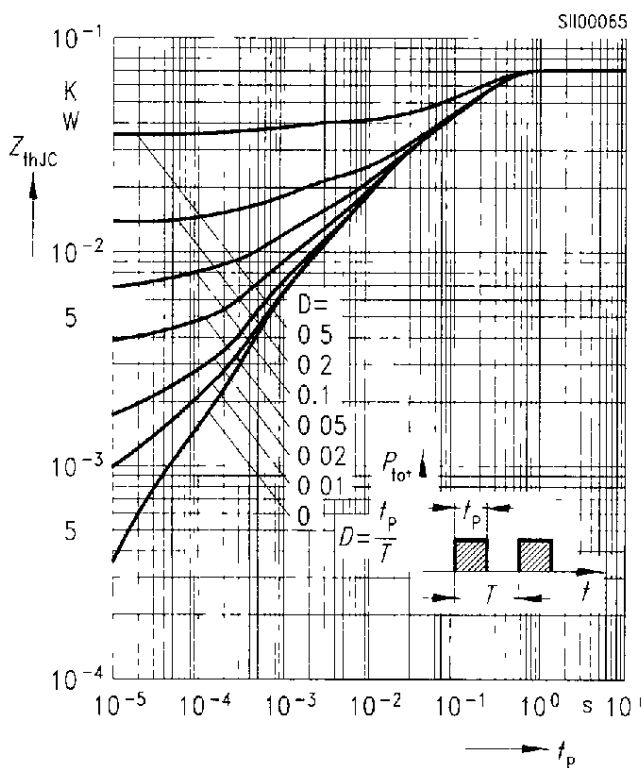

Typ. on-state characteristics

$V_{CE(sat)} = f(V_{GE})$, parameter: I_C , T_J

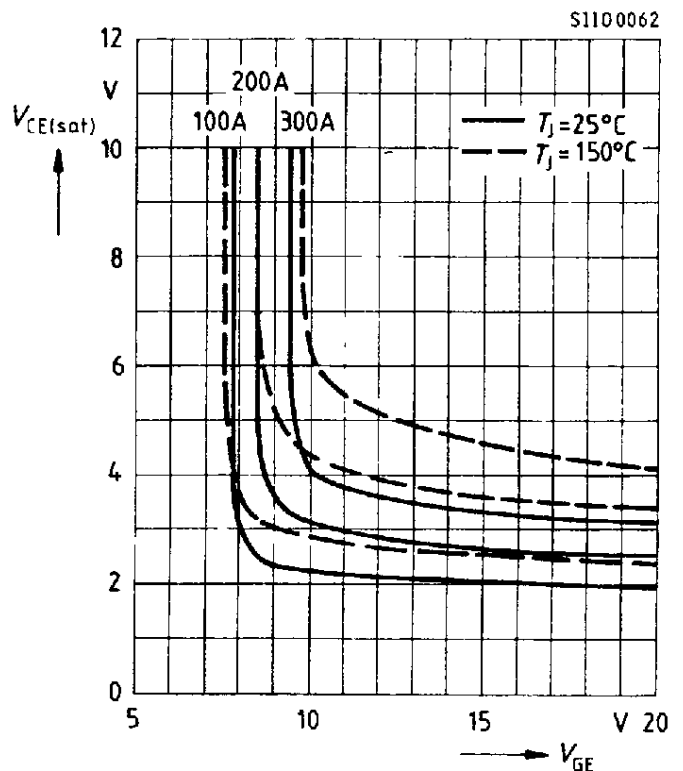

SIEMENS AKTIENGESELLSCHAFT

Collector current $I_C = f(T_C)$
 parameter: $V_{GE} \geq 15 \text{ V}$, $T_J = 150 \text{ }^\circ\text{C}$

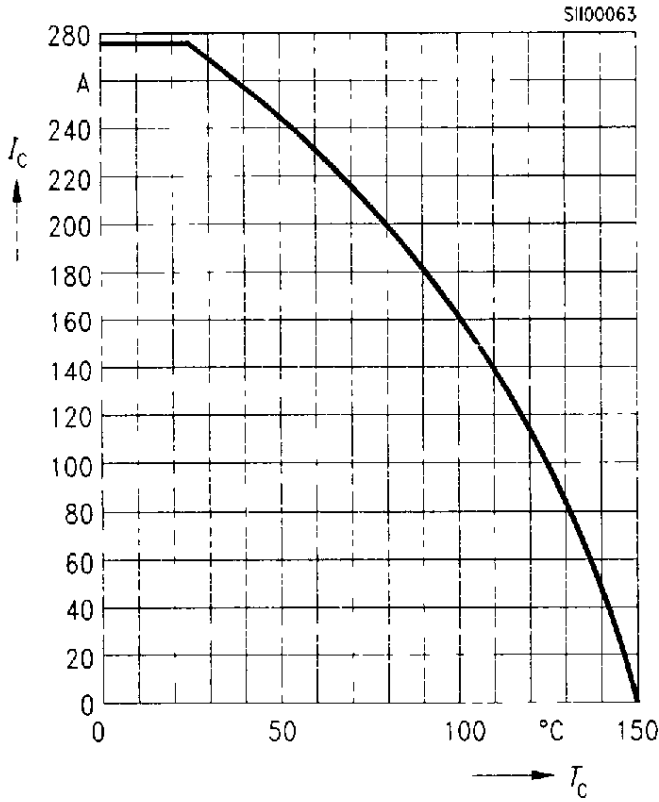

Typ. capacitances $C = f(V_{CE})$
 parameter: $V_{GE} = 0$, $f = 1 \text{ MHz}$

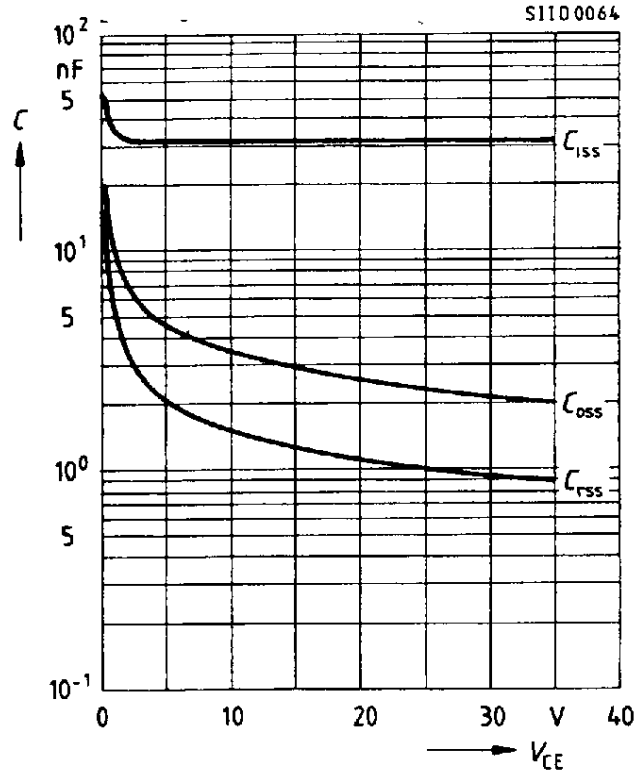

Typ. transfer characteristics $I_C = f(V_{GE})$
 parameter: $t_p = 80 \text{ } \mu\text{s}$, $V_{CE} = 20 \text{ V}$

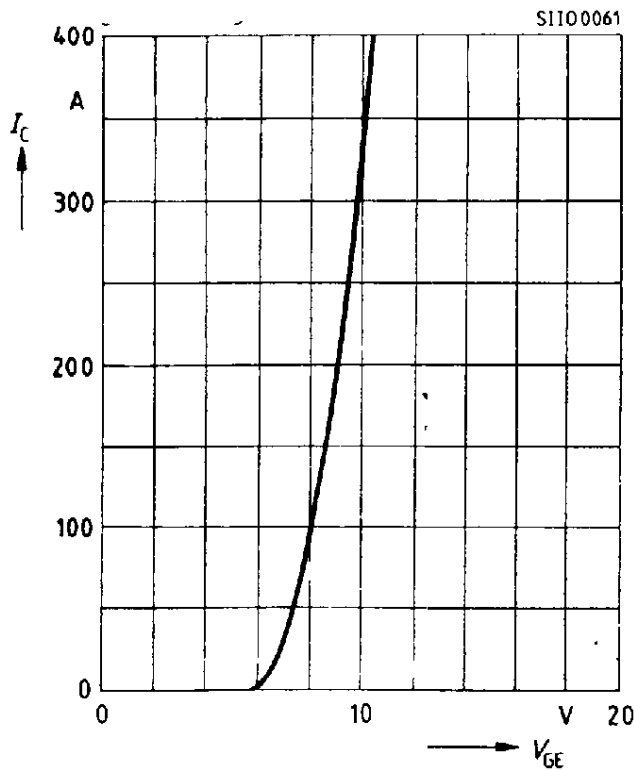

Typ. gate charge $V_{CE}, V_{GE} = f(Q_G)$

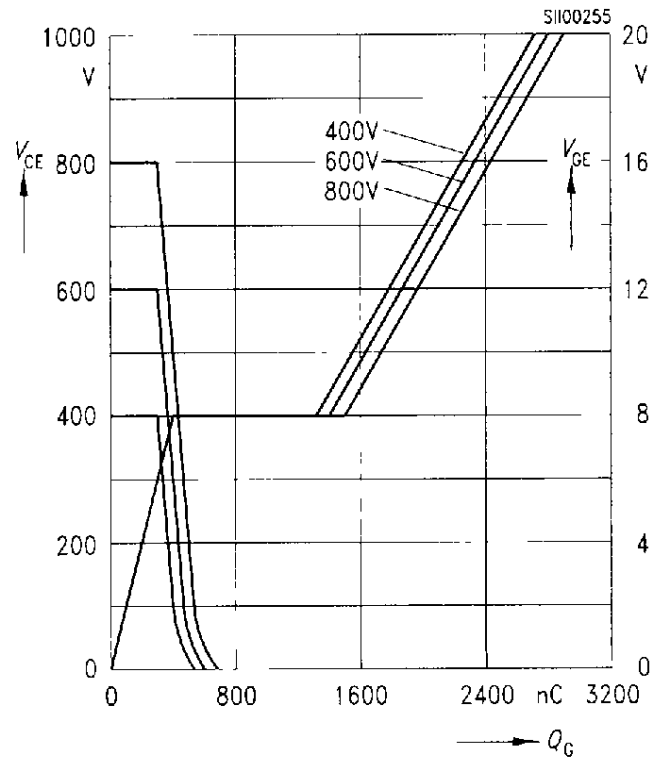

Forward characteristics of fast recovery reverse diode $I_F = f(V_F)$
 parameter: T_J

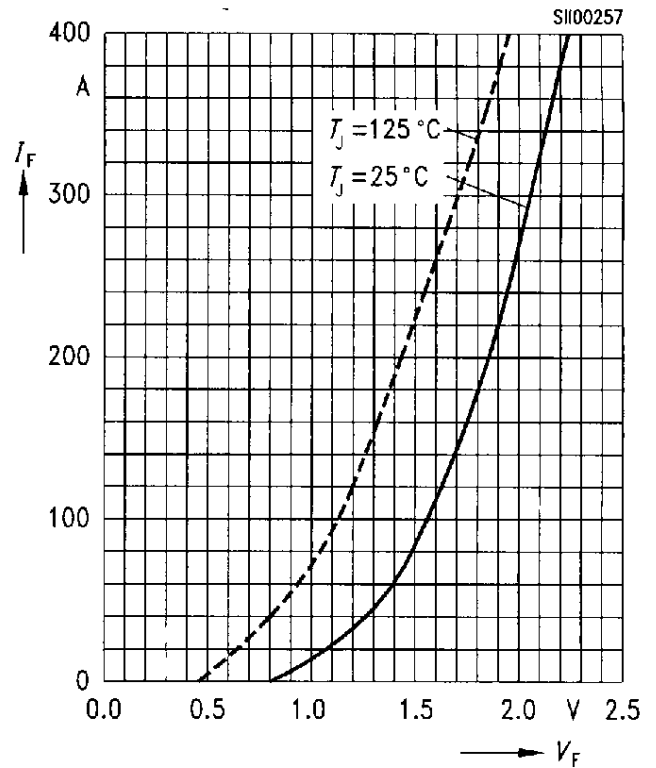

Typ. switching time $t = f(R_G)$
 Inductive load, parameter: $T_J = 125\text{ °C}$
 $V_{CE} = 600\text{ V}$, $V_{GE} = \pm 15\text{ V}$, $I_C = 200\text{ A}$

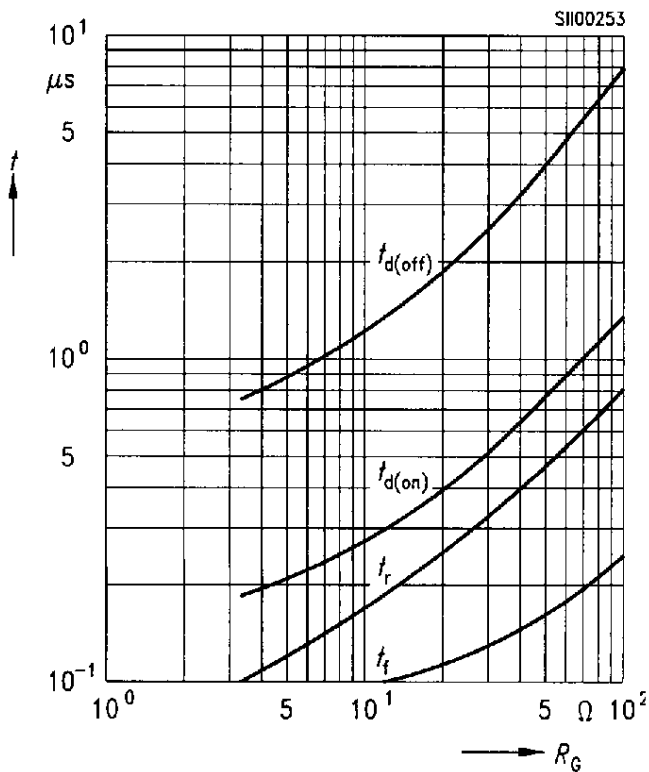

Typ. switching time $t = f(I_C)$
 Inductive load, parameter: $T_J = 125\text{ °C}$
 $V_{CE} = 600\text{ V}$, $V_{GE} = \pm 15\text{ V}$, $R_G = 3.3\text{ Ω}$

