

Speaker Amplifier

IL5009

The IL5009 is a monolithic integrated circuit designed for speaker amp.

FEATURES

- Operating supply voltage range : $V_{cc} = 1.5V \sim 5.0V$
- Recommended operating supply voltage : $V_{cc} = 3V$
- Low quiescent : $I_{cc} = 3.9mA$
- Package is compact.

APPLICATION

- Telephone set

MAXIMUM RATINGS

Characteristics	Symbol	Rating	Unit
Supply Voltage	V_{cc}	10	V
Power Dissipation	P_D	800	mW
Operating Temperature	T_{opr}	-20 ~ +60	°C
Storage Temperature	T_{str}	-55 ~ +150	°C

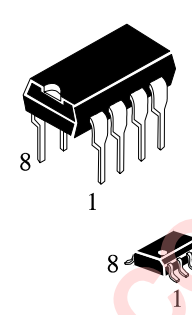

N SUFFIX
PLASTIC

D SUFFIX
SOIC

ORDERING INFORMATION
 IL5009N Plastic
 IL5009D SOIC
 $T_A = -20^\circ$ to 60° C for package

BLOCK DIAGRAM & APPLICATION CIRCUIT

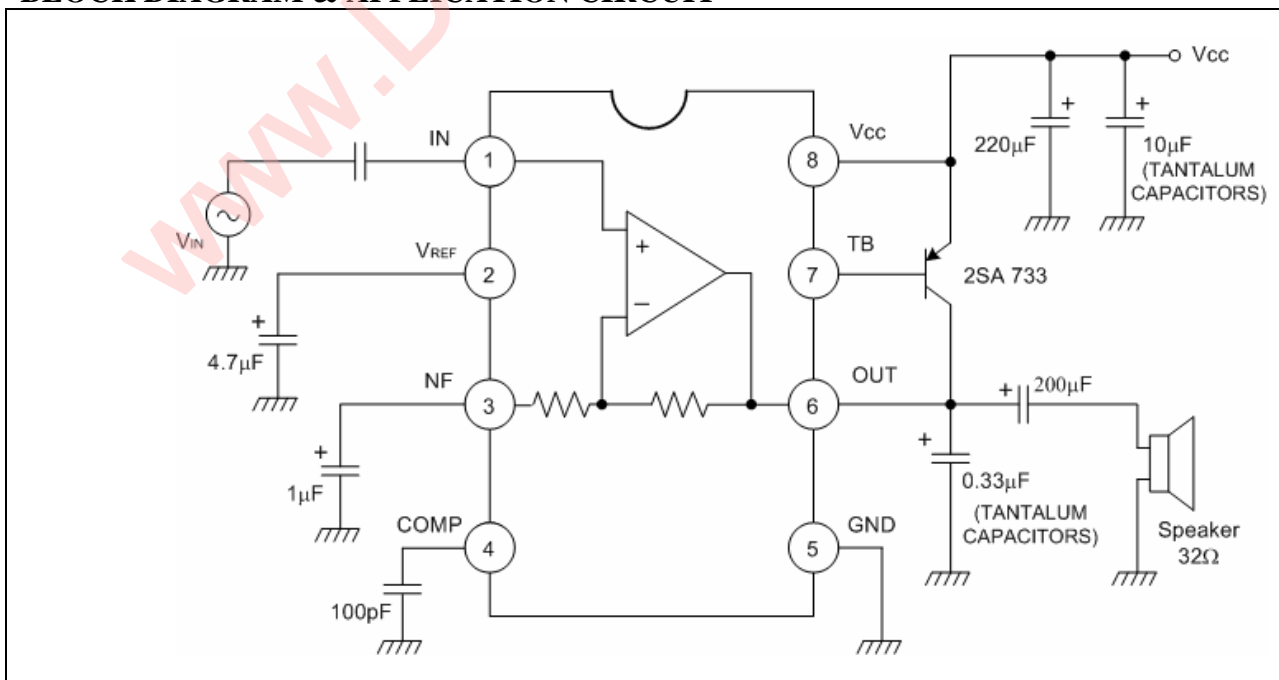

ELECTRICAL DC CHARACTERISTICS

(Pin Voltage at $V_{CC} = 3V$ and no input signal)

Pin No.	Symbol	Typical Value	Unit	Pin No	Symbol	Typical Value	Unit
1	V_1	1.4	V	5	V_5	0	V
2	V_2	1.4	V	6	V_6	1.5	V
3	V_3	1.4	V	7	V_7	2.3	V
4	V_4	1.3	V	8	V_8	3.0	V

ELECTRICAL AC CHARACTERISTICS

(Unless otherwise specified, $V_{CC} = 3V$, $f = 1KHz$, $V_{IN} = 20mV_{rms}$, $R_L = 32\Omega$, $T_a = 25^\circ C$)

Characteristic	Symbol	Test condition	Min.	Typ.	Max.	Unit
Quiescent Current	I_{CCO1}	$V_{CC} = 1.5V$		3.1		mA
	I_{CCO2}	$V_{CC} = 3.0V$		3.9		mA
	I_{CCO3}	$V_{CC} = 5.0V$		4.9		mA
Close Loop Voltage Gain	G_V			27		dB
Maximum Output Voltage	V_{OM}	THD = 10%		1.0		V _{rms}
Total Harmonic Distortion	THD	$V_{IN} = 40m V_{rms}$		0.6		%
Output noise Voltage	V_{NO}	$V_{IN} = 0$		200		μV_{rms}
Input Resistance	R_{IN}			15		K Ω

TYPICAL PERFORMANCE CHARACTERISTICS

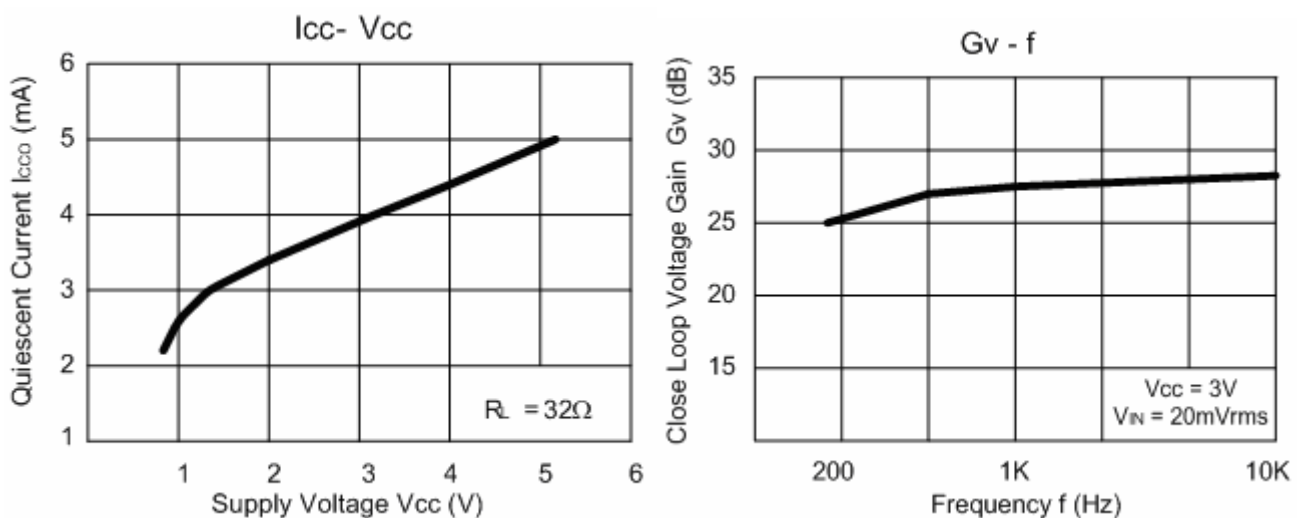

**N SUFFIX PLASTIC DIP
(MS - 001BA)**

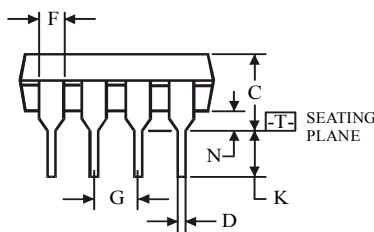
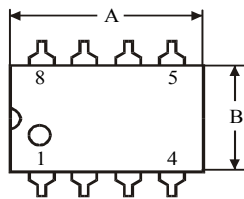
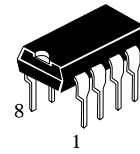

$\oplus 0.25 (0.010) \text{ (M) T}$

Symbol	Dimension, mm	
	MIN	MAX
A	8.51	10.16
B	6.1	7.11
C		5.33
D	0.36	0.56
F	1.14	1.78
G	2.54	
H	7.62	
J	0°	10°
K	2.92	3.81
L	7.62	8.26
M	0.2	0.36
N	0.38	

NOTES:

- Dimensions "A", "B" do not include mold flash or protrusions.
Maximum mold flash or protrusions 0.25 mm (0.010) per side.

**D SUFFIX SOIC
(MS - 012AA)**

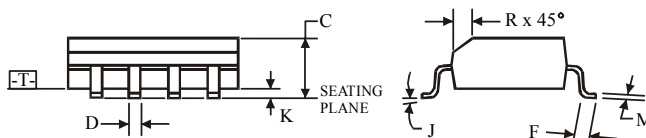
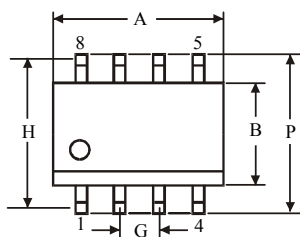
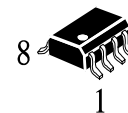

$\oplus 0.25 (0.010) \text{ (M) T C (M)}$

Symbol	Dimension, mm	
	MIN	MAX
A	4.8	5
B	3.8	4
C	1.35	1.75
D	0.33	0.51
F	0.4	1.27
G	1.27	
H	5.72	
J	0°	8°
K	0.1	0.25
M	0.19	0.25
P	5.8	6.2
R	0.25	0.5

NOTES:

- Dimensions A and B do not include mold flash or protrusion.
- Maximum mold flash or protrusion 0.15 mm (0.006) per side for A; for B - 0.25 mm (0.010) per side.