

P-Channel Enhancement Mode Power MOSFET

 Lead(Pb)-Free

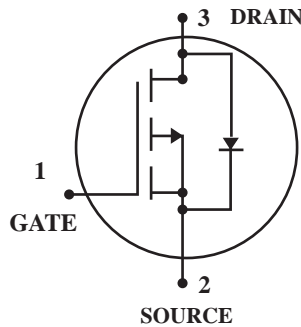

DRAIN CURRENT
-2.3 AMPERES

DRAIN SOURCE VOLTAGE
-20 VOLTAGE

Features:

- *Super High Dense Cell Design For Low $R_{DS(ON)}$
 $R_{DS(ON)} < 100m\Omega @ V_{GS} = -4.5V$
- *Rugged and Reliable
- *Simple Drive Requirement
- *SOT-23 Package

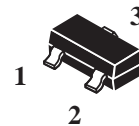

SOT-23

Applications

- *Power Management in Notebook Computer
- *Portable Equipment
- *Battery Powered System

Maximum Ratings ($T_A = 25^\circ C$ Unless Otherwise Specified)

Rating	Symbol	Value	Unit
Drain-Source Voltage	V_{DS}	-20	V
Gate-Source Voltage	V_{GS}	± 8	
Continuous Drain Current ³	I_D	-2.3	A
Pulsed Drain Current ^{1,2}	I_{DM}	-8	A
Total Power Dissipation ($T_A = 25^\circ C$) ($T_A = 75^\circ C$)	P_D	0.9 0.57	W
Maximum Junction-ambient ³	$R_{\theta JA}$	140	$^\circ C/W$
Maximum Junction-case	$R_{\theta JC}$	100	$^\circ C/W$
Ambient Temperature	T_a	150	$^\circ C$
Case Temperature	T_c	150	$^\circ C$
Operating Junction Temperature Range	T_J	150	$^\circ C$
Storage Temperature Range	T_{stg}	-55 ~ +150	$^\circ C$

Device Marking

WTC2301 = 01

Electrical Characteristics ($T_A = 25^\circ\text{C}$ Unless otherwise noted)

Characteristic	Symbol	Min	Typ	Max	Unit
----------------	--------	-----	-----	-----	------

Static

Drain-Source Breakdown Voltage $V_{GS}=0, I_D=-250\mu\text{A}$	$V_{(BR)DSS}$	-20	-	-	V
Gate-Source Threshold Voltage $V_{DS}=V_{GS}, I_D=-250\mu\text{A}$	$V_{GS(Th)}$	-0.45	-	-0.95	
Gate-Source Leakage Current $V_{GS} = \pm 8\text{V}$	I_{GSS}	-	-	± 100	nA
Drain-Source Leakage Current ($T_j=25^\circ\text{C}$) $V_{DS}=-9.6\text{V}, V_{GS}=0$	I_{DSS}	-	-	-1	μA
Drain-Source On-Resistance ² $V_{GS}=-4.5\text{V}, I_D=-2.8\text{A}$ $V_{GS}=-2.5\text{V}, I_D=-2.0\text{A}$	$R_{DS(on)}$	-	69 83	100 150	$\text{m}\Omega$
Forward Transconductance $V_{DS}=-5.0\text{V}, I_D=-4.0\text{A}$	g_{fs}	-	6.5	-	S

Dynamic

Input Capacitance $V_{GS}=0\text{V}, V_{DS}=-6\text{V}, f=1.0\text{MHz}$	C_{iss}	-	882.51	-	pF
Output Capacitance $V_{GS}=0\text{V}, V_{DS}=-6\text{V}, f=1.0\text{MHz}$	C_{oss}	-	145.54	-	
Reverse Transfer Capacitance $V_{GS}=0\text{V}, V_{DS}=-6\text{V}, f=1.0\text{MHz}$	C_{rss}	-	97.26	-	

Switching

Turn-on Delay Time ² $V_{DD}=-6V, V_{GEN}=-4.5V, I_D=-1A, R_L=6\Omega, R_G=6\Omega$	$t_d(\text{on})$	-	17.28	-	ns
Rise Time $V_{DD}=-6V, V_{GEN}=-4.5V, I_D=-1A, R_L=6\Omega, R_G=6\Omega$	t_r	-	3.73	-	
Turn-off Delay Time $V_{DD}=-6V, V_{GEN}=-4.5V, I_D=-1A, R_L=6\Omega, R_G=6\Omega$	$t_d(\text{off})$	-	36.05	-	
Fall Time $V_{DD}=-6V, V_{GEN}=-4.5V, I_D=-1A, R_L=6\Omega, R_G=6\Omega$	t_f	-	6.19	-	
Total Gate Charge ² $V_{DS}=-6.0V, V_{GS}=-4.5V, I_D=-2.8A$	Q_g	-	15.23	-	nC
Gate-Source Charge $V_{DS}=-6.0V, V_{GS}=-4.5V, I_D=-2.8A$	Q_{gs}	-	5.49	-	
Gate-Drain Change $V_{DS}=-6.0V, V_{GS}=-4.5V, I_D=-2.8A$	Q_{gd}	-	2.74	-	

Source-Drain Diode Characteristics

Forward On Voltage ² $V_{GS}=0V, I_S=-0.75A, T_j=25^\circ\text{C}$	V_{SD}	-	-0.8	-1.2	V
Continuous Source Current(Body Diode)	I_S	-	-	-2.4	A

- Note: 1. Pulse width limited by Max, junction temperature.
 2. pulse width $\leq 300\mu\text{s}$, duty cycle $\leq 2\%$.
 3. Surface mounted on 1 in² copper pad of FR4 board; 270°C/W when mounted on min, copper pad.

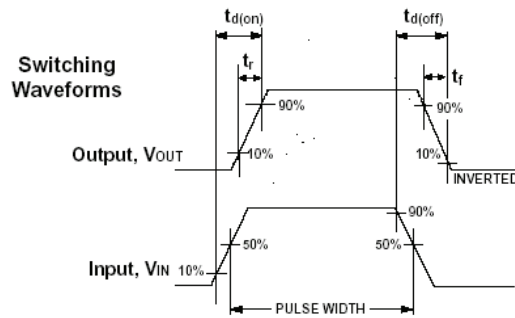
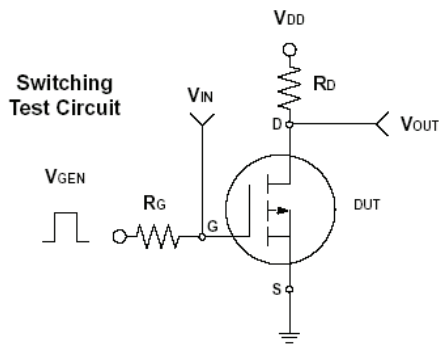

Typical Electrical Characteristics

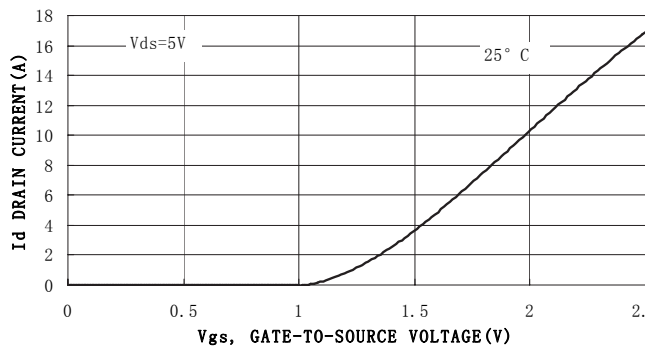

Figure 1. Transfer Characteristics

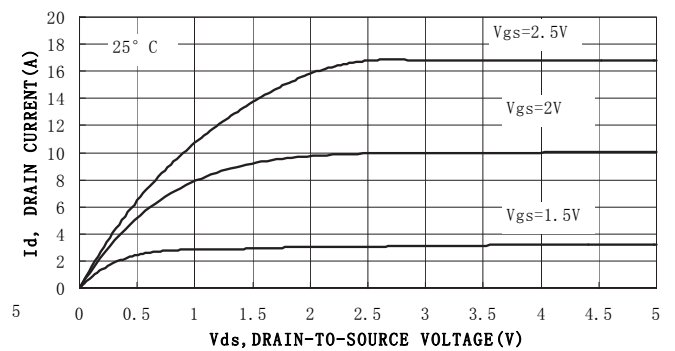

Figure 2. On-Region Characteristics

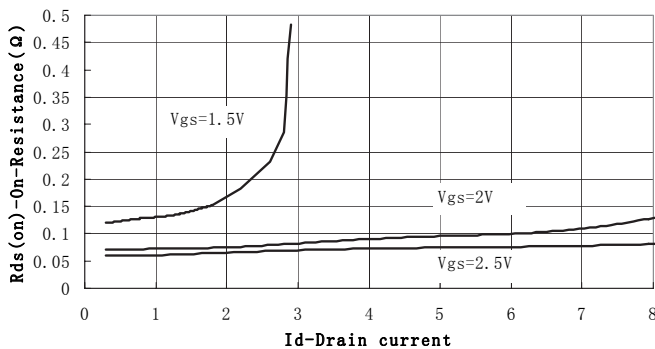

Figure 3. On-Resistance versus Drain Current

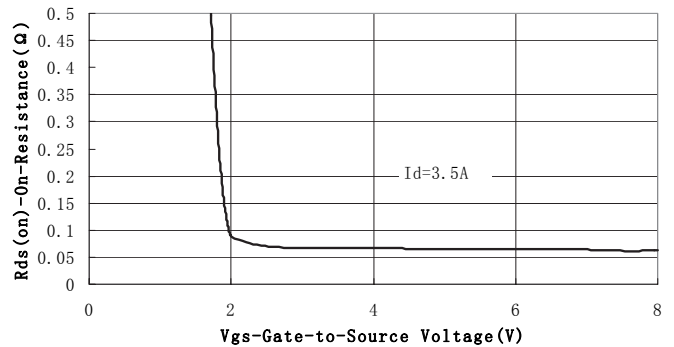

Figure 4. On-Resistance vs. Gate-to-Source Voltage

Typical Electrical Characteristics

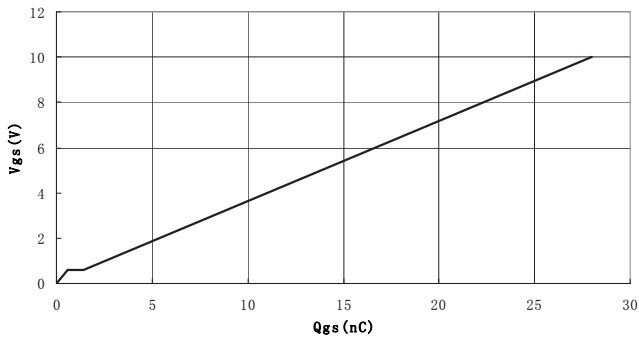

Figure 5. Gate Charge

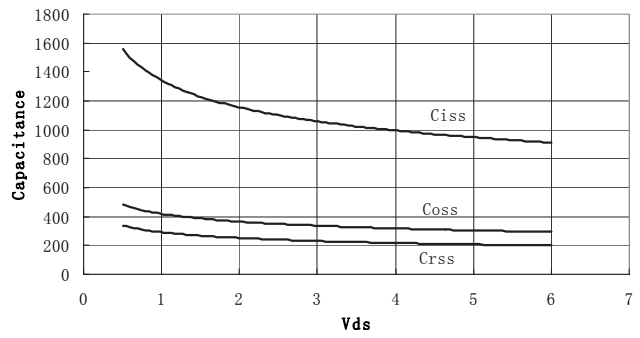

Figure 6. Capacitance

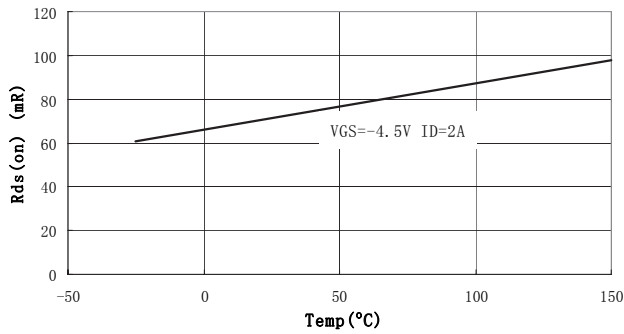

Figure 7. On-Resistance Vs. Junction Temperature

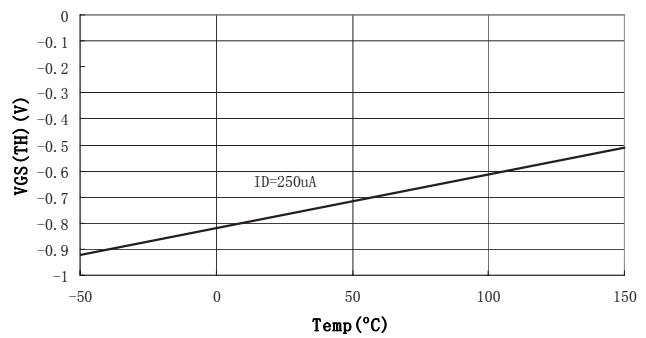

Figure 8. Vth Vs. Junction Temperature

SOT-23 Outline Dimension

