

8M-WORD BY 64-BIT

SYNCHRONOUS DYNAMIC RAM MODULE (SO DIMM)

Description

The MC-458CD64S is a 8,388,608 words by 64 bits synchronous dynamic RAM module (Small Outline DIMM) on which 8 pieces of 64M SDRAM: μ PD4564163 (Revision E) are assembled.

This module provides high density and large quantities of memory in a small space without utilizing the surface-mounting technology on the printed circuit board.

Decoupling capacitors are mounted on power supply line for noise reduction.

Features

- 8,388,608 words by 64 bits organization
- Clock frequency and Clock access time

Family	/CAS latency	Clock frequency (MAX.)	Clock access time (MAX.)	Power consumption (MAX.)	
				Active	Standby
MC-458CD64S-A80	CL = 3	125 MHz	6 ns	3,168 mW	(CMOS level input)
	CL = 2	100 MHz	6 ns	2,736 mW	
MC-458CD64S-A10	CL = 3	100 MHz	6 ns	2,736 mW	
	CL = 2	77 MHz	7 ns	2,232 mW	
MC-458CD64S-A10B	CL = 3	100 MHz	7 ns	2,736 mW	
	CL = 2	67 MHz	8 ns	1,944 mW	

- Fully Synchronous Dynamic RAM, with all signals referenced to a positive clock edge
- Pulsed interface
- Possible to assert random column address in every cycle
- Quad internal banks controlled by BA0, BA1 (Bank Select)
- Programmable burst-length (1, 2, 4, 8 and Full Page)
- Programmable wrap sequence (Sequential / Interleave)
- Programmable /CAS latency (2, 3)
- Automatic precharge and controlled precharge
- CBR (Auto) refresh and self refresh
- Single 3.3V \pm 0.3V power supply
- LVTTTL compatible
- 4,096 refresh cycles/64 ms
- Burst termination by Burst Stop command and Precharge command
- 144-pin small outline dual in-line memory module (Pin pitch = 0.8 mm)
- Unbuffered type
- Serial PD

The information in this document is subject to change without notice.

Ordering Information

Part number	Clock frequency MHz (MAX.)	Package	Mounted devices
MC-458CD64S-A80	125 MHz	144-pin Small Outline DIMM (Socket Type) Edge connector : Gold plated 26.67 mm (1.05 inch) height	8 pieces of μ PD4564163G5 (Revision E) (400 mil TSOP (II))
MC-458CD64S-A10	100 MHz		
MC-458CD64S-A10B	100 MHz		
MC-458CD64S-A10BL	100 MHz		

Pin Configuration

144-pin Dual In-line Memory Module Socket Type (Edge connector : Gold plated)

[MC-458CD64S]

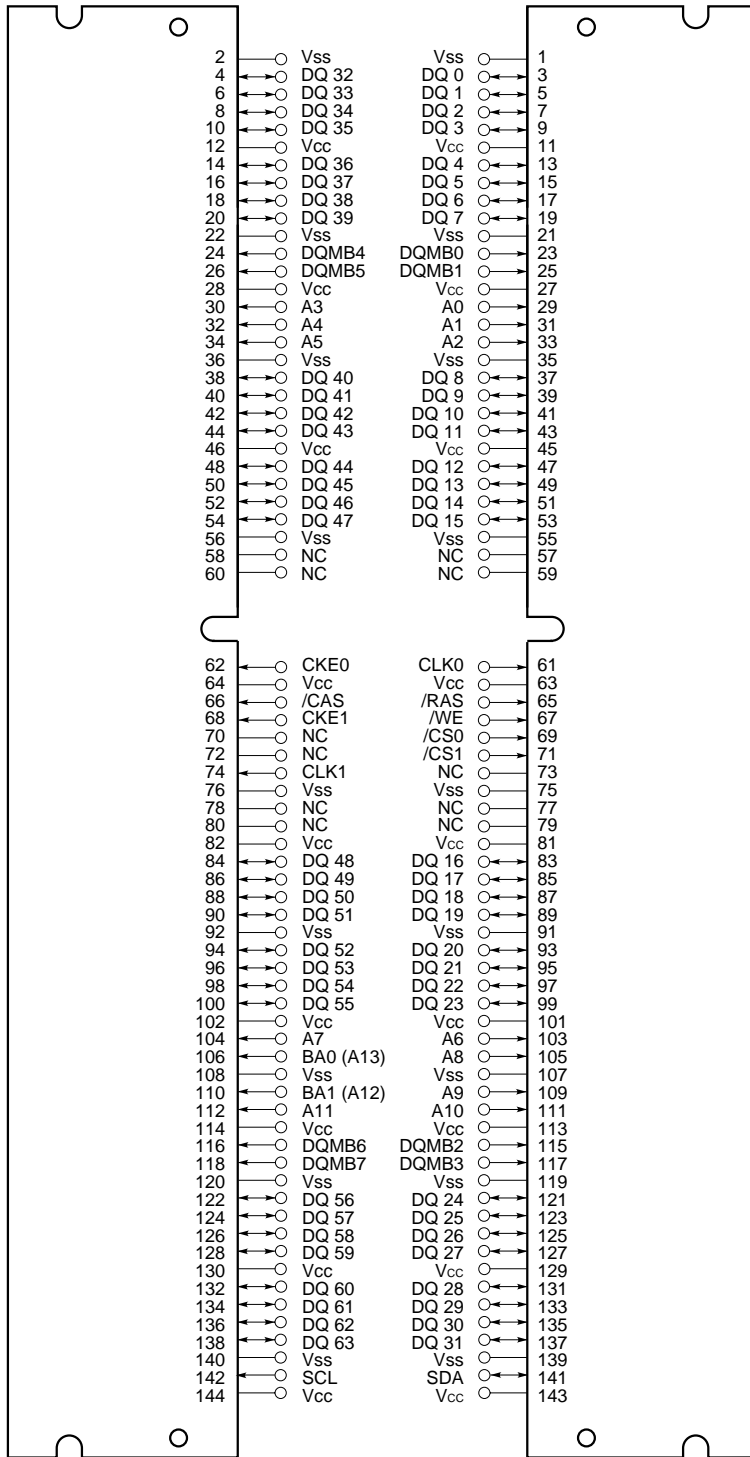

/xxx indicates active low signal.

A0 - A11 : Address Inputs

[Row: A0 - A11, Column: A0 - A7]

BA0 (A13),

BA1 (A12) : SDRAM Bank Select

DQ0 - DQ63 : Data Inputs/Outputs

CLK0, CLK1 : Clock Input

CKE0, CKE1 : Clock Enable Input

/CS0, /CS1 : Chip Select Input

/RAS : Row Address Strobe

/CAS : Column Address Strobe

/WE : Write Enable

DQMB0 - DQMB7 : DQ Mask Enable

SDA : Serial Data I/O for PD

SCL : Clock Input for PD

Vcc : Power Supply

Vss : Ground

NC : No Connection

Block Diagram

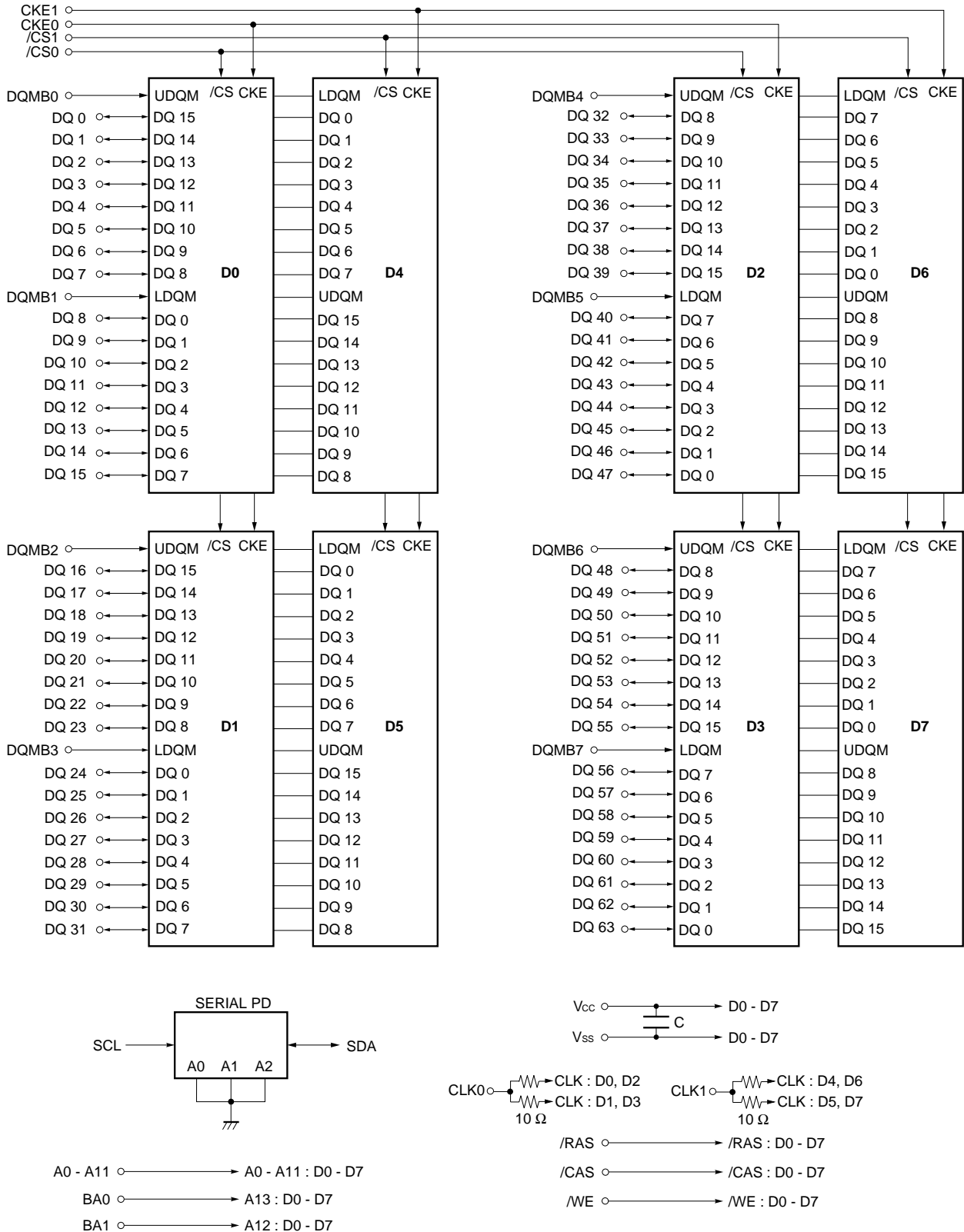

Remark D0 - D7 : μ PD4564163 (Revision E) (1M words x 16 bits x 4 banks)

Electrical Specifications

- All voltages are referenced to V_{SS} (GND).
- After power up, wait more than 100 μs and then, execute power on sequence and auto refresh before proper device operation is achieved.

Absolute Maximum Ratings

Parameter	Symbol	Condition	Rating	Unit
Voltage on power supply pin relative to GND	V _{CC}		-0.5 to +4.6	V
Voltage on input pin relative to GND	V _T		-0.5 to +4.6	V
Short circuit output current	I _O		50	mA
Power dissipation	P _D		8	W
Operating ambient temperature	T _A		0 to +70	°C
Storage temperature	T _{stg}		-55 to +125	°C

Caution Exposing the device to stress above those listed in Absolute Maximum Ratings could cause permanent damage. The device is not meant to be operated under conditions outside the limits described in the operational section of this specification. Exposure to Absolute Maximum Rating conditions for extended periods may affect device reliability.

Recommended Operating Conditions

Parameter	Symbol	Condition	MIN.	TYP.	MAX.	Unit
Supply voltage	V _{CC}		3.0	3.3	3.6	V
High level input voltage	V _{IH}		2.0		V _{CC} + 0.3	V
Low level input voltage	V _{IL}		-0.3		+0.8	V
Operating ambient temperature	T _A		0		70	°C

Capacitance (T_A = 25 °C, f = 1 MHz)

Parameter	Symbol	Test condition	MIN.	TYP.	MAX.	Unit
Input capacitance	C11	A0 - A11, BA0(A13), BA1(A12), /RAS, /CAS, /WE			60	pF
	C12	CLK0, CLK1			30	
	C13	CKE0, CKE1			30	
	C14	/CS0, /CS1			30	
	C15	DQMB0 - DQMB7			20	
Data input/output capacitance	C _{I/O}	DQ0 - DQ63			20	pF

DC Characteristics (Recommended Operating Conditions unless otherwise noted)

Parameter	Symbol	Test condition			MIN.	MAX.	Unit	Notes
Operating current	I _{CC1}	Burst length = 1, t _{RC} ≥ t _{RC(MIN.)}	/CAS latency = 2	-A80		460	mA	1
				-A10		420		
				-A10B		380		
			/CAS latency = 3	-A80		560		
				-A10		460		
				-A10B		460		
Precharge standby current in power down mode	I _{CC2P}	CKE ≤ V _{IL(MAX.)} , t _{CK} = 15 ns				8	mA	
	I _{CC2PS}	CKE ≤ V _{IL(MAX.)} , t _{CK} = ∞				4		
Precharge standby current in non power down mode	I _{CC2N}	CKE ≥ V _{IH(MIN.)} , t _{CK} = 15 ns, /CS ≥ V _{IH(MIN.)} , Input signals are changed one time during 30 ns.				160	mA	
	I _{CC2NS}	CKE ≥ V _{IH(MIN.)} , t _{CK} = ∞, Input signals are stable.				48		
Active standby current in power down mode	I _{CC3P}	CKE ≤ V _{IL(MAX.)} , t _{CK} = 15 ns				40	mA	
	I _{CC3PS}	CKE ≤ V _{IL(MAX.)} , t _{CK} = ∞				32		
Active standby current in non power down mode	I _{CC3N}	CKE ≥ V _{IH(MIN.)} , t _{CK} = 15 ns, /CS ≥ V _{IH(MIN.)} , Input signals are changed one time during 30 ns.				200	mA	
	I _{CC3NS}	CKE ≥ V _{IH(MIN.)} , t _{CK} = ∞, Input signals are stable.				80		
Operating current (Burst mode)	I _{CC4}	t _{CK} ≥ t _{CK(MIN.)} , I _O = 0 mA	/CAS latency = 2	-A80		760	mA	2
				-A10		620		
				-A10B		540		
			/CAS latency = 3	-A80		880		
				-A10		760		
				-A10B		760		
Refresh current	I _{CC5}	t _{RC} ≥ t _{RC(MIN.)}	/CAS latency = 2	-A80		620	mA	3
				-A10		620		
				-A10B		520		
			/CAS latency = 3	-A80		640		
				-A10		640		
				-A10B		560		
Self refresh current	I _{CC6}	CKE ≤ 0.2 V	-A**		8	mA		
			-A**L		3.2			
Input leakage current	I _{I(L)}	V _I = 0 to 3.6 V, All other pins not under test = 0 V			-8	+8	μA	
Output leakage current	I _{O(L)}	D _{OUT} is disabled, V _O = 0 to 3.6 V			-3	+3	μA	
High level output voltage	V _{OH}	I _O = -4.0 mA			2.4		V	
Low level output voltage	V _{OL}	I _O = +4.0 mA				0.4	V	

- Notes**
- I_{CC1} depends on output loading and cycle rates. Specified values are obtained with the output open. In addition to this, I_{CC1} is measured on condition that addresses are changed only one time during t_{CK(MIN.)}.
 - I_{CC4} depends on output loading and cycle rates. Specified values are obtained with the output open. In addition to this, I_{CC4} is measured on condition that addresses are changed only one time during t_{CK(MIN.)}.
 - I_{CC5} is measured on condition that addresses are changed only one time during t_{CK(MIN.)}.

AC Characteristics (Recommended Operating Conditions unless otherwise noted)

AC Characteristics Test Conditions

- AC measurements assume $t_{\tau} = 1$ ns.
- Reference level for measuring timing of input signals is 1.4 V. Transition times are measured between V_{IH} and V_{IL} .
- If t_{τ} is longer than 1 ns, reference level for measuring timing of input signals is $V_{IH(MIN.)}$ and $V_{IL(MAX.)}$.
- An access time is measured at 1.4 V.

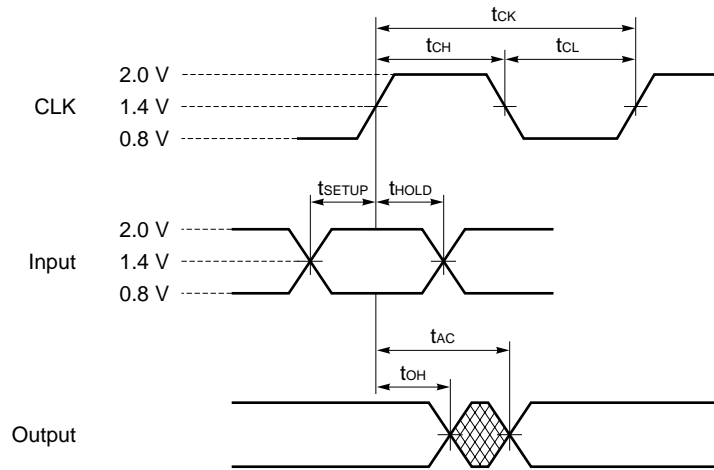

Synchronous Characteristics

Parameter		Symbol	-A80		-A10		-A10B		Unit	Note
			MIN.	MAX.	MIN.	MAX.	MIN.	MAX.		
Clock cycle time	/CAS latency = 3	t _{CK3}	8	(125 MHz)	10	(100 MHz)	10	(100 MHz)	ns	
	/CAS latency = 2	t _{CK2}	10	(100 MHz)	13	(77 MHz)	15	(67 MHz)	ns	
Access time from CLK	/CAS latency = 3	t _{AC3}		6		6		7	ns	1
	/CAS latency = 2	t _{AC2}		6		7		8	ns	1
CLK high level width		t _{CH}	3		3		3.5		ns	
CLK low level width		t _{CL}	3		3		3.5		ns	
Data-out hold time		t _{OH}	3		3		3		ns	1
Data-out low-impedance time		t _{LZ}	0		0		0		ns	
Data-out high-impedance time	/CAS latency = 3	t _{HZ3}	3	6	3	6	3	7	ns	
	/CAS latency = 2	t _{HZ2}	3	6	3	7	3	8	ns	
Data-in setup time		t _{DS}	2		2		2.5		ns	
Data-in hold time		t _{DH}	1		1		1		ns	
Address setup time		t _{AS}	2		2		2.5		ns	
Address hold time		t _{AH}	1		1		1		ns	
CKE setup time		t _{CKS}	2		2		2.5		ns	
CKE hold time		t _{CKH}	1		1		1		ns	
CKE setup time (Power down exit)		t _{CKSP}	2		2		2.5		ns	
Command (/CS0, /CS1, /RAS, /CAS, /WE, DQMB0 - DQMB7) setup time		t _{CMS}	2		2		2.5		ns	
Command (/CS0, /CS1, /RAS, /CAS, /WE, DQMB0 - DQMB7) hold time		t _{CMH}	1		1		1		ns	

Note 1. Output load

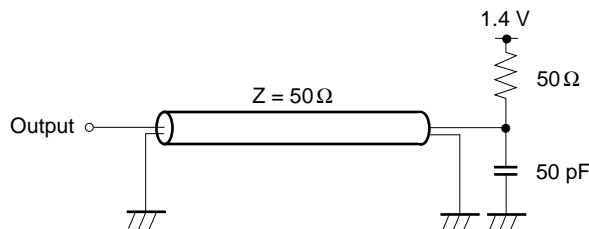

Asynchronous Characteristics

Parameter	Symbol	-A 80		-A 10		-A 10B		Unit	Note
		MIN.	MAX.	MIN.	MAX.	MIN.	MAX.		
ACT to REF/ACT command period (Operation)	t _{RC}	70		70		90		ns	
REF to REF/ACT command period (Refresh)	t _{RC1}	70		70		90		ns	
ACT to PRE command period	t _{RAS}	48	120,000	50	120,000	60	120,000	ns	
PRE to ACT command period	t _{RP}	20		20		30		ns	
Delay time ACT to READ/WRITE command	t _{RCD}	20		20		30		ns	
ACT(one) to ACT(another) command period	t _{RRD}	16		20		20		ns	
Data-in to PRE command period	t _{DPL}	8		10		10		ns	
Data-in to ACT(REF) command period (Auto precharge)	/CAS latency = 3 t _{DAL3}	1CLK+20		1CLK+20		1CLK+30		ns	
	/CAS latency = 2 t _{DAL2}	1CLK+20		1CLK+20		1CLK+30		ns	
Mode register set cycle time	t _{RSC}	2		2		2		CLK	
Transition time	t _r	0.5	30	1	30	1	30	ns	
Refresh time (4,096 refresh cycles)	t _{REF}		64		64		64	ms	

Serial PD

(1/2)

Byte No.	Function Described	Hex	Bit 7	Bit 6	Bit 5	Bit 4	Bit 3	Bit 2	Bit 1	Bit 0	Notes
0	Defines the number of bytes written into serial PD memory	80H	1	0	0	0	0	0	0	0	128 bytes
1	Total number of bytes of serial PD memory	08H	0	0	0	0	1	0	0	0	256 bytes
2	Fundamental memory type	04H	0	0	0	0	0	1	0	0	SDRAM
3	Number of rows	0CH	0	0	0	0	1	1	0	0	12 rows
4	Number of columns	08H	0	0	0	0	1	0	0	0	8 columns
5	Number of banks	02H	0	0	0	0	0	0	1	0	2 banks
6	Data width	40H	0	1	0	0	0	0	0	0	64 bits
7	Data width (continued)	00H	0	0	0	0	0	0	0	0	0
8	Voltage interface	01H	0	0	0	0	0	0	0	1	LVTTTL
9	CL = 3 Cycle time	-A80	80H	1	0	0	0	0	0	0	8 ns
		-A10	A0H	1	0	1	0	0	0	0	10 ns
		-A10B/-A10BL	A0H	1	0	1	0	0	0	0	10 ns
10	CL =3 Access time	-A80	60H	0	1	1	0	0	0	0	6 ns
		-A10	60H	0	1	1	0	0	0	0	6 ns
		-A10B/-A10BL	70H	0	1	1	1	0	0	0	7 ns
11	DIMM configuration type	00H	0	0	0	0	0	0	0	0	None
12	Refresh rate/type	80H	1	0	0	0	0	0	0	0	Normal
13	SDRAM width	10H	0	0	0	1	0	0	0	0	×16
14	Error checking SDRAM width	00H	0	0	0	0	0	0	0	0	None
15	Minimum clock delay	01H	0	0	0	0	0	0	0	1	1 clock
16	Burst length supported	8FH	1	0	0	0	1	1	1	1	1, 2, 4, 8, F
17	Number of banks on each SDRAM	04H	0	0	0	0	0	1	0	0	4 banks
18	/CAS latency supported	06H	0	0	0	0	0	1	1	0	2, 3
19	/CS latency supported	01H	0	0	0	0	0	0	0	1	0
20	/WE latency supported	01H	0	0	0	0	0	0	0	1	0
21	SDRAM module attributes	00H	0	0	0	0	0	0	0	0	
22	SDRAM device attributes : General	0EH	0	0	0	0	1	1	1	0	
23	CL = 2 Cycle time	-A80	A0H	1	0	1	0	0	0	0	10 ns
		-A10	D0H	1	1	0	1	0	0	0	13 ns
		-A10B/-A10BL	F0H	1	1	1	1	0	0	0	15 ns
24	CL = 2 Access time	-A80	60H	0	1	1	0	0	0	0	6 ns
		-A10	70H	0	1	1	1	0	0	0	7 ns
		-A10B/-A10BL	80H	1	0	0	0	0	0	0	8 ns
25-26		00H	0	0	0	0	0	0	0	0	
27	t _{RP} (MIN.)	-A80	14H	0	0	0	1	0	1	0	20 ns
		-A10	14H	0	0	0	1	0	1	0	20 ns
		-A10B/-A10BL	1EH	0	0	0	1	1	1	1	0
28	t _{RRD} (MIN.)	-A80	10H	0	0	0	1	0	0	0	16 ns
		-A10	14H	0	0	0	1	0	1	0	20 ns
		-A10B/-A10BL	14H	0	0	0	1	0	1	0	20 ns
29	t _{RCD} (MIN.)	-A80	14H	0	0	0	1	0	1	0	20 ns
		-A10	14H	0	0	0	1	0	1	0	20 ns
		-A10B/-A10BL	1EH	0	0	0	1	1	1	1	0
30	t _{RAS} (MIN.)	-A80	30H	0	0	1	1	0	0	0	48 ns
		-A10	32H	0	0	1	1	0	0	1	50 ns
		-A10B/-A10BL	3CH	0	0	1	1	1	1	0	0
31	Module bank density	08H	0	0	0	0	1	0	0	0	32M bytes

(2/2)

Byte No.	Function Described	Hex	Bit 7	Bit 6	Bit 5	Bit 4	Bit 3	Bit 2	Bit 1	Bit 0	Notes	
32	Command and add setup time	-A80	20H	0	0	1	0	0	0	0	2 ns	
		-A10	20H	0	0	1	0	0	0	0	2 ns	
		-A10B/-A10BL	00H	0	0	0	0	0	0	0		
33	Command and add hold time	-A80	10H	0	0	0	1	0	0	0	1 ns	
		-A10	10H	0	0	0	1	0	0	0	1 ns	
		-A10B/-A10BL	00H	0	0	0	0	0	0	0		
34	Data signal input setup time	-A80	20H	0	0	1	0	0	0	0	2 ns	
		-A10	20H	0	0	1	0	0	0	0	2 ns	
		-A10B/-A10BL	00H	0	0	0	0	0	0	0		
35	Data signal input hold time	-A80	10H	0	0	0	1	0	0	0	1 ns	
		-A10	10H	0	0	0	1	0	0	0	1 ns	
		-A10B/-A10BL	00H	0	0	0	0	0	0	0		
36-61		00H	0	0	0	0	0	0	0	0		
62	SPD revision	-A80	12H	0	0	0	1	0	0	1	0	1.2
		-A10	12H	0	0	0	1	0	0	1	0	1.2
		-A10B/-A10BL	01H	0	0	0	0	0	0	0	1	1
63	Checksum for bytes 0 - 62	-A80	DFH	1	1	0	1	1	1	1	1	
		-A10	45H	0	1	0	0	0	1	0	1	
		-A10B/-A10BL	32H	0	0	1	1	0	0	1	0	
64-71	Manufacture's JEDEC ID code											
72	Manufacturing location											
73-90	Manufacture's P/N											
91-92	Revision code											
93-94	Manufacturing date											
95-98	Assembly serial number											
99-125	Mfg specific											
126	Intel specification frequency	-A80	64H	0	1	1	0	0	1	0	0	100 MHz
		-A10	64H	0	1	1	0	0	1	0	0	100 MHz
		-A10B/-A10BL	66H	0	1	1	0	0	1	1	0	66 MHz
127	Intel specification /CAS latency support	-A80	C7H	1	1	0	0	0	1	1	1	
		-A10	C5H	1	1	0	0	0	1	0	1	
		-A10B/-A10BL	06H	0	0	0	0	0	1	1	0	

Timing Chart

Refer to the **SYNCHRONOUS DRAM MODULE TIMING CHART Information (M13348XJ)**.

★ Package Drawing

144 PIN DUAL IN-LINE MODULE (SOCKET TYPE)

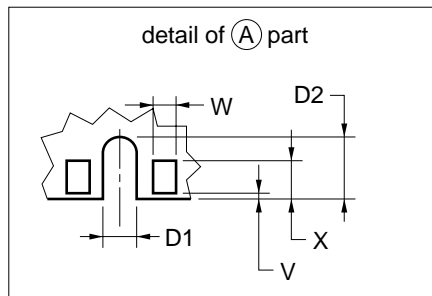
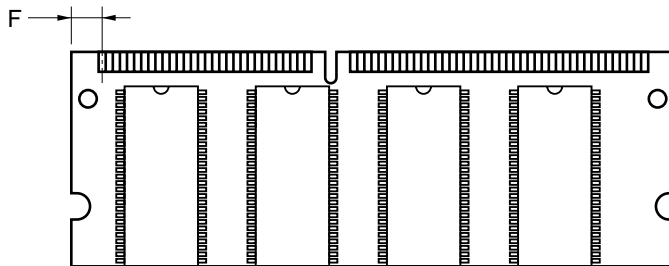
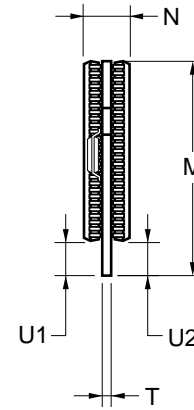
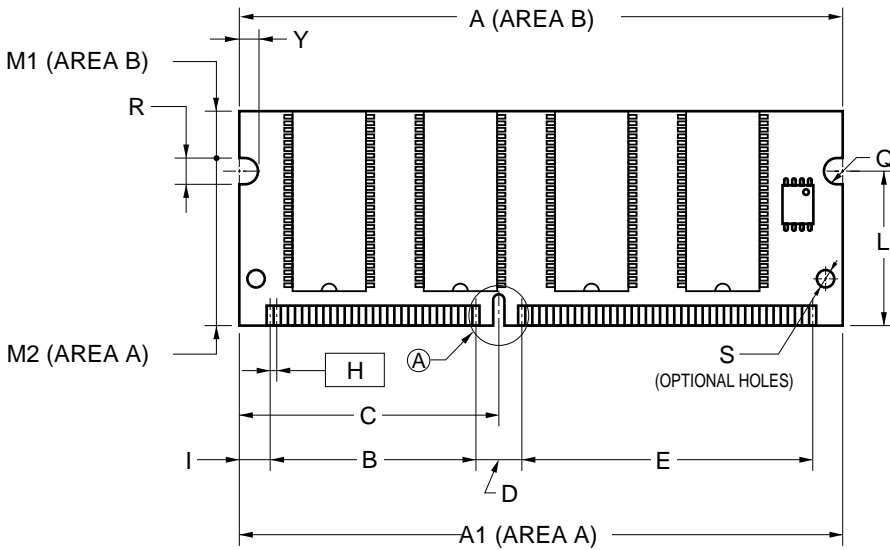

ITEM	MILLIMETERS
A	67.6
A1	67.6±0.15
B	23.2
C	29.0
D	4.6
D1	1.5±0.10
D2	4.0
E	32.8
F	3.7
H	0.8(T.P)
I	3.3
L	20.0
M	26.67±0.15
M1	4.67
M2	22.0
N	3.8 MAX.
Q	R2.0
R	4.0±0.10
S	φ1.8
T	1.0±0.1
U1	3.2 MIN.
U2	4.0 MIN.
V	0.25 MAX.
W	0.6±0.05
X	2.55 MIN.
Y	2.0 MIN.

[MEMO]

[MEMO]

NOTES FOR CMOS DEVICES

① PRECAUTION AGAINST ESD FOR SEMICONDUCTORS

Note: Strong electric field, when exposed to a MOS device, can cause destruction of the gate oxide and ultimately degrade the device operation. Steps must be taken to stop generation of static electricity as much as possible, and quickly dissipate it once, when it has occurred. Environmental control must be adequate. When it is dry, humidifier should be used. It is recommended to avoid using insulators that easily build static electricity. Semiconductor devices must be stored and transported in an anti-static container, static shielding bag or conductive material. All test and measurement tools including work bench and floor should be grounded. The operator should be grounded using wrist strap. Semiconductor devices must not be touched with bare hands. Similar precautions need to be taken for PW boards with semiconductor devices on it.

② HANDLING OF UNUSED INPUT PINS FOR CMOS

Note: No connection for CMOS device inputs can be cause of malfunction. If no connection is provided to the input pins, it is possible that an internal input level may be generated due to noise, etc., hence causing malfunction. CMOS devices behave differently than Bipolar or NMOS devices. Input levels of CMOS devices must be fixed high or low by using a pull-up or pull-down circuitry. Each unused pin should be connected to V_{DD} or GND with a resistor, if it is considered to have a possibility of being an output pin. All handling related to the unused pins must be judged device by device and related specifications governing the devices.

③ STATUS BEFORE INITIALIZATION OF MOS DEVICES

Note: Power-on does not necessarily define initial status of MOS device. Production process of MOS does not define the initial operation status of the device. Immediately after the power source is turned ON, the devices with reset function have not yet been initialized. Hence, power-on does not guarantee out-pin levels, I/O settings or contents of registers. Device is not initialized until the reset signal is received. Reset operation must be executed immediately after power-on for devices having reset function.

CAUTION FOR HANDLING MEMORY MODULES

When handling or inserting memory modules, be sure not to touch any components on the modules, such as the memory IC, chip capacitors and chip resistors. It is necessary to avoid undue mechanical stress on these components to prevent damaging them.

When re-packing memory modules, be sure the modules are NOT touching each other. Modules in contact with other modules may cause excessive mechanical stress, which may damage the modules.

No part of this document may be copied or reproduced in any form or by any means without the prior written consent of NEC Corporation. NEC Corporation assumes no responsibility for any errors which may appear in this document.

NEC Corporation does not assume any liability for infringement of patents, copyrights or other intellectual property rights of third parties by or arising from use of a device described herein or any other liability arising from use of such device. No license, either express, implied or otherwise, is granted under any patents, copyrights or other intellectual property rights of NEC Corporation or others.

While NEC Corporation has been making continuous effort to enhance the reliability of its semiconductor devices, the possibility of defects cannot be eliminated entirely. To minimize risks of damage or injury to persons or property arising from a defect in an NEC semiconductor device, customers must incorporate sufficient safety measures in its design, such as redundancy, fire-containment, and anti-failure features.

NEC devices are classified into the following three quality grades:

"Standard", "Special", and "Specific". The Specific quality grade applies only to devices developed based on a customer designated "quality assurance program" for a specific application. The recommended applications of a device depend on its quality grade, as indicated below. Customers must check the quality grade of each device before using it in a particular application.

Standard: Computers, office equipment, communications equipment, test and measurement equipment, audio and visual equipment, home electronic appliances, machine tools, personal electronic equipment and industrial robots

Special: Transportation equipment (automobiles, trains, ships, etc.), traffic control systems, anti-disaster systems, anti-crime systems, safety equipment and medical equipment (not specifically designed for life support)

Specific: Aircrafts, aerospace equipment, submersible repeaters, nuclear reactor control systems, life support systems or medical equipment for life support, etc.

The quality grade of NEC devices is "Standard" unless otherwise specified in NEC's Data Sheets or Data Books. If customers intend to use NEC devices for applications other than those specified for Standard quality grade, they should contact an NEC sales representative in advance.

Anti-radioactive design is not implemented in this product.