

Panasonic

Digital Super Hybrid System

Operating Instructions

Model No. **KX-TD208CE**

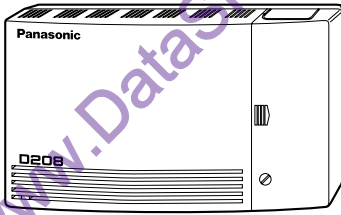

Please read this manual before using the
Digital Super Hybrid System.

Thank you for purchasing the Panasonic Telephone System.

System Components

| | Model No. | Description |
|-------------------------|--|---|
| Service Unit | KX-TD208 | Digital Super Hybrid System (Main Unit) |
| Optional Module | KX-TD20870 KX-TD20880 | 4 Extension Expansion Card 1-ISDN Line Card |
| Optional Telephone | KX-T7230 KX-T7235 KX-T7250 KX-T7425 KX-T7433 KX-T7436 KX-T7450 | Digital Proprietary Telephone with 2 line display Digital Proprietary Telephone with 6 line display Digital Proprietary Telephone Digital Proprietary Telephone Digital Proprietary Telephone with 3 line display Digital Proprietary Telephone with 6 line display Digital Proprietary Telephone |
| User-supplied Equipment | Single Line Telephone | |

- NOTICE:**
- In this manual, the suffix “CE” or “CE-B” of each model number is omitted.
 - A single line telephone is abbreviated as SLT.
 - An ISDN telephone is abbreviated as ISDN-T.
 - A digital proprietary telephone is abbreviated as DPT.
 - IBM is a registered trademark of International Business Machines Corporation.
- MS-DOS® is registered trademark of Microsoft Corporation in the United States and/or other countries.
- All other trademarks identified herein are the property of their respective owners.



73/23/EEC “Low Voltage Directive”
89/336/EEC “Electromagnetic compatibility” (Basic EMC Publication)
92/31/EEC “Electromagnetic compatibility” (Supplement)
93/68/EEC “CE Mark”
91/263/EEC “Terminal Directive”

Precautions

- Keep the unit away from heating appliances and electrical noise generating devices such as fluorescent lamps, motors and televisions. These noise sources can interfere with the performance of the Digital Super Hybrid System.
- This unit should be kept free of dust, moisture, high temperature (more than 40°C) and vibration, and should not be exposed to direct sunlight.
- Never attempt to insert wires, pins, etc. into the vents or other holes of this unit.
- If there is any trouble, disconnect the unit from the telephone line. Plug the ISDN telephone directly into the telephone line. If the ISDN telephone operates properly, do not reconnect the unit to the line until the trouble has been repaired. If the ISDN telephone does not operate properly, chances are that the trouble is in the ISDN telephone system, and not in the unit. If an ISDN telephone is not used, please consult with your dealer.
- Do not use benzine, thinner, or the like, or any abrasive powder to clean the cabinet. Wipe it with a soft cloth.

WARNING

THIS UNIT MAY ONLY BE INSTALLED AND SERVED BY QUALIFIED SERVICE PERSONNEL.

WHEN A FAILURE OCCURS WHICH RESULTS IN THE INTERNAL PARTS BECOMING ACCESSIBLE, DISCONNECT THE POWER SUPPLY CORD IMMEDIATELY AND RETURN THIS UNIT TO YOUR DEALER.

DISCONNECT THE TELECOM CONNECTION BEFORE DISCONNECTING THE POWER CONNECTION PRIOR TO RELOCATING THE EQUIPMENT, AND RECONNECT THE POWER FIRST.

THIS UNIT IS EQUIPPED WITH AN EARTHING CONTACT PLUG. FOR SAFETY REASONS THIS PLUG MUST ONLY BE CONNECTED TO AN EARTHING CONTACT SOCKET WHICH HAS BEEN INSTALLED ACCORDING TO REGULATIONS.

TO PREVENT FIRE OR SHOCK HAZARD, DO NOT EXPOSE THIS PRODUCT TO RAIN OR MOISTURE.

THE POWER SUPPLY CORD IS USED AS THE MAIN DISCONNECT DEVICE, ENSURE THAT THE SOCKET-OUTLET IS LOCATED/INSTALLED NEAR THE EQUIPMENT AND IS EASILY ACCESSIBLE.

For your future reference

SERIAL NO. _____ DATE OF PURCHASE _____
(found on the bottom of the unit)

NAME OF DEALER _____

DEALER'S ADDRESS _____

Introduction

Structure of the Manual

This manual consists of the following sections:

Section 1. System Outline

Provides general information on the system including system capacity and connection diagrams.

Section 2. Operations

Describes the features and their operations. It also provides information about the programming required, conditions and connection references for every feature.

Section 3. System Programming

Describes system management features and the steps required to assign features to extensions or to the system. Programming tables for user-programmed data are also provided.

Section 4. Installation

Contains the system installation and wiring instructions, as well as how to install the optional card.

Section 5. Appendix

Provides a tones/ring tones list, LED identification, feature number list, default values of system programming, specifications and information for system and telephone troubleshooting.

Description of Symbols Mainly Used



Additional information and conditions.



The feature or program references.

Contents

Section 1 System Outline

| | | |
|-----|---------------------------------|-----|
| 1.1 | Basic System Construction | 1-2 |
| 1.2 | System Highlights | 1-3 |

Section 2 Operations

| | | |
|-----|--|------|
| 2.1 | Before Operating | 2-2 |
| 2.2 | Initial Settings | 2-6 |
| | Customising Your Telephone Functions | 2-6 |
| | Customising the Buttons on Your Telephone | 2-9 |
| 2.3 | Making Calls | 2-12 |
| | Intercom Calling | 2-12 |
| | Outside Calling | 2-14 |
| | Quick Dialling | 2-16 |
| | Redialling | 2-21 |
| | When the Dialed Line is Busy | 2-23 |
| 2.4 | Receiving Calls | 2-26 |
| | Receiving Calls | 2-26 |
| | Picking up a Call | 2-27 |
| 2.5 | During a Conversation | 2-29 |
| | Placing a Call on Hold | 2-29 |
| | Transferring Calls | 2-33 |
| | Call Waiting | 2-35 |
| | Turning Off the Microphone | 2-37 |
| 2.6 | Others | 2-38 |
| | Paging | 2-38 |
| | Before Leaving Your Desk | 2-39 |
| | Three-Party Conversation (Conference) | 2-45 |
| | Alarm Setting (Timed Reminder) | 2-47 |
| | Turning on the Background Music (Background Music (BGM)) | 2-48 |
| | Leaving a Message Notification (Message Waiting) | 2-49 |
| | Calling with Account Codes (Account Code Entry) | 2-51 |
| | Referring to the Charges (Charge Fee Reference) | 2-53 |
| | Denying Receiving Calls | 2-56 |
| | Calling an Extension which Denies Receiving Calls (Do Not Disturb Override) | 2-59 |
| | Privacy Feature | 2-60 |
| | Doorphone Call | 2-62 |
| | Unlocking a Door (Door Opener) | 2-63 |
| | Switching the Day / Night Calling Mode (Night Service) | 2-64 |
| | Joining or Leaving a Call Distribution Group (Log In/Log Out) | 2-66 |
| | Setting the Paralleled SLT to Ring (Paralleled Telephone Connection) | 2-67 |

Contents

| | |
|---|-------------|
| Caller Identification Services (for KX-T7230/KX-T7235/ KX-T7431/KX-T7433/KX-T7436) | 2-68 |
| Cancelling the Feature Setting (Station Feature Clear)..... | 2-74 |
| ISDN Network Service Access | 2-75 |
| Selecting the CLIP/COLP numbers | 2-76 |
| 2.7 Display Operation | |
| (KX-T7235, KX-T7431, KX-T7433, KX-T7436) | 2-77 |
| Display Operation for the Features in the Idle Status | 2-79 |
| Station Speed Dialling Number/Name Assignment..... | 2-86 |
| Display Operation for FWD/DND Features (KX-T7235/KX-T7436 only) | 2-90 |
| 2.8 Manager Operations | 2-91 |
| Switching the Extension's "Class of Service" (Class of Service Switch) | 2-91 |
| Unlocking "Incoming Call Log Lock" (Incoming Call Log Lock Control)..... | 2-91 |
| Controlling "Electronic Station Lockout" Remotely (Remote Station Lock Control) | 2-92 |
| | |
| Section 3 System Programming | |
| 3.1 System Management | 3-2 |
| Accessing to Other types of network connected to the ISDN network | 3-2 |
| Automatic Route Selection (ARS) | 3-3 |
| Budget Management..... | 3-6 |
| Class of Service (COS)..... | 3-6 |
| Data Line Security..... | 3-7 |
| Direct Dialling In (DDI)..... | 3-8 |
| Direct In Lines (DIL) | 3-9 |
| Extension Group..... | 3-9 |
| EXtra Device Port (XDP)..... | 3-10 |
| Forwarding a Doorphone Call to the Outside Line..... | 3-11 |
| Host PBX Access | 3-11 |
| Integrated Services Digital Network (ISDN) | 3-12 |
| Integrated Services Digital Network (ISDN) Extension | 3-13 |
| Intercept Routing..... | 3-14 |
| Station Hunting..... | 3-15 |
| Station Message Detail Recording (SMDR) | 3-16 |
| System Data Default Set..... | 3-18 |
| System Programming with a Personal Computer | 3-18 |
| Toll Restriction..... | 3-19 |
| Toll Restriction Override by Account Code Entry | 3-23 |
| Toll Restriction Override for System Speed Dialling..... | 3-24 |
| Uniform Call Distribution (UCD) | 3-24 |

Contents

| | | |
|------------|---|-------------|
| 3.2 | Before System Programming | 3-26 |
| 3.3 | Manager Programming | 3-28 |
| | [000] Date and Time Set..... | 3-28 |
| | [001] System Speed Dialling Number Set..... | 3-28 |
| | [002] Emergency Dial Number Set | 3-29 |
| | [003] Budget Management | 3-29 |
| 3.4 | System Programming..... | 3-30 |
| | [100] Day/Night Service Starting Time..... | 3-30 |
| | [101] Account Codes | 3-30 |
| | [102] Station Hunting Type..... | 3-30 |
| | [103] System Password..... | 3-31 |
| | [104] Pulse Dial Reception Assignment..... | 3-31 |
| | [105] Automatic Door Open Assignment..... | 3-31 |
| | [107] Charge Indication Selection | 3-32 |
| | [108] Charge Verification ID Code Set | 3-32 |
| | [109] One-Touch Transfer by DSS Button Set | 3-32 |
| 3.5 | Timer Programming | 3-33 |
| | [200] Hold Recall Time | 3-33 |
| | [201] Transfer Recall Time | 3-33 |
| | [202] Call Forwarding — No Answer Time | 3-33 |
| | [203] Intercept Time | 3-34 |
| | [204] Pickup Dial Waiting Time | 3-34 |
| | [205] DTMF Sending PAUSE Time | 3-34 |
| | [206] Door Opener Time | 3-34 |
| | [207] Message Waiting Ring Interval Time | 3-35 |
| | [208] Automatic Redial Repeat Time..... | 3-35 |
| | [209] Automatic Redial Interval Time | 3-35 |
| 3.6 | TRS Programming | 3-36 |
| | [300]–[304] TRS Denied Code Entry for Levels 2 through 6..... | 3-36 |
| | [305]–[309] TRS Excepted Code Entry for Levels 2 through 6..... | 3-36 |
| 3.7 | ISDN Port Programming..... | 3-37 |
| | [400] ISDN Port Connection Assignment | 3-37 |
| | [401]–[402] Intercept Extension — Day/Night | 3-37 |
| | [403] Host PBX Access Codes..... | 3-37 |
| | [404] CLIP/COLP Number Assignment | 3-38 |
| | [405] Direct Dialling In | 3-38 |
| | [406] ISDN Configuration | 3-39 |
| | [407] Multiple Subscriber Number Set | 3-39 |
| | [408]–[409] Extension Ringing Assignment — Day/Night for ISDN | 3-39 |
| | [410]–[411] ISDN Extension Ringing Assignment — Day/Night for ISDN | 3-40 |
| | [412] ISDN DDI Number/Extension Number Transformation..... | 3-40 |

Contents

| | |
|--|-------------|
| 3.8 COS Programming..... | 3-41 |
| [500]–[501] Toll Restriction Level — Day/Night..... | 3-41 |
| [503] Call Forwarding to Outside (CO) Line..... | 3-41 |
| [504] Do Not Disturb Override..... | 3-41 |
| [505] Account Code Entry Mode..... | 3-41 |
| [506]–[507] Toll Restriction Level for System Speed Dialling — Day/Night..... | 3-42 |
| [508] Door Opener Access..... | 3-42 |
| [509] Night Service Access..... | 3-42 |
| [510] Do Not Disturb for Direct Dialling In Call..... | 3-43 |
| [511] Call Forwarding — Follow Me..... | 3-43 |
| [512] Calling Line Identification Restriction (CLIR)..... | 3-43 |
| [513] Connected Line Identification Restriction (COLR)..... | 3-43 |
| [514] Executive Busy Override..... | 3-44 |
| [515] Executive Busy Override Deny..... | 3-44 |
| [517] Call Forwarding by ISDN Service..... | 3-44 |
| 3.9 Extension Programming..... | 3-45 |
| [600] EXtra Device Port..... | 3-45 |
| [601] Class of Service..... | 3-45 |
| [602] Extension Group Assignment..... | 3-45 |
| [603]–[604] DIL 1:N Extension and Delayed Ringing — Day/Night..... | 3-46 |
| [605]–[606] Outgoing Permitted ISDN Port Assignment — Day/Night..... | 3-46 |
| [607]–[608] Doorphone Ringing Assignment — Day/Night..... | 3-46 |
| [609] Extension Connection Assignment..... | 3-47 |
| [610] IRNA Assignment..... | 3-47 |
| [611] TAM Connection Assignment..... | 3-47 |
| [612] Data Line Security..... | 3-48 |
| [613] Department Codes..... | 3-48 |
| [614]–[615] Doorphone Call Forwarding – Day/Night..... | 3-48 |
| 3.10 ARS Programming..... | 3-49 |
| [700] ARS Mode..... | 3-49 |
| [701] ARS Carrier Code..... | 3-49 |
| [702] ARS Route Selection Code..... | 3-49 |
| [703] ARS Authorization Code..... | 3-50 |
| [704] ARS Itemized Bill Code..... | 3-50 |
| [705] 1st Carrier Access Code..... | 2-50 |
| [706] ARS Route Exceptional Code..... | 3-51 |
| [708] ARS Modify Removed Digit..... | 3-51 |
| [709] ARS Modify Added Number..... | 3-51 |

Contents

| | |
|---|-------------|
| 3.11 Resource Programming | 3-52 |
| [800] SMDR Incoming/Outgoing Call Log Printout..... | 3-52 |
| [801] SMDR Format..... | 3-52 |
| [802] System Data Printout | 3-52 |
| [803] Music Source Use | 3-53 |
| [804] Serial Interface (RS-232C) Parameters..... | 3-53 |
| 3.12 Optional Programming | 3-54 |
| [900] System Data All Clear | 3-54 |
| [901] System Data Clear Except ISDN Data | 3-54 |
| [902] System Additional Information..... | 3-55 |
| [903] Received Number Check | 3-58 |
| 3.13 PC Programming | 3-59 |
| 3.14 Programming Tables | 3-60 |

Section 4 Installation

| | |
|--|-------------|
| 4.1 Before Installation | 4-2 |
| 4.2 Unpacking | 4-4 |
| 4.3 Names and Locations | 4-4 |
| 4.4 Wall Mounting | 4-5 |
| 4.5 Opening the Front Cover | 4-5 |
| 4.6 Connecting the Frame Earth | 4-5 |
| 4.7 ISDN Line Connection Structure | 4-6 |
| 4.8 CO Line Connection | 4-7 |
| 4.9 Extension Connection | 4-8 |
| 4.10 Connecting the Telephones in Parallel | 4-10 |
| 4.11 Connecting the Telephones in EXtra Device Port (XDP) | 4-11 |
| 4.12 Installing the Optional Cards | 4-12 |
| 4.13 Expanding the ISDN Line Connection | 4-14 |
| 4.14 Connecting the Doorphone and Door Opener | 4-15 |
| 4.15 Connecting the Printer and PC | 4-17 |
| 4.16 Installing the Lightning Protector | 4-20 |
| 4.17 Closing the Front Cover | 4-22 |
| 4.18 Starting the System for the First Time | 4-22 |
| 4.19 Restarting the System | 4-23 |

Contents

| | | |
|------------------|--|-------------|
| Section 5 | Appendix | |
| 5.1 | Tones / Ring Tones | 5-2 |
| 5.2 | LED Indication | 5-5 |
| 5.3 | Feature Number List | 5-6 |
| 5.4 | Default Values | 5-9 |
| 5.5 | Specifications | 5-12 |
| | 4.5.1 General Description | 5-12 |
| | 4.5.2 Characteristics | 5-13 |
| | 4.5.3 System Capacity..... | 5-13 |
| 5.6 | Troubleshooting | 5-14 |
| | 4.6.1 Installation and Operation | 5-14 |
| | 4.6.2 Connection | 5-15 |
| 5.7 | Template | 5-16 |

Section 1
System Outline

1.1 Basic System Construction

The KX-TD208 has a basic capacity of eight extensions and one ISDN line. Two Outside (CO) lines can be supported on one ISDN port basis. It is capable of supporting single line devices such as single line telephones, facsimiles and data terminals.

To expand its capabilities, the system can be equipped with optional components such as Panasonic digital proprietary telephones, or customer-supplied peripherals such as a door opener.

System Connection Diagram

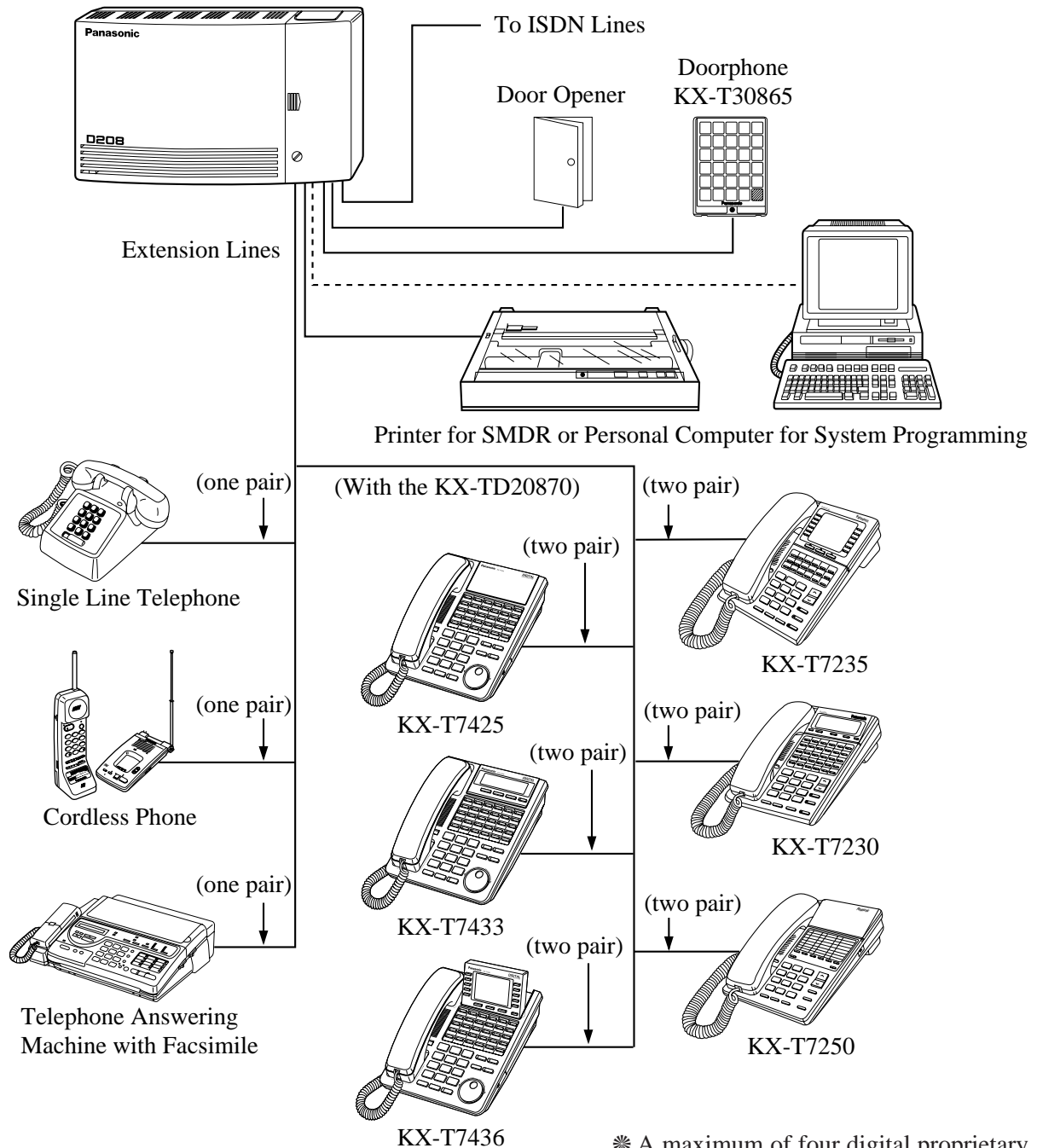

* A maximum of four digital proprietary telephones can be connected.

1.2 *System Highlights*

System Capacity

| | | |
|-------------------------|---|--|
| Basic System | Extension lines | 8 |
| | ISDN line | 1 (2 CO lines) |
| Expansion | ISDN line | 1 (either for 8 extension lines or 2 CO lines) |
| Maximum Capacity | When an optional ISDN line is used for CO lines: | |
| | Extension lines | 8 |
| | CO lines | 4 |
| | When an optional ISDN line is used for extension lines: | |
| | Extension lines | 8 |
| | ISDN extension lines | 8 |
| | CO lines | 2 |

Module Expansion

Expansion modules are used to increase the system capacity. The optional card, KX-TD20880, supports one ISDN line, whose port can be selected to be used for a CO line or extension line (Default: CO line).

Digital Proprietary Telephones (DPT)

By installing the optional card, KX-TD20870, the system can support up to four proprietary telephones and four more single line telephones (max.). In this case, an XDP connection is required. Refer to “EXtra Device Port (XDP)” on the next page. Six different models of digital proprietary telephones, ranging from a monitor set to a large handsfree display version, are available.

Account Management

Allows the user to manage the telephone charge by using certain features; such as Calling with Account Codes and Referring to the Charges. For details, refer to each feature.

Automatic Route Selection (ARS)

Automatically selects the pre-programmed least expensive route for outgoing toll calls.

Data Line Security

Communication between the extension and other end is protected from any signal such as Call Waiting, Hold Recall and Executive Busy Override.

Executive Busy Override

Allows the pre-assigned extension user to enter into an existing call to establish a three-party conference.

Uniform Call Distribution (UCD)

Allows an incoming call to be distributed uniformly to a specific group of extensions.

1.2 *System Highlights*

EXtra Device Port (XDP)*

Extension jacks 1 through 4 in the system support the connection of a digital proprietary telephone and a single line device. The devices have different extension numbers and are treated as two completely different extensions.

Paralleled Telephone Connection*

Extension jacks 1 through 4 in the system also support the parallel connection of a proprietary telephone and a single line device. They share the same extension number and are considered by the system to be one extension.

Selecting the CLIP/COLP numbers

You can inform your CLIP/COLP number (which is classified as either business use or private use) to the other party or to the ISDN Network.

Section 2
Operations

2.1 Before Operating

What kind of telephone do you use?

In this manual, you will find your way to operate the feature depending on the telephone you use. If you use single line devices such as a single line telephone or data terminal, you will follow the steps which enter the feature number. If you use single line devices which do not have the “*” or “#” key, it is impossible to access features that have “*” or “#” in their feature numbers. If you use a Panasonic proprietary telephone which has the special function button and/or the display, you will follow the operation with the button or display for easy access. If you use a Panasonic proprietary telephone which does not have the function button, you may change one of the unused buttons to another button. Refer to the Initial Settings (Section 2.2).

A Panasonic proprietary telephone has the Light Emitting Diode (LED) button indicators, so you can see the line conditions by the lighting patterns. Refer to LED Indication (Section 5.2). Please use the proper operation for your telephone.

Description of Symbols Used

In this manual, many symbols are used. Most symbols do not need a description, but some symbols do. They are as follows.



Lift the handset, or press the SP-PHONE or MONITOR button.
(Off-hook)



Replace the handset, or press the SP-PHONE or MONITOR button.
(On-hook)



RECALL button on a single line telephone.



Tones which vary depending on the condition.
(Refer to the Tones / Ring Tones in Section 5.)



Number keys on the telephone vary depending on the condition.



- For proprietary telephone operations, all button illustrations are based on the model KX-T7235.
- The button illustrations may be different if you use KX-T7400 series telephones. In this case, please check the button names.

2.1 Before Operating

What is your contract with the telephone company?

For basic PBX use, some programming is required.

You must check your contract with the telephone company first. Then follow the chart below.

For a description of each programming, please refer to Section 3.

Before programming

A proprietary telephone or tone type Single Line Telephone (SLT) is required for system programming.

Connect the telephone to either of the following:

- Jack number 1 (Extension number 21)
- Jack number 2 (Extension number 22)

Programming type selection

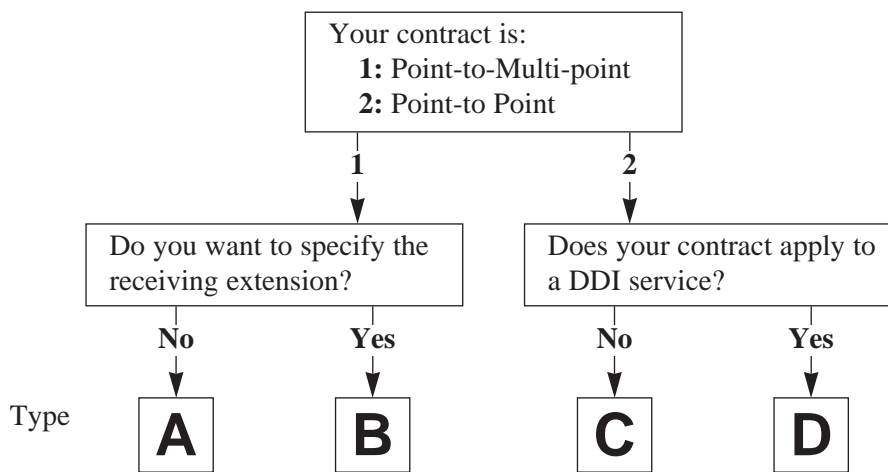

Programming

Step 1. Enter into the programming mode.

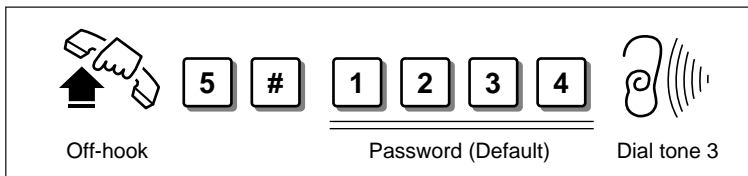

Step 2. Program [404] to all the types A, B, C, D.

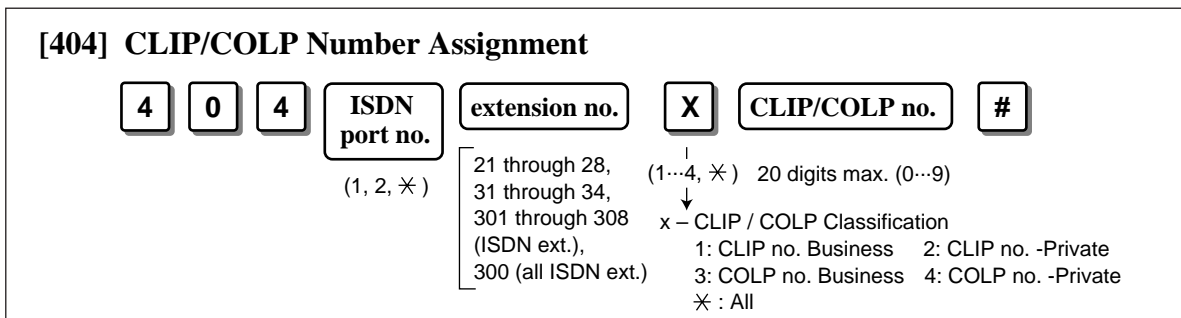

(Continued)

2.1 Before Operating

Step 3. Follow the chart according to your programming type.

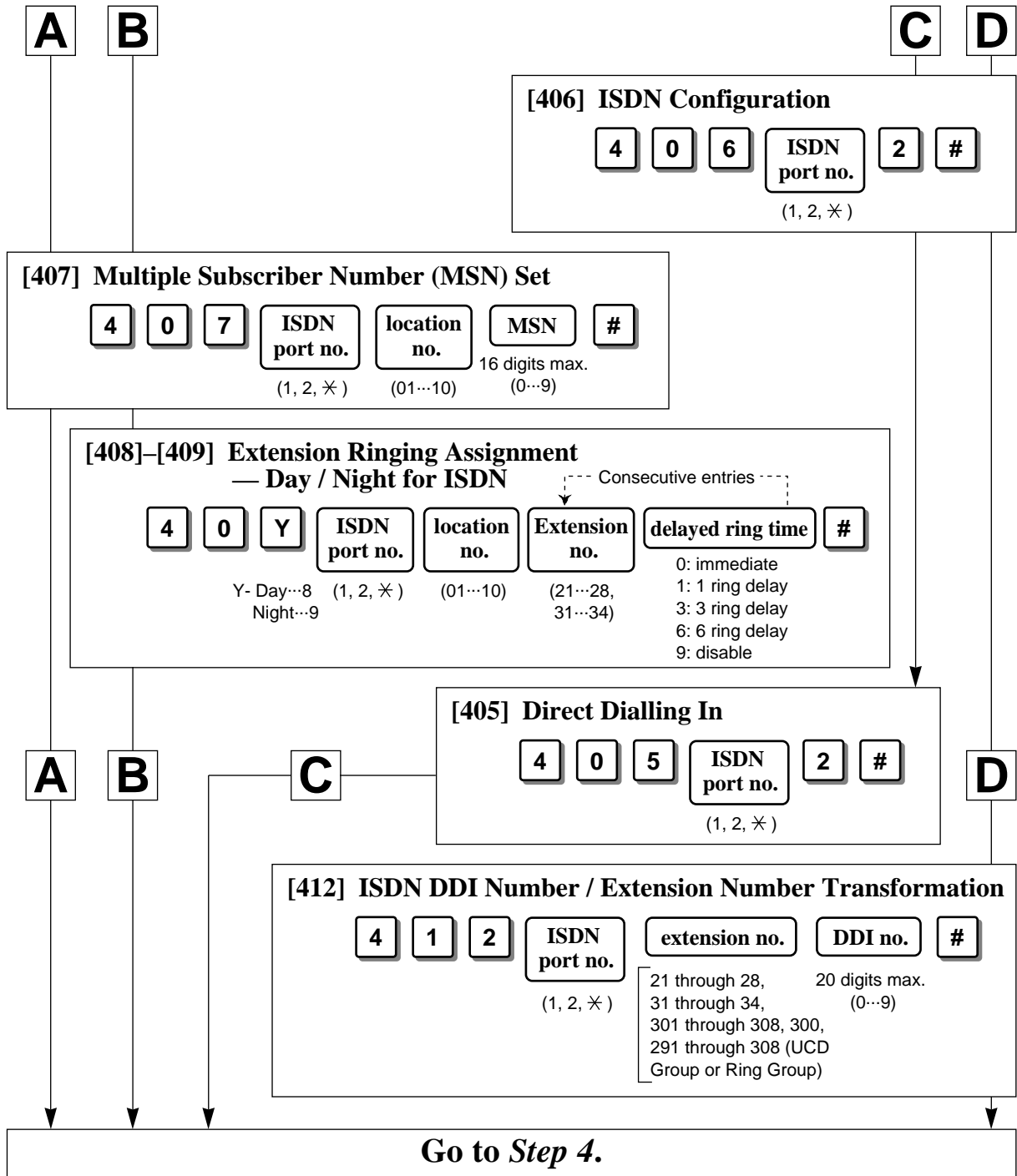

Step 4. Exit from the programming mode.

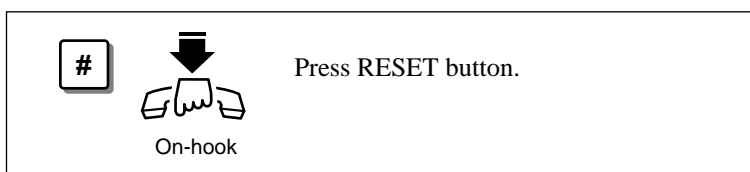

2.1 Before Operating

Operating example

Example: “When the dialled line is busy — Sending a Call Waiting Tone to a Busy Extension (Busy Station Signalling)”

Main feature title

When the Dialled Line is Busy

Sub-feature title

Sending a Call Waiting Tone to a Busy Extension (Busy Station Signalling)

Allows you to inform a busy extension that you are waiting by sending a Call Waiting tone.

Feature description

Applicable telephone:
SLT and PT users can follow the operating steps below.

CALL WAITING TONE

Applicable telephone:
KX-T7230/KX-T7235/
KX-T7433/KX-T7436
users can execute not only the button operation but also the display operation below.

SLT and PT

If you make an intercom call and hear a busy tone;

2

Dial 2. Wait for an answer and talk.

7230/7235/7433/7436

If you make an intercom call and hear a busy tone;

BSS

S1

S2

S3

Press BSS (S1). Wait for an answer and talk.

Operating steps

! • To answer the BSS call, refer to “Call Waiting” in this manual.
• This feature is effective when the called extension has enabled Call Waiting. If Call Waiting is disabled, the caller will hear a reorder tone.

• During a Conversation (Section 2.5) Call Waiting

The feature and program reference

Additional information

- !** • If your telephone is not noted in the operating step box (ex. only “PT” is noted), this means your telephone does not have the ability to execute that feature.
- If your telephone has the ability to perform several operations for one feature, you can select the method according to your needs.
- If “Any telephone” is applicable with an operation, you can use SLTs, ISDN-Telephones and PTs for the operation.

2.2 Initial Settings

If you use a Panasonic proprietary telephone (see page 2), you can customise your telephone functions. For example, you can change the button functions on the telephone or the initial settings for your convenience.



- If you move your desk and change the extension line, reset as desired. The setting will not remain on your telephone but will remain in the previous extension user's memory.
- If your telephone has no **PROGRAM** button, use the **PAUSE** button instead.
- During the programming mode, your extension is treated as a busy extension.
- If no entry is entered within one minute, the programming mode is cancelled and the mode returns to the normal status.
- You can quit programming anytime by lifting up the handset.

Customising Your Telephone Functions

Changing the Initial Settings

You can change the initial settings of your telephone. Check the available items in the list and change the settings, if required.

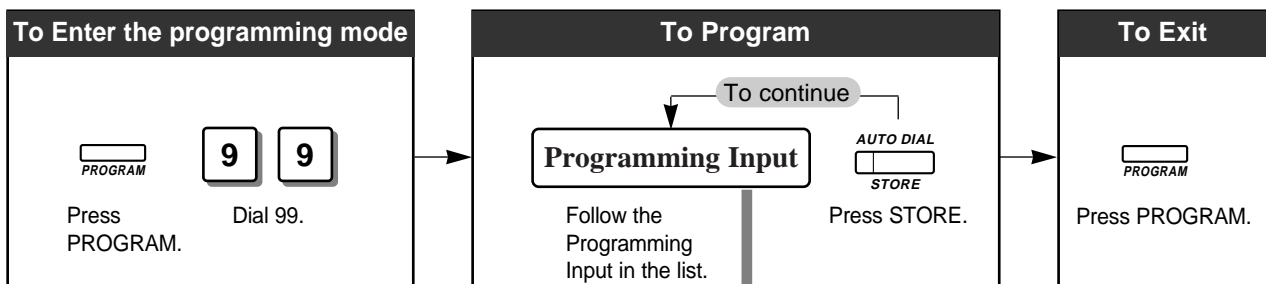

| ITEM | SELECTION | PROGRAMMING INPUT |
|---|--|------------------------------|
| Which line do you prefer to seize when you go off-hook to make calls? (Preferred Line Assignment – Outgoing) | <input type="checkbox"/> No line selected. | 1 1 |
| | <input type="checkbox"/> An idle outside line (CO) | 1 2 |
| | <input type="checkbox"/> A pre-assigned ISDN port | 1 3 ISDN port no. (1...2) |
| | <input type="checkbox"/> The intercom line (Default) | 1 INTERCOM |

2.2 Initial Settings

| ITEM | SELECTION | PROGRAMMING INPUT |
|---|--|---|
| Which line do you prefer to seize when you go off-hook to receive calls? (Preferred Line Assignment – Incoming) | <input type="checkbox"/> No line selected. | 2 1 |
| | <input type="checkbox"/> The ringing outside line (CO) (Default) | 2 2 |
| | <input type="checkbox"/> A pre-assigned ISDN port | 2 3 ISDN port no. (1...2) |
| Which way do you prefer to dial the One-Touch Dialling feature? (Full One-Touch dialling Assignment) | <input type="checkbox"/> Go Off-hook and then press the One-Touch Dialling button. | 3 1 |
| | <input type="checkbox"/> Just press the One-Touch Dialling button. (Default) | 3 2 |
| Which way do you prefer to receive an intercom call? (Intercom Alert Assignment) | <input type="checkbox"/> Ringing (Default) | 4 1 |
| | <input type="checkbox"/> The party's voice is heard right after the confirmation tone. | 4 2 |
| Do you prefer to distinguish the Call Waiting Tone received from an outside line (CO) and intercom? (Call Waiting Tone Type Selection) | <input type="checkbox"/> No. Use the same tone (tone 1). (Default) | 5 1 |
| | <input type="checkbox"/> Yes. Use a different tone (tone 2). | 5 2 |
| Do you prefer a tone when pressing the dialling buttons? (Key Click Tone Assignment) | <input type="checkbox"/> No. Turn off the tone. | 7 1 |
| | <input type="checkbox"/> Yes. (Default) | 7 2 |
| Which receiving equipment will you use? (Handset/Headset Selection — DPT only) | <input type="checkbox"/> Handset (Default) | 8 1 |
| | <input type="checkbox"/> Headset | 8 2 |



• **To confirm the stored function data;**

The stored function data will be displayed by pressing the first digit of the Programming Input while in programming mode. If the function is not required to be changed, press the **HOLD** button to return to the initial programming display.

(Continued)

2.2 *Initial Settings*

Clearing the Programmed Data

Allows you to clear all of the data in the list, so that each item returns to its initial setting.

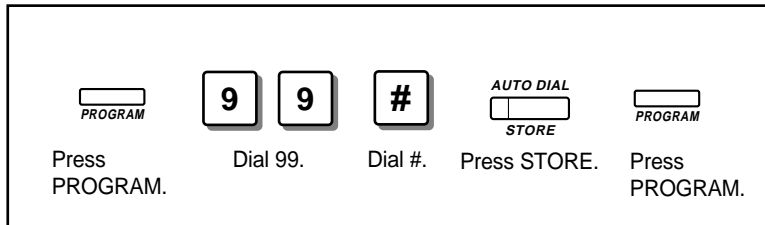

2.2 Initial Settings

Customising the Buttons on Your Telephone

Changing the Flexible Buttons

You can change the flexible buttons on your telephone to certain function buttons. For example, your telephone has more outside line (CO) buttons than available CO lines, so you may change unused CO buttons to one-touch dialling buttons, etc.

Programmable buttons are:

- Flexible CO button

- Flexible DSS button

- Programmable Function (PF) button

Check the required operation first, and if your telephone is not provided with the convenient button, you can assign the button here.

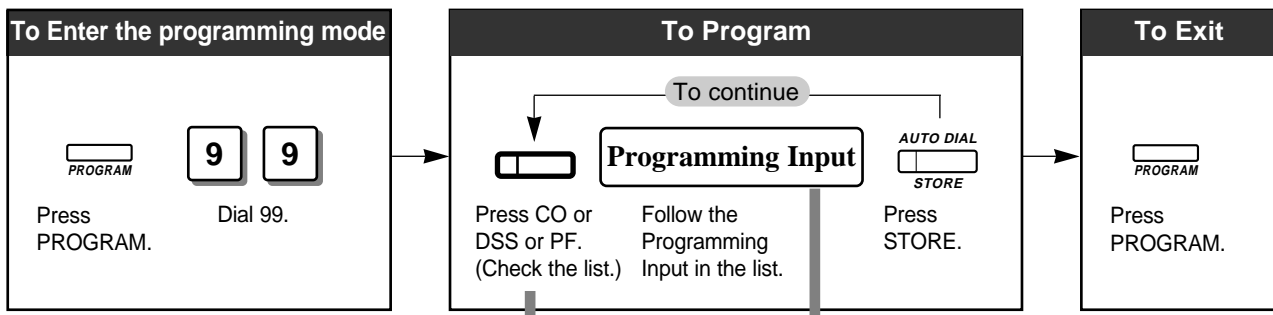

| FUNCTION | PROGRAMMABLE BUTTON | | | PROGRAMMING INPUT |
|-------------------------------------|---------------------|-----|----|-----------------------------------|
| | CO | DSS | PF | |
| Direct Station Selection (DSS) | ✓ | ✓ | | 1 extension no. |
| One-Touch Dialling | ✓ | ✓ | ✓ | 2 desired no. (16 digits max.) |
| MESSAGE | ✓ | ✓ | | 3 |
| FWD/DND (Forward/Do Not Disturb) | ✓ | ✓ | ✓ | 4 |
| SAVE | ✓ | ✓ | ✓ | 5 |

(Continued)

2.2 Initial Settings

| FUNCTION | PROGRAMMABLE BUTTON | | | PROGRAMMING INPUT |
|--------------------------|---------------------|-----|----|--|
| | CO | DSS | PF | |
| Account | ✓ | ✓ | ✓ | [6] |
| CONFERENCE | ✓ | ✓ | ✓ | [7] |
| Log-In/Log-Out | ✓ | | | [8] [0] |
| Terminate | ✓ | ✓ | ✓ | [9] |
| Single-outside line (CO) | ✓ | | | [0] [outside line no. (1...4)] |
| Loop-outside line (CO) | ✓ | | | [*] |
| ISDN Service | ✓ | ✓ | ✓ | [8] [9] [ISDN service no. (0...9, *, #, 16 digits max.)] |



- **When storing a One-Touch Dialling button;**
 - To store the telephone number of an outside party, the port access code (9, 81 or 82) must be stored as the leading digit.
 - You can use 0 through 9, *, #, PAUSE, RECALL, CONFERENCE, and INTERCOM as follows:
 - RECALL: registers the recall signal
 - PAUSE or * *: pause
 - CONFERENCE: - (hyphen) after the line access code
 - INTERCOM: [or] (secret code) — Press the INTERCOM button before and after the part you wish to conceal when it is shown on the display when dialling.
- **To confirm the stored function data;**

The stored data will be displayed by pressing the desired button while in the programming mode. If the data is not required to be changed, press the **HOLD** button to return to the initial programming display.
- ISDN service number depends on the services which you want to perform. For more information about the ISDN services or the specific numbers, please consult with your ISDN network suppliers.
- The availability of the ISDN services depends on your ISDN contract.

2.2 Initial Settings

Clearing the Data on the Flexible Button

Allows you to clear the stored function.

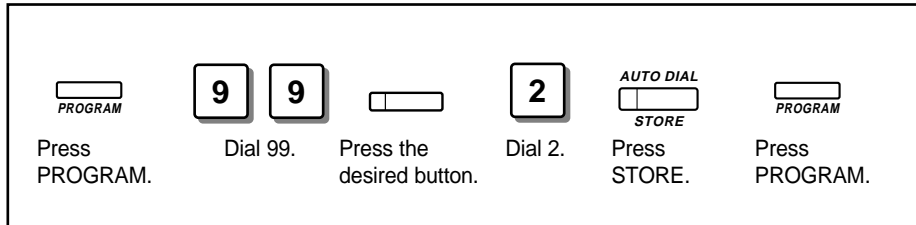

Distinguishing the ringing tone for each CO button

You can change the ringing tone for each flexible CO button. There are eight ringing tone types. (Default: Tone type 2) Refer to the “Tones / Ring Tones” (Section 5).

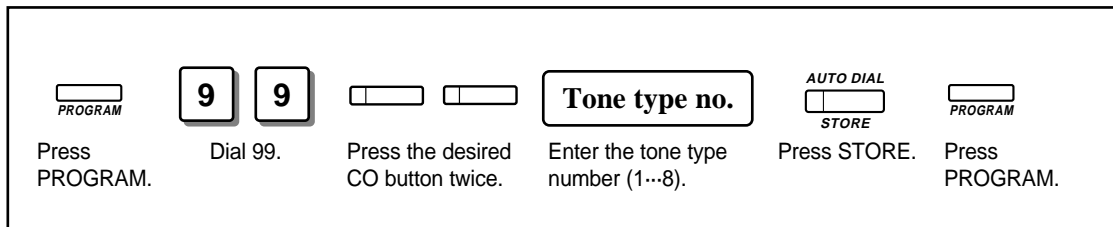

2.3 *Making Calls*

Intercom Calling

Allows you to make a call to another extension within the system.

All extensions have a fixed extension number as follows:

Standard Connection

SLT/PT extension number: 21 through 28 (25 through 28 are available only for a SLT)

ISDN extension number: 301 through 308 (300 for all ISDN extensions)

XDP* Connection

DPT extension number: 21 through 24

SLT extension number: 31 through 34

*A XDP (EXtra Device Port) expands the number of telephones available in the system by allowing an extension port to contain two telephones. Refer to System Management.



- You can alternate the calling mode, ring or voice, by pressing “*”, or the “Tone (S2)” or “Voice (S3)” button under the display (KX-T7230/T7235/T7433/T7436) after dialling. You can also select the way to receive intercom calls (Intercom Alert Assignment). Refer to “Customising Your Telephone Functions” in Initial Settings (Section 2.2).
- If your telephone has a display, you can enter and confirm the required numbers before going off-hook. You can erase a number by pressing “*.”
- If you want to dial and talk to the other party without lifting the handset, press the SP-PHONE button. To switch from the handsfree to handset mode, lift the handset.
- Proprietary telephone users can make an intercom call simply by pressing the DSS (Direct Station Selection) button, if assigned.
- With the KX-T7235, KX-T7433 and KX-T7436, you can make an intercom call with the display operation.
- An INTERCOM button provides the line status condition by the lighting pattern and colour indication. Refer to the “LED Indication” (Section 5).
- You may hear a special tone after dialling. In this case, refer to the “Tones / Ring Tones” (Section 5).



- Initial Settings (Section 2.2)
 - Customising the Buttons on Your Telephone
- Display Operation (Section 2.7)
 - Display Operation – Extension
- System Management (Section 3.1)
 - EXtra Device Port (XDP)

2.3 Making Calls

Making an Intercom Call

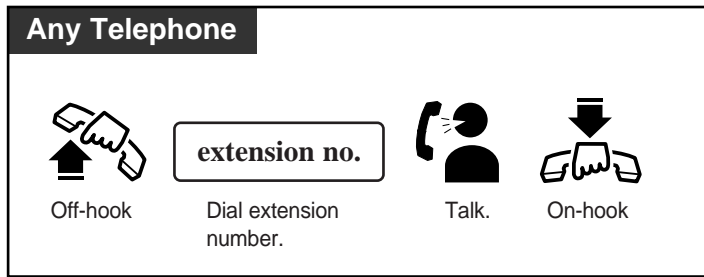

Calling a Manager (Manager Call)

Allows you to call a manager within the system.

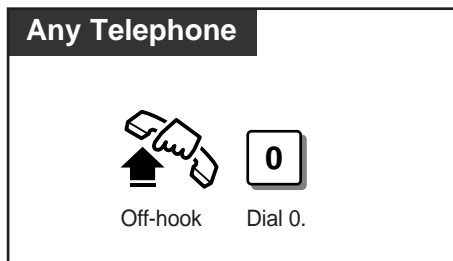

- ! • Extension 21 is the manager extension. You can also dial "21" to call the manager.

Calling an Extension Group (Ring Group)

All extensions in a ring group ring simultaneously by dialling the extension group number.

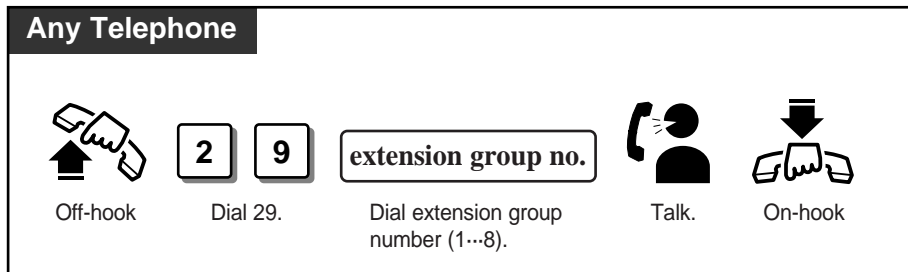

- ! • Types of calls whose destination can be the ring group are:
 - Outside calls – DDI; IRNA
 - Intercom calls – Extension; Transfer
- This feature requires a ring group assignment for a Station Hunting type in System Programming.



- System Programming (Section 3.4)
 - [102] Station Hunting Type
- Extension Programming (Section 3.9)
 - [602] Extension Group Assignment

2.3 Making Calls

Outside Calling

Allows you to make a call to an outside party.



- If you hear a reorder tone after seizing the outside line (CO), the call is denied by one of the following:
 - The ISDN port you have attempted to access is not assigned.
 - The extension has been locked by the extension user (Electronic Station Lockout) or the manager (Remote Station Lock Control).
 - The extension may be restricted by the account code mode (Account Code Entry). In this case, it is required to enter an account code.
 - The extension may be restricted from making toll calls (Toll Restriction).
- If your telephone has a display, you can enter and confirm the required numbers before going off-hook. You can erase a number by pressing “*.”
- If you want to dial and talk to the other party without lifting the handset, press the SP-PHONE button. To switch from the handsfree to handset mode, lift the handset.
- A flexible CO button can be assigned as a Single-CO or Loop-CO button. A specific outside line (CO) can be assigned to a Single-CO button, while all CO lines can be assigned to a Loop-CO button. Pressing a Single-CO button works as individual line access, while pressing a Loop-CO button works as automatic line access. Default is as follows:
 - CO 1,2 = Single-CO (ISDN port 1), CO 3,4 = Single-CO (ISDN port 2).
- CO buttons provide the line status condition by the lighting pattern and colour indication. Refer to the “LED Indication” (Section 5).
- You may hear a special tone after dialling. In this case, refer to the “Tones / Ring Tones” (Section 5).



- Initial Settings (Section 2.2)
 - Customising the Buttons on Your Telephone
- ISDN Port Programming (Section 3.7)
 - [400] ISDN Port Connection Assignment
- Extension Programming (Section 3.9)
 - [605]–[606] Outgoing Permitted ISDN Port Assignment — Day/Night

Making Outside Calls by Automatic Line Access



2.3 Making Calls

Making Outside Calls by Individual Line Access

Allows you to access a pre-assigned outside line.

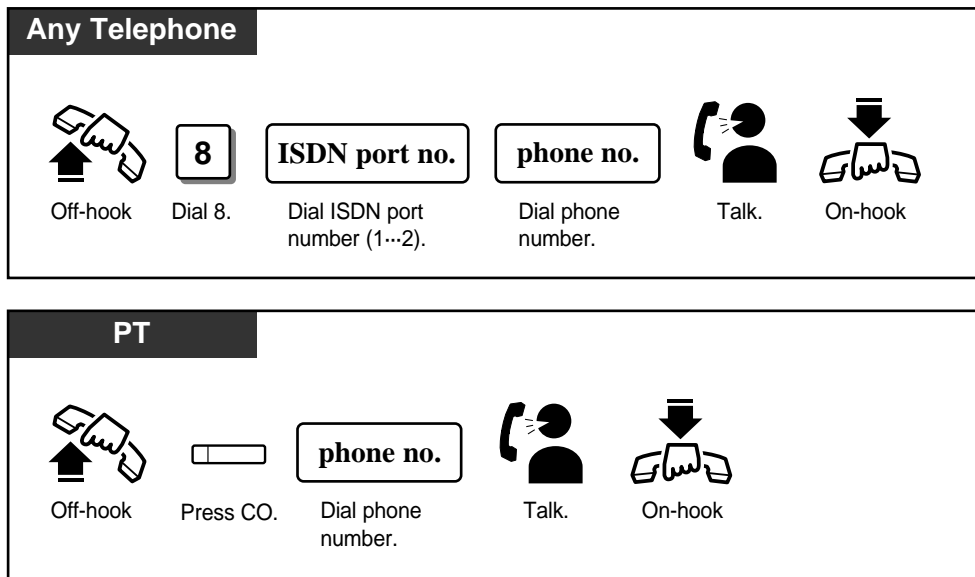

Making Emergency Calls (Emergency Call)

Allows you to make an emergency call. You can store up to four emergency numbers.

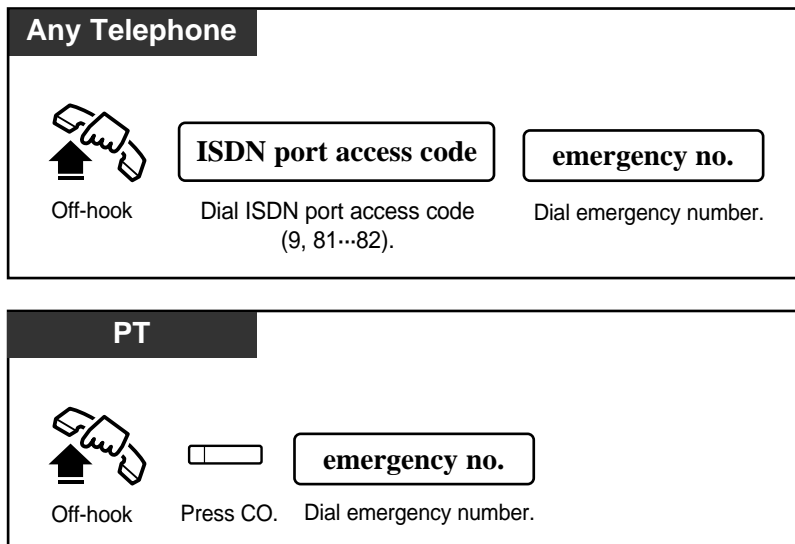

- Emergency numbers can be called even in the following cases;
 - in Account Code – Verified mode
 - in any toll restriction level
 - in Electronic Station Lockout



- Manager Programming (Section 3.3)
[002] Emergency Dial Number Set

2.3 Making Calls

Quick Dialling

Dialling Simply by Pressing a Button (One-Touch Dialling)

Allows you to call a number or access a system feature with the touch of a button. This is done by storing an extension number, a telephone number or a feature number in a One-Touch Dialling button.

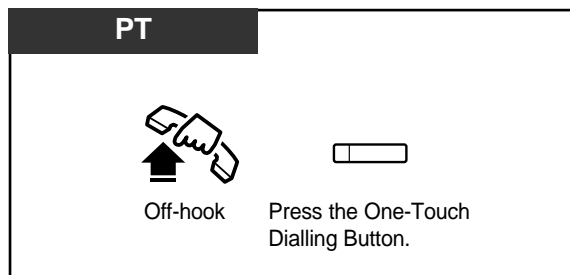

- To store numbers, refer to the Initial Settings.
- It is possible to store a number consisting of 17 digits or more by dividing it and storing it in two One-Touch Dialling buttons.
- You can also just press a One-Touch Dialling button (Full One-Touch Dialling). To change the assignment, refer to the Initial Settings.
- If there is a PAUSE in the assigned numbers, the numbers after the PAUSE are sent as DTMF signals.



- Initial Settings (Section 2.2)
 - Customising Your Telephone Functions
 - Customising the Buttons on Your Telephone

2.3 Making Calls

Dialling with a System Speed Dialling Button (System Speed Dialling)

Allows you to make outside calls using speed dial numbers previously programmed.
The system supports 100 speed dial numbers which are available to all extension users.

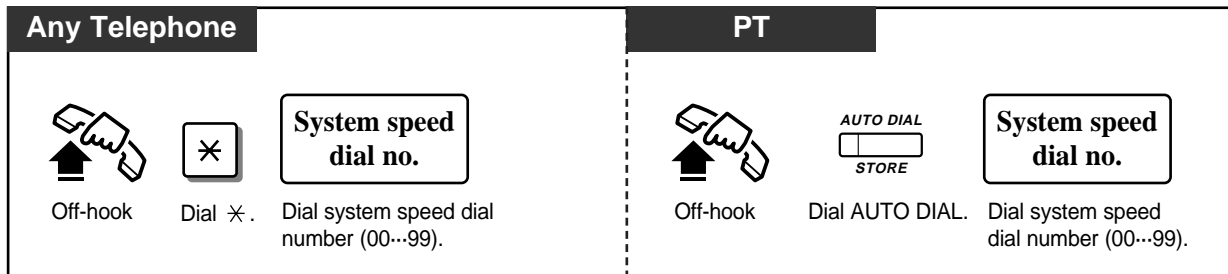

- System Speed Dial numbers must be stored by System Programming.
- Calls originated by System Speed Dialling are restricted depending on the extension's toll restriction level for System Speed Dialling (Toll Restriction Override for System Speed Dialling).
- With the KX-T7235, KX-T7433 and KX-T7436, you can execute this feature with the display operation.



- Display Operation (Section 2.7)
 - Display Operation – SYS Speed
- System Management (Section 3.1)
 - Toll Restriction Override for System Speed Dialling
- Manager Programming (Section 3.3)
 - [001] System Speed Dialling Number Set

2.3 Making Calls

Dialling with a Station Speed Dialling Button (Station Speed Dialling)

Allows you to store up to ten speed dial numbers which are only available to you.

Storing the phone number

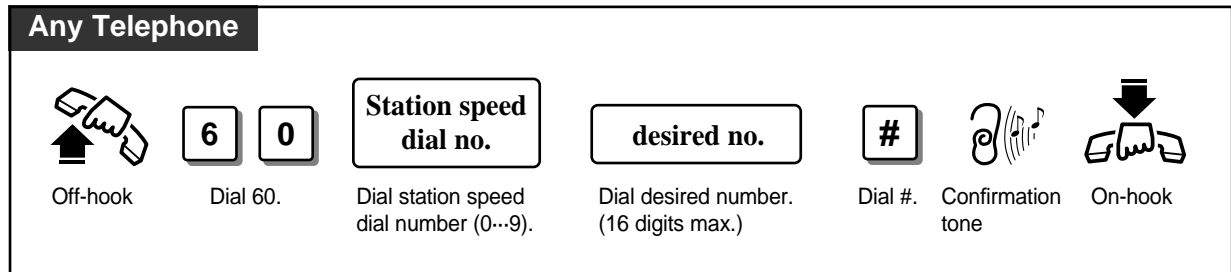

Dialling

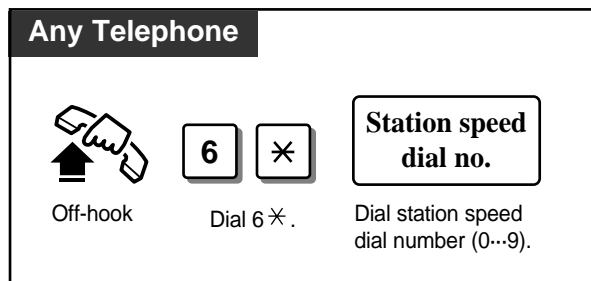

SSD Table

| SSD No. | NUMBER |
|---------|--------|
| 0 | |
| 1 | |
| 2 | |
| 3 | |
| 4 | |
| 5 | |
| 6 | |
| 7 | |
| 8 | |
| 9 | |

*You can write down and use the SSD Table for your reference.



- Up to 16 digits, consisting of “0 through 9” and “*”, can be stored.
- Enter “* *” for a PAUSE.
- If there is a PAUSE in the assigned numbers, the numbers after the PAUSE are sent as DTMF signals.
- You can store an extension number, a telephone number, or a feature number.
- To store the telephone number of an outside party, the ISDN port access code (9, 81 or 82) must be stored as the leading digit.
- With the KX-T7235, KX-T7433 and KX-T7436, you can execute this feature with the display operation.



- Display Operation (Section 2.7)
 Display Operation – STA Speed
 Station Speed Dialling Number/Name Assignment

2.3 Making Calls

Dialling Simply by Going Off-Hook (Pickup Dialling)

Allows you to make an outgoing call simply by going off-hook, if you have previously stored the telephone number.

Storing the phone number

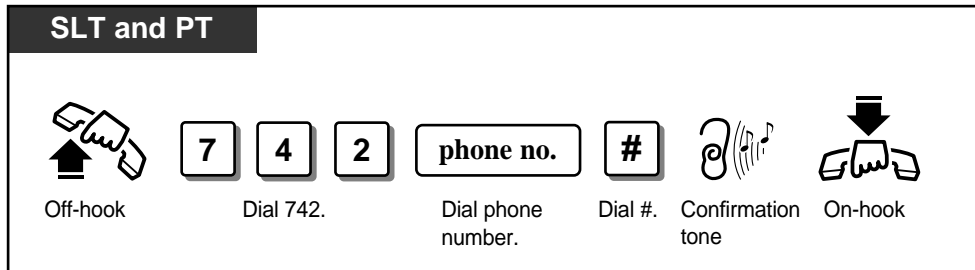

Setting / Cancelling

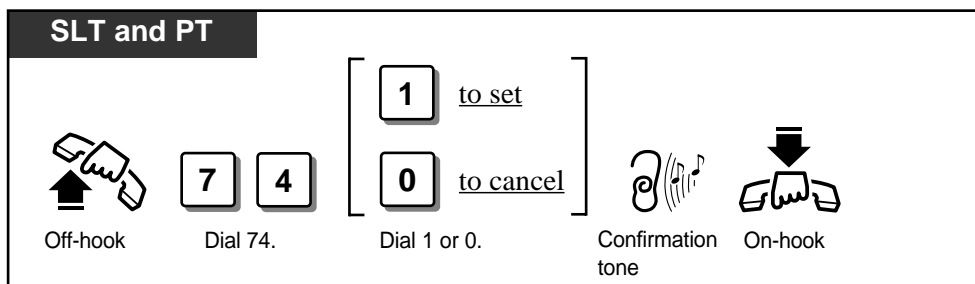

Dialling

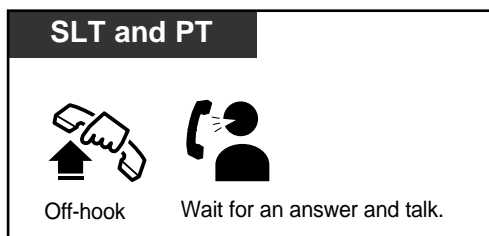

- ! A rotary dial telephone without the “#” button cannot program this feature. To program the phone number, temporarily replace the rotary dial telephone with a telephone which has the “#” button.
- To store the telephone number of an outside party, the ISDN port access code (9, 81 or 82) must be stored as the leading digit.
- Up to 16 digits, consisting of “0 through 9” and “*”, can be stored.
- Enter “* *” for a PAUSE.
- If there is a PAUSE in the assigned numbers, the numbers after the PAUSE are sent as DTMF signals.
- While waiting after lifting the handset, you can dial another party, which overrides this feature. The waiting time is programmable.



- Timer Programming (Section 3.5)
[204] Pickup Dial Waiting Time

2.3 Making Calls

Dialling the Stored Number with a SAVE Button (Notebook Function)

During a conversation with an outside party or in on-hook status, you can store an outside phone number without entering the ISDN port access number (9, 81 or 82) in memory. The stored number is dialled automatically through a CO line as follows:

If you store the phone number during a conversation – the same outside line (CO)

If you store the phone number while in on-hook status – the idle outside line (CO)

It is required to assign the SAVE button on your telephone beforehand.

Storing the number

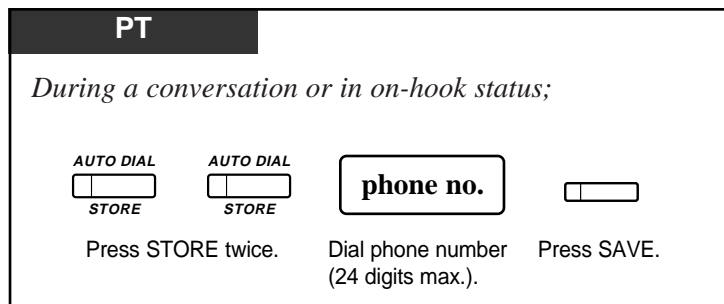

Dialling

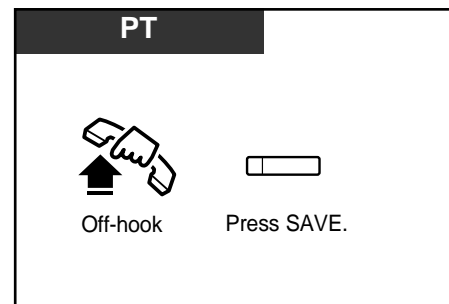

- You can select the desired outside line when dialling by pressing the desired CO button or dialling the ISDN port access number before pressing the SAVE button.
- If you dial in the handsfree mode (press SP-PHONE + SAVE button), redial will be repeated four times at 120 second intervals by default (Automatic Redial – DPT only). Repeating time and interval can be changed by System Programming.
- If there is a PAUSE in the assigned numbers, the numbers after the PAUSE are sent as DTMF signals.



- Initial Settings (Section 2.2)
 - Customising the Buttons on Your Telephone
- Timer Programming (Section 3.5)
 - [208] Automatic Redial Repeat Time
 - [209] Automatic Redial Interval Time

2.3 Making Calls

Redialling

Redialling the Last Dialed Number (Last Number Redial)

Automatically saves the last outside number you dialed and allows you to make the same outgoing call again.

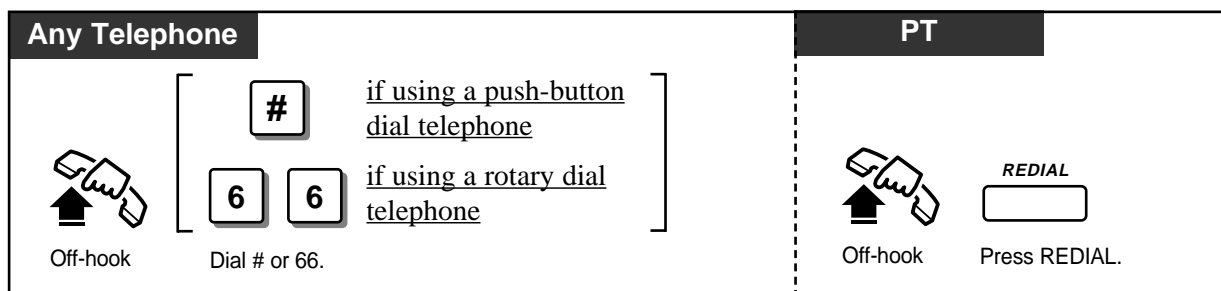

- A push-button dial telephone user can also use “66” for redialling, while a rotary dial telephone user can only use “66.”
- Up to 24 digits can be stored and redialled not including the ISDN port access code.
- The memorised telephone number is replaced by the next telephone number sent to a outside line (CO). Dialling only an ISDN port access code does not change the memorised number.
- If you dial in the handsfree mode (press SP-PHONE + REDIAL button), redial will be repeated four times at 120 second intervals by default (Automatic Redial – DPT only). Repeating time and interval can be changed by System Programming.
- If there is a PAUSE in the assigned numbers, the numbers after the PAUSE are sent as DTMF signals.



- Timer Programming (Section 3.5)
 - [208] Automatic Redial Repeat Time
 - [209] Automatic Redial Interval Time

2.3 Making Calls

Redialling the Saved Number (Saved Number Redial)

During a conversation or while hearing a busy tone, you can store a dialled telephone number to automatically redial the number through the same outside line later. The saved number can be redialled until another one is stored.

It is required to assign the SAVE button on your telephone beforehand.

Storing the number

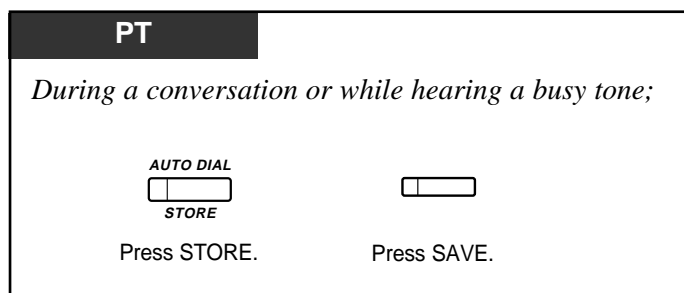

Dialling

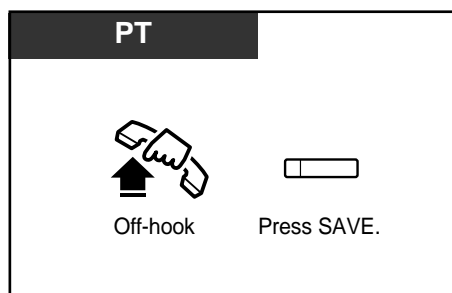

- Up to 24 digits can be stored and redialled not including the ISDN port access code.
- You can change the outside line when dialling. In this case, press the desired CO button or enter the ISDN port access number before pressing the SAVE button.
- If you dial in the handsfree mode (press SP-PHONE + SAVE button), redial will be repeated four times at 120 second intervals by default (Automatic Redial – DPT only). Repeating time and interval can be changed by System Programming.
- If there is a PAUSE in the assigned numbers, the numbers after the PAUSE are sent as DTMF signals.



- Initial Settings (Section 2.2)
 - Customising the Buttons on Your Telephone
- Timer Programming (Section 3.5)
 - [208] Automatic Redial Repeat Time
 - [209] Automatic Redial Interval Time

2.3 Making Calls

When the Dialed Line is Busy

Sending a Call Waiting Tone to a Busy Extension (Busy Station Signalling)

Allows you to inform a busy extension that you are waiting by sending a Call Waiting tone.

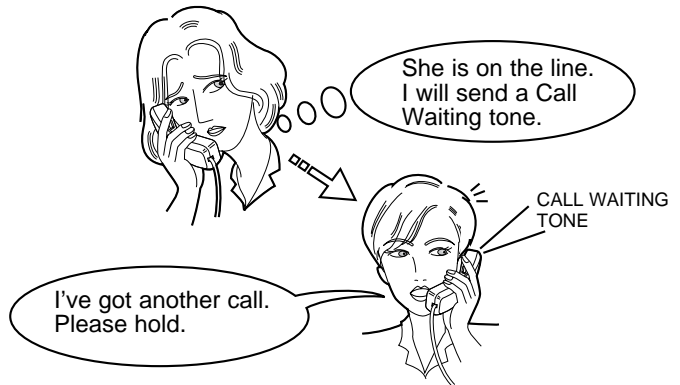

SLT and PT

If you make an intercom call and hear a busy tone;



Dial 2. Wait for an answer and talk.

7230/7235/7433/7436

If you make an intercom call and hear a busy tone;

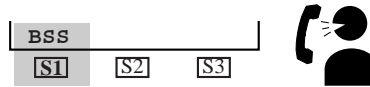

Press BSS (S1).

Wait for an answer and talk.



- To answer the BSS call, refer to “Call Waiting” in this manual.
- This feature is effective when the called extension has enabled Call Waiting. If Call Waiting is disabled, the caller will hear a reorder tone.



- During a Conversation (Section 2.5)
Call Waiting

2.3 Making Calls

Making Your Telephone Ring Back Automatically When a Line Becomes Free (Automatic Callback Busy – Camp On)

Allows you to be informed by callback ringing (Camp-On recall) when the called party or the selected outside line (CO) becomes free.

Automatic Callback – Extension

If you answer the callback ringing, the called extension automatically starts ringing.

Automatic Callback – outside line (CO)

If you answer the callback ringing, the line is automatically selected to let you make an outside call.

Setting

SLT and PT

If you hear a busy tone;



Dial 6.



Confirmation tone



Reorder tone



On-hook

Wait for
the Camp-On recall.

7230/7235/7433/7436

If you hear a busy tone;

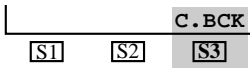

Press C.BCK (S3).



Confirmation tone



Reorder tone



On-hook

Wait for
the Camp-On recall.

Cancelling

SLT and PT



Off-hook



Dial 46.



Confirmation tone



On-hook

Answering an intercom recall

SLT and PT

If you hear the Camp-On recall;



Off-hook

The called extension
starts ringing.

Answering an outside line (CO) recall

SLT and PT

If you hear the Camp-On recall;



Off-hook

phone no.

Dial phone number.



- If the Camp-On recall is not answered in four rings (within 10 seconds), this feature will be automatically cancelled.

2.3 Making Calls



Interrupting an Existing Call (Executive Busy Override)

Allows the pre-assigned extension user to interrupt an existing call to establish a three-party conference call. You can also deny to be interrupted your conversation from other extension users.

Interrupting an existing extension call

SLT and PT



If you make an intercom call and hear a busy tone;

  A three-party conference is now established.

Dial 3. Confirmation tone

Interrupting an existing outside call

PT

Off-hook Press CO corresponds to the call that you want to interrupt. Confirmation tone

To leave the conference





SLT and PT

 The other two parties continue their conversation.

On-hook

Denying an existing call to be interrupted (Executive Busy Override Deny)

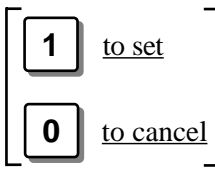
SLT and PT

Off-hook Dial 733. Dial 0 or 1. Confirmation tone On-hook



- When interrupting an existing extension call, you must dial within 10 seconds while a busy tone is heard.
- Class of Service programming determines which extension users can perform this feature.
- This feature does not work if the extension has set Denying an existing call to be interrupted or Data Line Security.



- COS Programming (Section 3.8)
 - [514] Executive Busy Override
 - [515] Executive Busy Override Deny

2.4 Receiving Calls

Receiving Calls

Receiving calls

Allows you to receive a call.

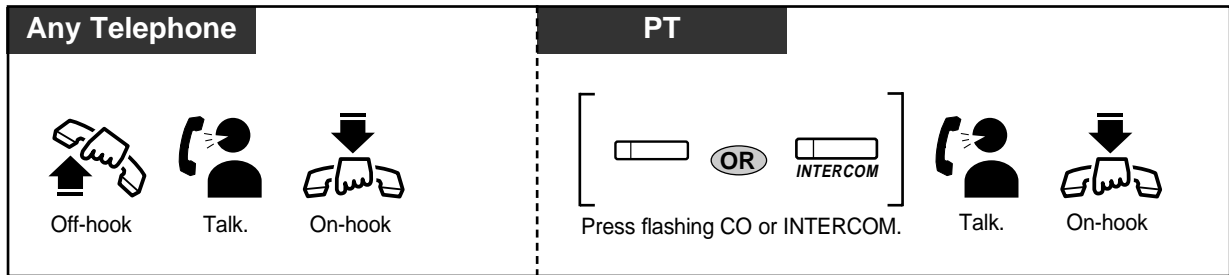

- If you want to answer an intercom call without going off-hook, press the AUTO ANSWER button (**Handsfree Answerback**). To cancel the Handsfree Answerback, press the AUTO ANSWER button again.

2.4 Receiving Calls

Picking up a Call

Picking up a Call Ringing at Another Extension (Call Pickup)

Allows you to answer an incoming call that is ringing at another telephone. The following types are available:

Outside line (CO) Call Pickup: Picks up an outside call.

Directed Call Pickup: Picks up the desired outside, intercom or doorphone call.

Group Call Pickup: Picks up an outside, intercom or doorphone call within your extension group.

You can also deny pick up calls from another extension.

Outside line (CO) Call Pickup

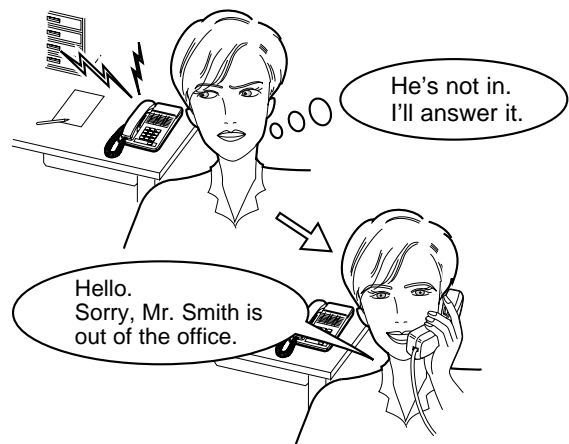
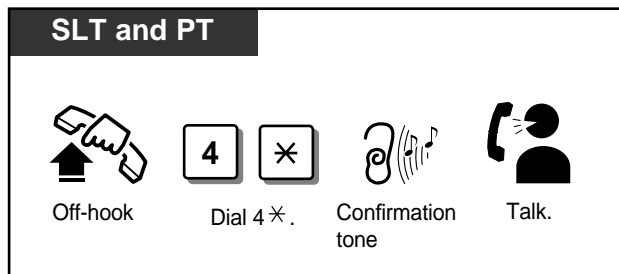

Directed Call Pickup

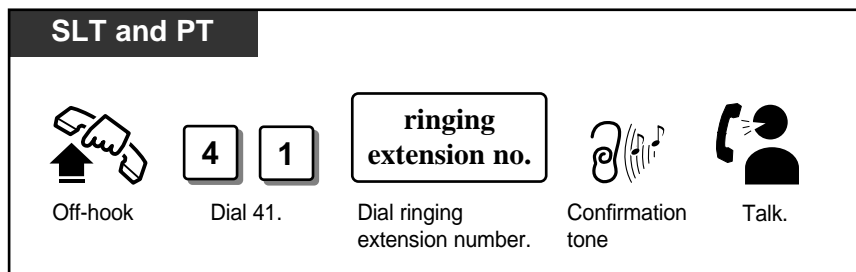

Group Call Pickup

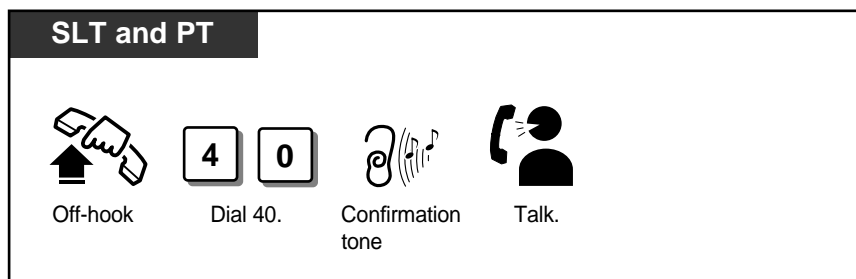

2.4 Receiving Calls

Denying / allowing your call to be picked up (Call Pickup Deny)

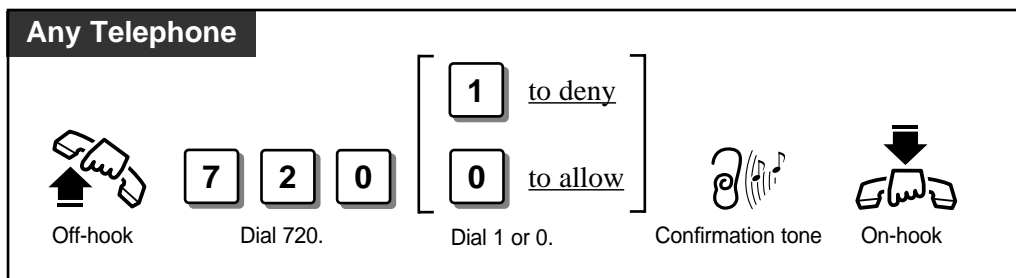

- A doorphone call can be picked up from any extension if it is not programmed to answer doorphone calls.
- If you set to deny the Call Pickup, Dial Tone 2 will be heard when you go off-hook.
- With the KX-T7235, KX-T7433 and KX-T7436, you can execute Group Call Pickup with the display operation.



- Display Operation (Section 2.7)
System Feature List
- Extension Programming (Section 3.9)
[602] Extension Group Assignment
- Optional Programming (Section 3.12)
[902] System Additional Information

Picking Up a Call from Telephone Answering Machine (TAM) (Call Pickup from TAM)

Allows you to pick up an incoming call received by TAM.

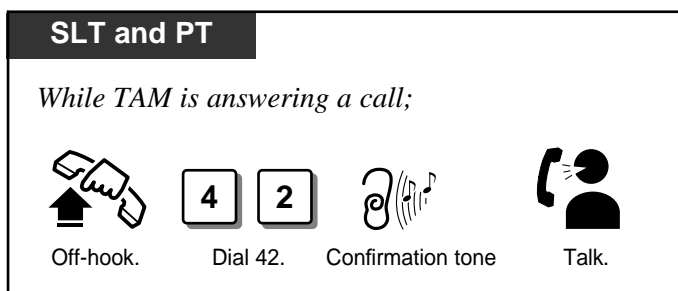

- An incoming intercom call, outside call and doorphone call can be picked up.
- When you try to pick up a call and hear a reorder tone, the call between the TAM and caller has finished.
- If a TAM extension is connected in parallel, a call received by another paralleled telephone can be also picked up.
- When TAM extensions are answering calls simultaneously, you can pick up the call from the extension with the lowest extension number.



- Extension Programming (Section 3.9)
[611] TAM Connection Assignment

2.5 *During a Conversation*

Placing a Call on Hold

Placing a Call on Hold (Call Hold)

Allows you to put a call on hold.

Placing a call on hold

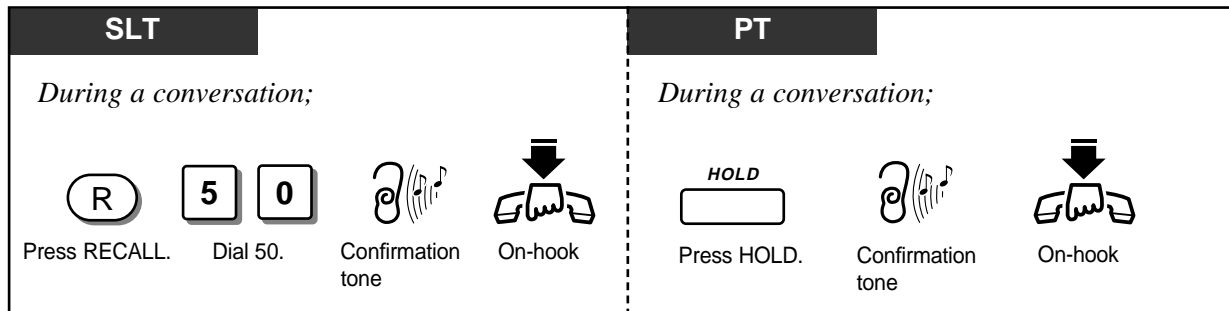

Retrieving a call on hold

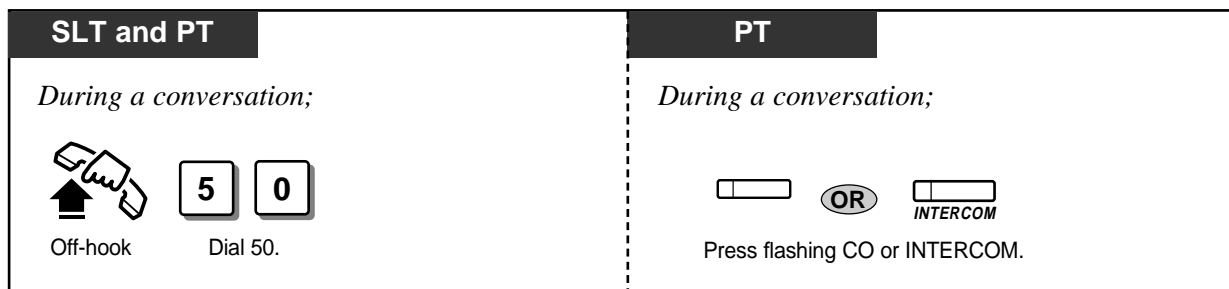

- If a held call is not retrieved in a specific period of time (default: 60 seconds), Hold Recall occurs.
- If an outside call is placed on hold and not retrieved in 15 minutes, it is automatically disconnected.
- Either one outside or intercom call can be placed on hold at the same time. (SLT only)
- While a party is on hold, music is sent automatically.
- If you do not want other extension users to retrieve your call, press the HOLD button twice. Then no one can retrieve your call at the other extension (Exclusive Hold). Exclusive Hold is available only for proprietary telephone users.



- Timer Programming (Section 3.5)
 - [200] Hold Recall Time
- Optional Programming (Section 3.12)
 - [902] System Additional Information

2.5 *During a Conversation*

Retrieving a Call on Hold from Another Telephone (Call Hold Retrieve)

Allows you to retrieve a call that has been placed on hold by another extension.

Retrieving an outside call on hold from another telephone

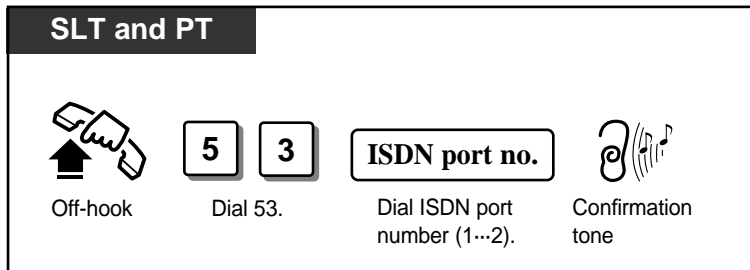

Retrieving an intercom call on hold from another telephone

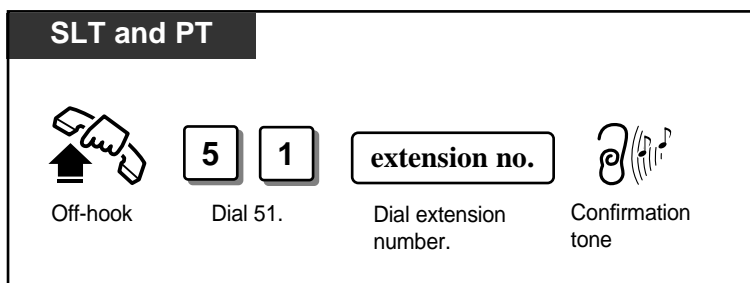

2.5 *During a Conversation*

Placing a Call in a System Parking Area (Call Park)



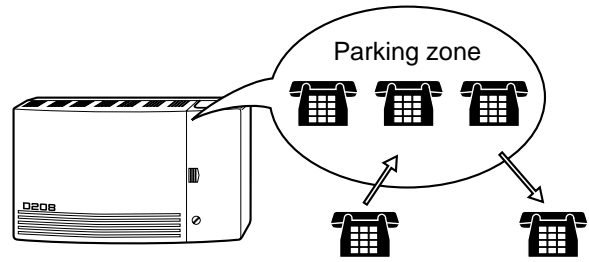



Allows you to place a call on hold into a system parking area. This releases you from the parked call to perform other operations. The parked call can be retrieved by any extension user.



Parking a call

SLT

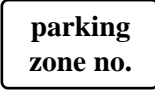





During a conversation;





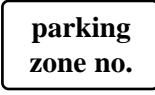

You can perform other operations.

Press **RECALL**. Confirmation tone Dial 52. Dial parking zone number (0...9). Confirmation tone

PT





During a conversation;





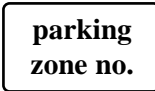

You can perform other operations.

Press **TRANSFER**. Confirmation tone Dial 52. Dial parking zone number (0...9). Confirmation tone

Retrieving a parked call

SLT and PT

Off-hook Dial 52. Dial parking zone number (0...9). Confirmation tone Talk.

2.5 *During a Conversation*



- Up to ten calls can be parked in the system.
- If the selected parking zone is full, a busy tone will be heard. In this case, enter the other parking zone number continuously until you hear a dial tone.
- If a parked call is not retrieved within the Transfer Recall time, Call Park Recall occurs. If a parked call is an outside call, it is possible to select whether the Call Park Recall will occur at the initiating extension or the manager through System Programming. If a parked call is an intercom call, the Call Park Recall will return to the initiating extension.
- If a Call Park Recall is not retrieved within 15 minutes, the held call is automatically disconnected.
- With the KX-T7235, KX-T7433 and KX-T7436, the manager can execute this feature with the display operation.



- Display Operation (Section 2.7)
System Feature List
- Timer Programming (Section 3.5)
[201] Transfer Recall Time
- Optional Programming (Section 3.12)
[902] System Additional Information

2.5 *During a Conversation*

Transferring Calls

Allows you to transfer a call to another destination with or without an announcement.
 You can transfer a call after making a paging announcement.
 Please refer to “Paging” on page 2-38 for details about paging.

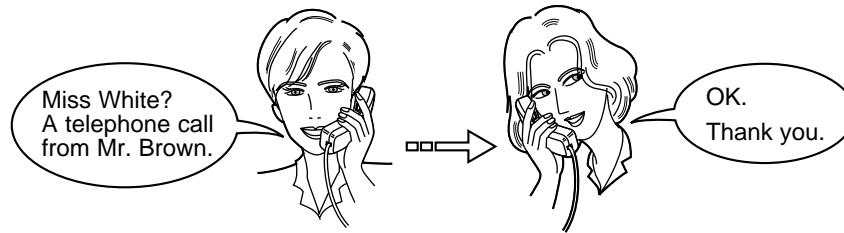

Transferring a Call to an Extension (Call Transfer — to Extension)

SLT

During a conversation;

[Omit if not necessary.]

The diagram for SLT (Speedy Local Transfer) shows the following steps:

- Press **RECALL**. (Icon: 'R' in a circle)
- Confirmation tone. (Icon: ear with musical notes)
- Dial destination extension number. (Icon: box labeled "destination extension no.")
- Wait for an answer. (Icon: person on phone with a lightning bolt, part of a dashed box labeled "[Omit if not necessary.]")
- Announce. (Icon: person on phone with a lightning bolt, part of a dashed box labeled "[Omit if not necessary.]")
- On-hook. (Icon: hand hanging up a phone)

PT

During a conversation;

[Omit if not necessary.]

The diagram for PT (Push Transfer) shows the following steps:

- Press **TRANSFER**. (Icon: button labeled "TRANSFER")
- Confirmation tone. (Icon: ear with musical notes)
- Dial destination extension number. (Icon: box labeled "destination extension no.")
- Wait for an answer. (Icon: person on phone with a lightning bolt, part of a dashed box labeled "[Omit if not necessary.]")
- Announce. (Icon: person on phone with a lightning bolt, part of a dashed box labeled "[Omit if not necessary.]")
- On-hook. (Icon: hand hanging up a phone)

2.5 *During a Conversation*

Transferring a Call to an Extension after Paging

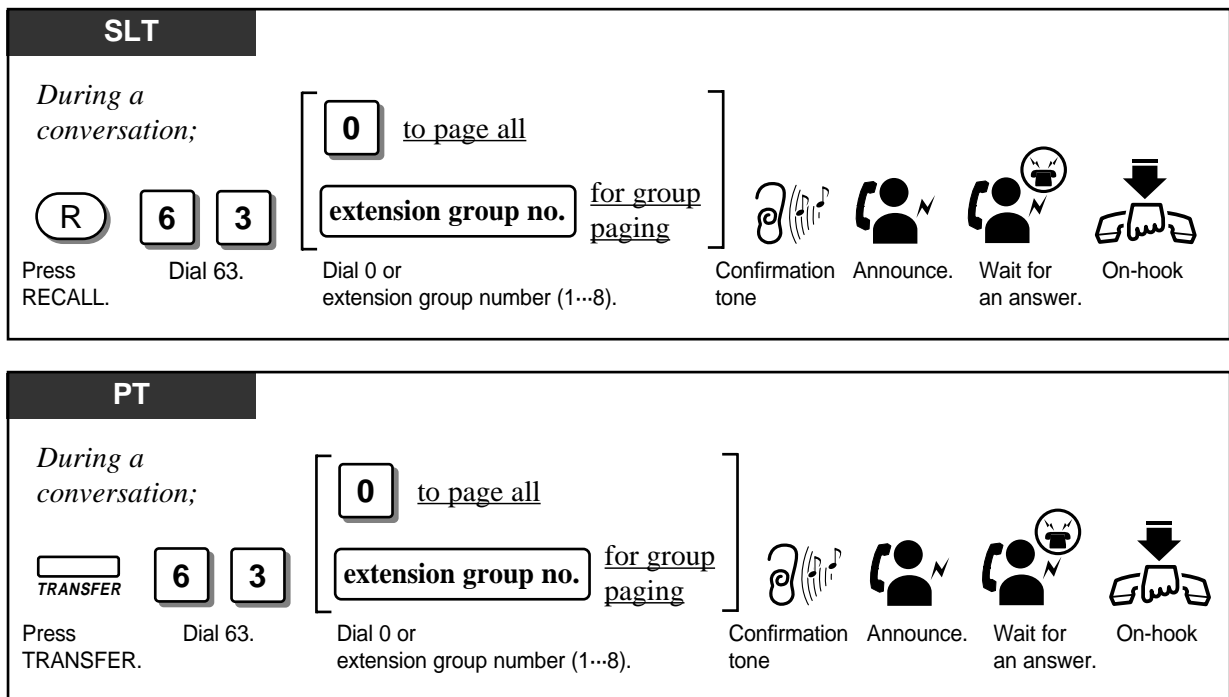

- If you want to return to the held call, press the RECALL button (for SLT/ISDN telephone), TRANSFER, corresponding CO or INTERCOM button (for PT) before the destination extension answers.
- **Transferring a call by the DSS button;**
Proprietary telephone users can also transfer an outside call to an extension simply by pressing the DSS (Direct Station Selection) button, if assigned.
- If the destination extension does not answer the call within 12 rings (default), Transfer Recall occurs. If the transferred call is an outside call, it is possible to select whether the Transfer Recall will occur at the initiating extension or the manager through system optional programming.
- If you do not answer the Transfer Recall within 15 minutes, the line will be disconnected.
- It is system-programmable whether to send a ringback tone or music on hold to the caller while transferring.



- Initial Settings (Section 2.2)
Customising the Buttons on Your Telephone
- Timer Programming (Section 3.5)
[201] Transfer Recall Time
- Optional Programming (Section 3.12)
[902] System Additional Information

2.5 During a Conversation

Transferring a Call to outside line (CO) (Call Transfer — to outside line (CO))

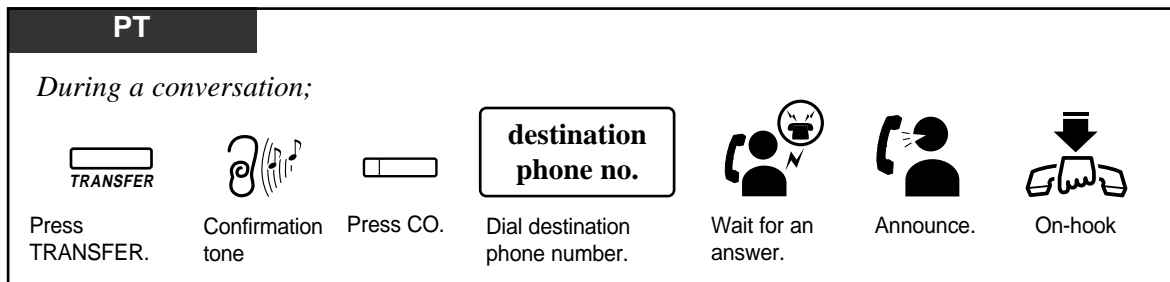

- ! Instead of pressing the CO button, you can dial the ISDN port access code (9, 81 or 82).
- If you want to return to the held call, press the TRANSFER, corresponding CO, or INTERCOM button before the destination extension answers.
- Class of Service determines the extensions that can perform this feature.



- COS Programming (Section 3.8)
[503] Call Forwarding to outside line (CO)

Call Waiting

During a conversation, a Call Waiting tone informs you that there is a call waiting. You may answer the second call by disconnecting or placing the current call on hold.



Setting / Cancelling

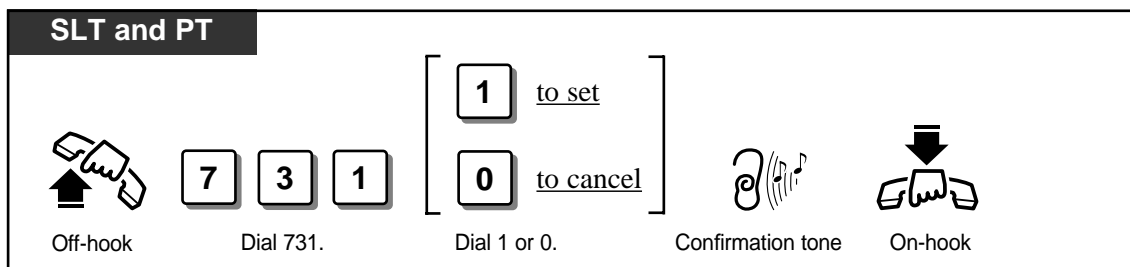

To talk to the new caller by terminating the current call

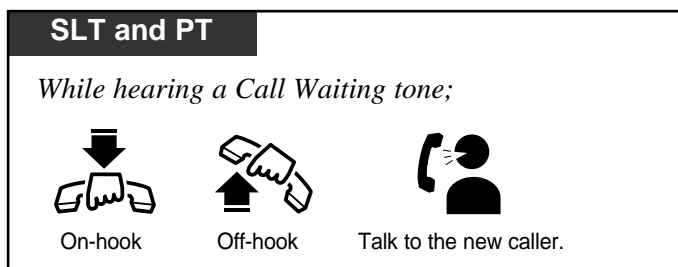







2.5 *During a Conversation*

To talk to the new caller by holding the current call

SLT





While hearing a Call Waiting tone;

Press RECALL. Dial 50. On-hook Off-hook Talk to the new caller.



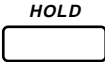

PT

While hearing a Call Waiting tone;

Press HOLD. Press flashing CO or INTERCOM. Talk to the new caller.

While hearing a Call Waiting tone;

Press flashing CO or INTERCOM. Talk to the new caller.



- A Call Waiting tone is generated when an outside call or doorphone call is received, or when another extension executes Busy Station Signalling.
- Setting Data Line Security temporarily cancels this feature.
- You can distinguish the Call Waiting tone received from a outside line (CO) and intercom (Call Waiting Tone Type Selection).



- Initial Settings (Section 2.2)
Customising Your Telephone Functions

2.5 *During a Conversation*

Turning Off the Microphone

During a conversation, either when you are using the handset or in the handsfree mode, you can turn off the microphone so that you can consult privately with others in the room. And you will still be able to hear the other party.

Turning on / off the handset microphone

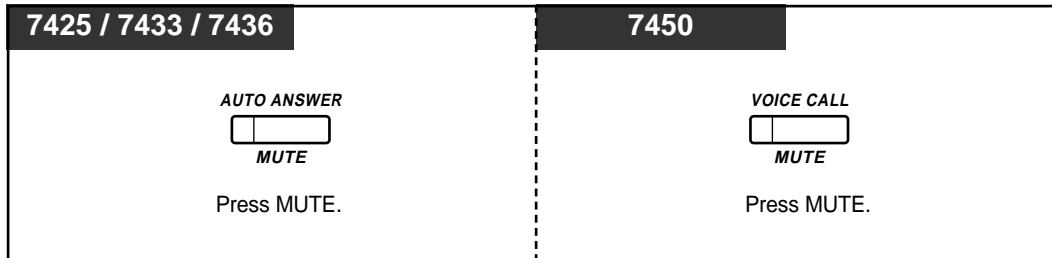

Turning on / off the microphone for the handsfree mode

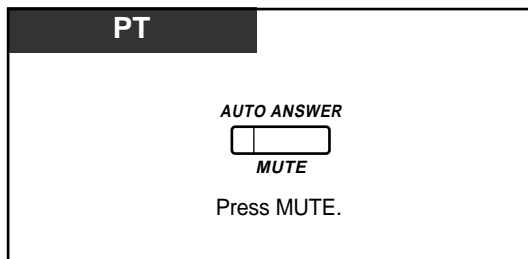

2.6 Others

Paging

Allows you to make a voice announcement to several people at the same time. Your message is announced over built-in speakers of all or a particular group of extensions. The paged person can answer your page from any telephone. You can also transfer a call after paging or deny to be paged.

Paging

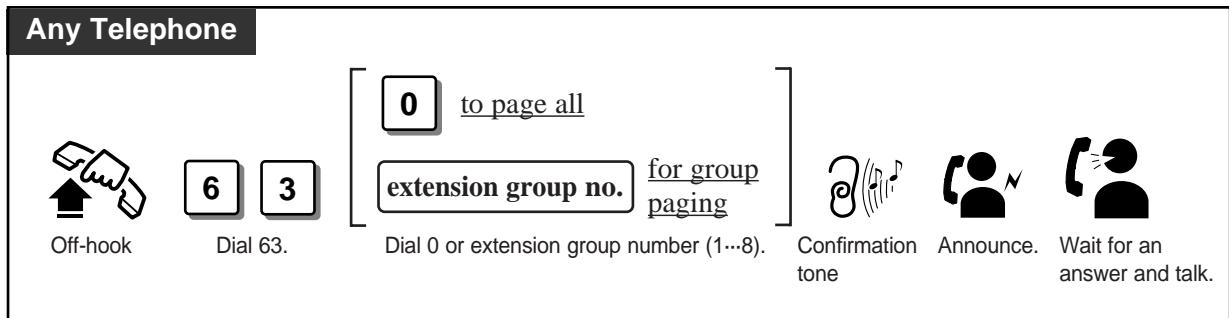

Answering the Page

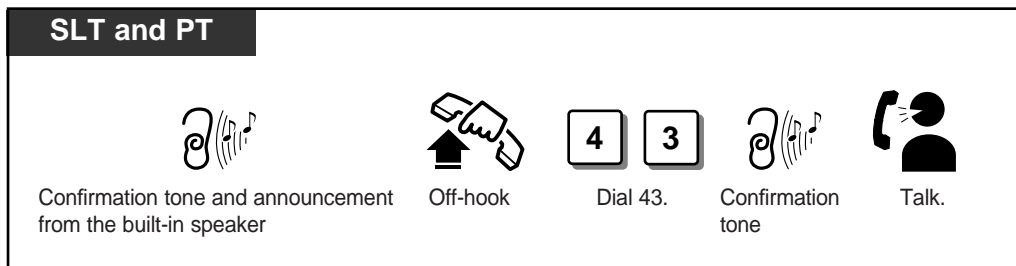

Denying the Page

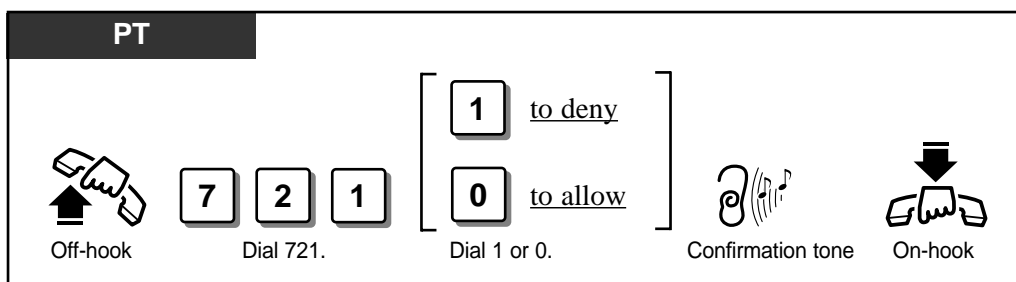

- With the KX-T7235, KX-T7433 and KX-T7436, you can execute the Group Paging feature with the display operation.



- Display Operation (Section 2.7)
System Feature List
- Extension Programming (Section 3.9)
[602] Extension Group Assignment

2.6 Others

Before Leaving Your Desk

Forwarding a Call (Call Forwarding)

Automatically transfers incoming calls to a pre-set destination.

The following types are available:



| TYPE | DESCRIPTION |
|-------------------------------------|--|
| All Calls | All calls are forwarded to another extension. |
| Busy | The calls are forwarded to another extension, when your extension is busy. |
| No Answer | The calls are forwarded to another extension if you don't answer the call within the pre-set time. |
| Busy/No Answer | The calls are forwarded to another extension if your extension is busy or you don't answer the call within the pre-set time. |
| To outside line (CO) | The calls are forwarded to a outside line (CO). |
| Follow Me | Allows you to set "Call Forwarding — All Calls" remotely from the destination extension. |
| By the ISDN Service – all calls* | All calls to your MSN number are forwarded by the ISDN network. |
| By the ISDN Service – when busy* | Calls to your MSN number are forwarded when you are busy, by the ISDN network. |
| By the ISDN Service – no Answer* | If you do not answer calls, calls to your MSN number will be forwarded by the ISDN network. |



- There can only be one stage of Call Forwarding.
- Class of Service determines the extensions that can perform Call Forwarding – to outside line (CO) / Follow Me functions.
- Setting one of the Call Forwarding functions cancels other Call Forwarding or DND functions, if any.
- A flexible button on the proprietary telephone can be assigned as the FWD/DND button.
- With the KX-T7235 and KX-T7436, you can set or cancel all of the Call Forwarding features.
- You can use “* *” to store a PAUSE (0 through 9 and * are assignable.) — Call Forwarding to outside line (CO).



- Initial Settings (Section 2.2)
Customising the Buttons on Your Telephone
- Display Operation (Section 2.7)
Display Operation for FWD/DND Features (KX-T7235/KX-T7436 only)
- Timer Programming (Section 3.5)
[202] Call Forwarding — No Answer Time
- COS Programming (Section 3.8)
[503] Call Forwarding to outside line (CO)
[511] Call Forwarding — Follow Me
[517] Call Forwarding by ISDN Service

*: The availability of this feature depends on your local ISDN services.

2.6 Others

Setting

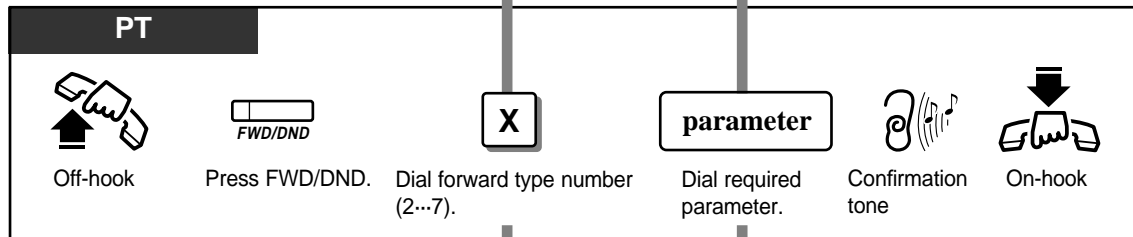
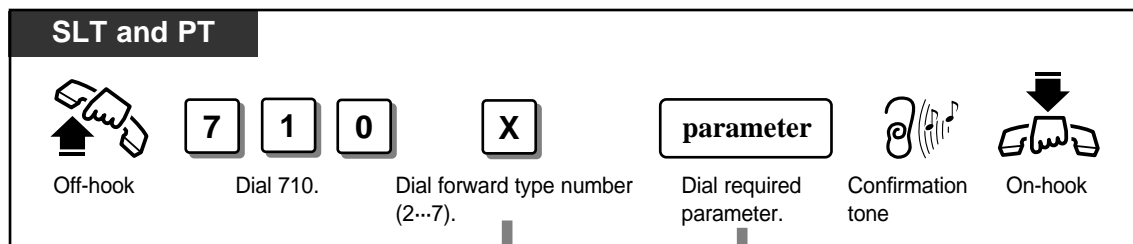

| FORWARD TYPE | FORWARD TYPE No. | PARAMETER |
|---------------------------------|------------------|---|
| All Calls | 2 | <div style="border: 1px solid black; padding: 5px; display: inline-block;"> destination extension no. </div> Dial destination extension number. |
| Busy | 3 | |
| No Answer | 4 | |
| Busy / No Answer | 5 | |
| To outside line (CO) | 6 | — 16 digits max. — <div style="display: flex; justify-content: space-around; align-items: flex-start;"> <div style="border: 1px solid black; padding: 5px; display: inline-block;"> ISDN port access code </div> <div style="border: 1px solid black; padding: 5px; display: inline-block;"> destination phone no. </div> <div style="border: 1px solid black; padding: 5px; display: inline-block;"> # </div> </div> Dial ISDN port access code (9, 81...82). Dial destination phone number. Dial #. |
| Follow Me | 7 | – at the destination extension <div style="border: 1px solid black; padding: 5px; display: inline-block;"> your extension no. </div> Dial your extension number. |
| By the ISDN Service – all calls | 9 2 | <div style="display: flex; justify-content: space-around; align-items: flex-start;"> <div style="border: 1px solid black; padding: 5px; display: inline-block;"> ISDN port number </div> <div style="border: 1px solid black; padding: 5px; display: inline-block;"> destination phone no. </div> <div style="border: 1px solid black; padding: 5px; display: inline-block;"> # </div> </div> Dial ISDN port number (1, 2). Dial destination phone number. Dial #. |
| By the ISDN Service – when busy | 9 3 | |
| By the ISDN Service – no Answer | 9 4 | |

2.6 Others

Canceling

Canceling Call Forwarding at your (original) extension

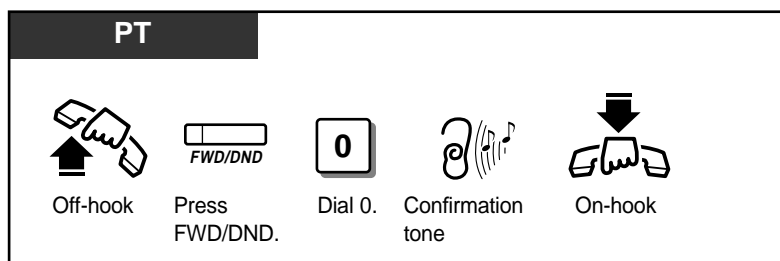
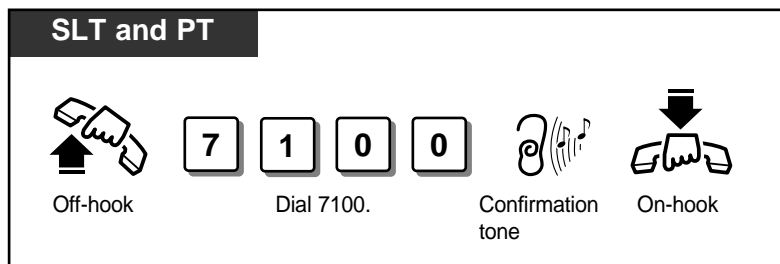

Canceling Call Forwarding at the destination extension – “Follow Me” only

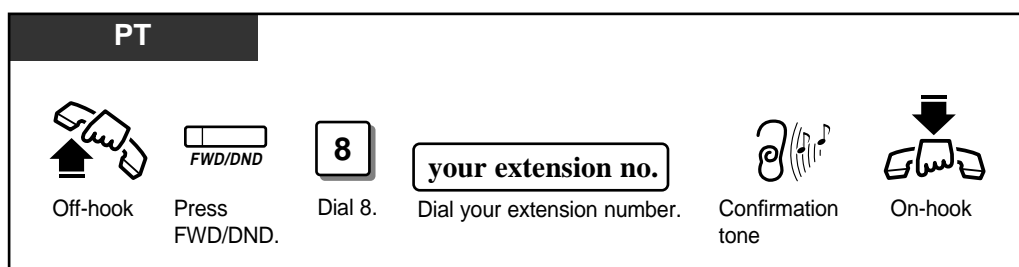
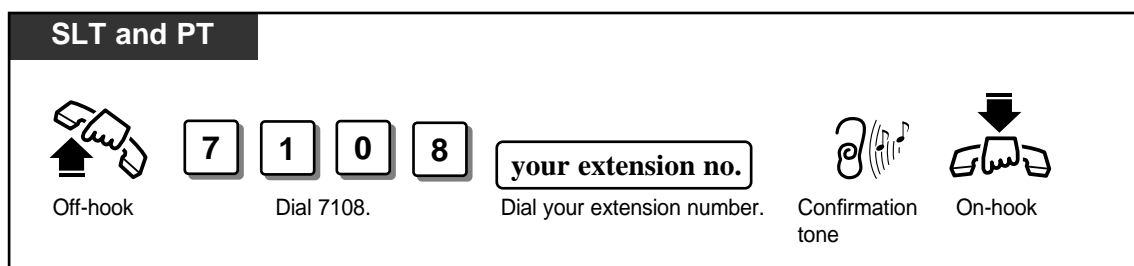

2.6 Others

Locking Your Phone (Electronic Station Lockout)

Allows you to lock your extension so that other users cannot make outside calls. Any 3-digit numeric code is used to lock the extension. The same code is used to unlock the extension.

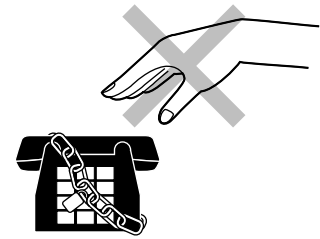

Locking

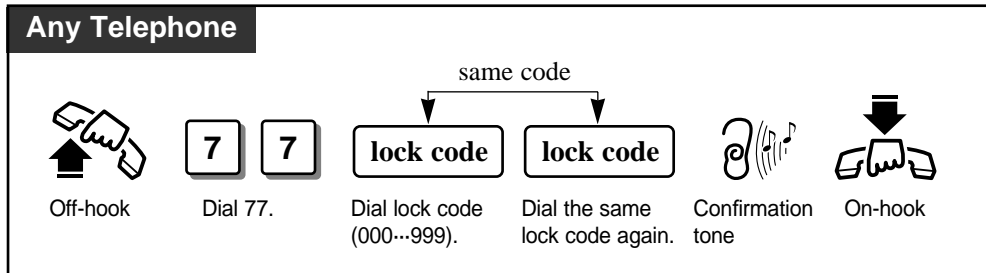

Unlocking

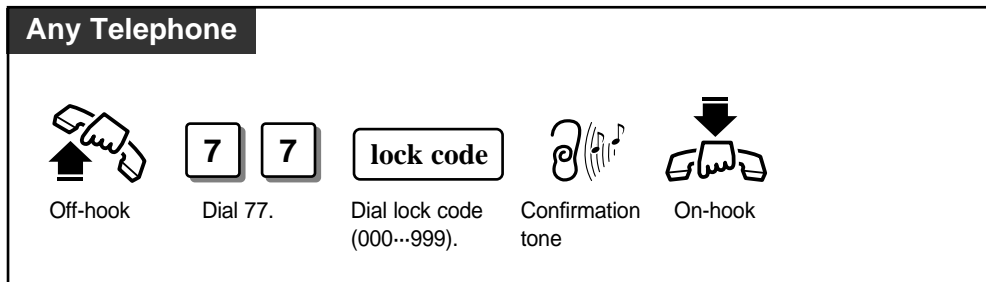

- Making intercom calls and receiving intercom or outside calls are allowed on a locked extension.
- The manager can set and cancel this function for another extension (Controlling “Electronic Station Lockout” Remotely).
- The new setting overrides the old one. If the manager sets Remote Station Lock on an extension it has already been locked, you cannot unlock it.



- Manager Operations (Section 2.8)
Controlling “Electronic Station Lockout” Remotely (Remote Station Lock Control)

2.6 Others

Showing Your Message on the Calling Party's Display (Absent Message Capability)

Callers with display telephones can receive a message why you are absent. There are six pre-programmed default messages. If required, messages 7, 8 and 9 can be programmed using a personal computer (PC Programming, Section 3.13).

Setting the absent message

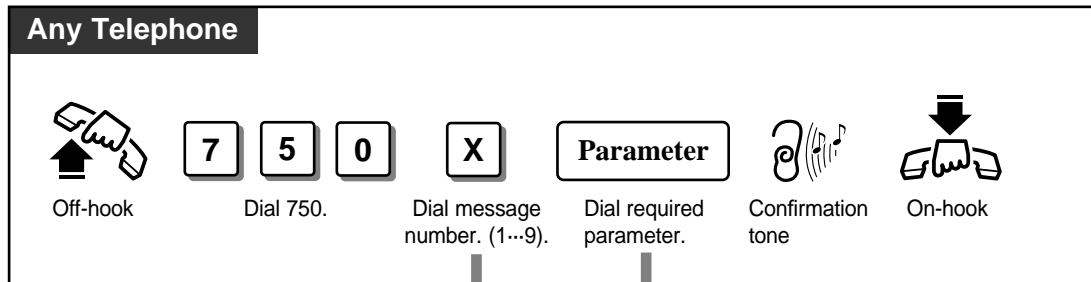

| DISPLAY MESSAGE | MESSAGE NO. | PARAMETER |
|----------------------------|-------------|---|
| Will Return Soon | 1 | None |
| Gone Home | 2 | None |
| At Ext %% | 3 | extension no. Dial extension number. |
| Back at %:%% (time) | 4 | hour minute Enter hour (00...23) and minute (00...59). |
| Out until %/%% (day/month) | 5 | day month Enter day (01...31) and month (01...12). |
| In a Meeting | 6 | None |
| (Programmable) | 7 | |
| (Programmable) | 8 | |
| (Programmable) | 9 | |

Note: % indicates the digit where you enter the desired parameter.

(Continued)

2.6 Others

Cancelling the absent message

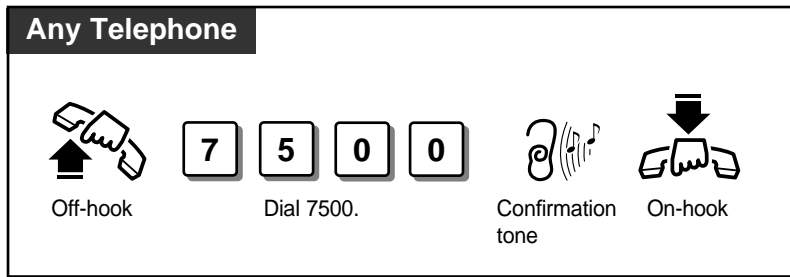

- The display telephone users can see the selected message every time they go off-hook.
- With the KX-T7235, KX-T7433 and KX-T7436, you can execute this feature with the display operation.



- Display Operation (Section 2.7)
System Feature List
- PC Programming (Section 3.13)

2.6 Others

Three-Party Conversation (Conference)

During a two-party conversation, you can add a third party to make a three-party conversation (Conference). You can also leave the conference with the other two parties remaining. If the other two parties are both CO lines, you can join in the conversation again.



- Up to four conference calls are allowed simultaneously.
- The KX-T7250 user can assign the CONFERENCE button as a flexible button.



- Initial Settings (Section 2.2)
Customising the Buttons on Your Telephone

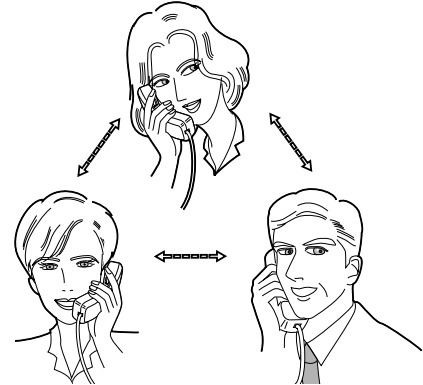

Establishing a Conference

SLT

During a two-party conversation;

| | | | | | | | |
|------------------|----------------------|-------------------------------------|------------------------|------------------|---------|----------------------|---|
| | | third party's phone no. | | | | | <u>A three-party conference is now established.</u> |
| Press RECALL. | Confirmation tone | Dial third party's phone number. | Wait for an answer. | Press RECALL. | Dial 3. | Confirmation tone | |

PT

During a two-party conversation;

| | | | | | | |
|----------------------|----------------------|-------------------------------------|------------------------|----------------------|----------------------|---|
| | | third party's phone no. | | | | <u>A three-party conference is now established.</u> |
| Press CONFERENCE. | Confirmation tone | Dial third party's phone number. | Wait for an answer. | Press CONFERENCE. | Confirmation tone | |





- When you dial the telephone number of an outside party, you must dial the ISDN port access code (9, 81 or 82) as the leading digit.
- You can return to the original party before the third party answers by pressing the RECALL button or TRANSFER button.
- If you are having a conference with at least one outside party, you can put both parties on hold by pressing the HOLD button.

(Continued)





2.6 Others

Making a three-party a two-party conversation

Terminating one party and talking to the other (not available for three extension calls)

| PT | |
|---|---|
|  |  |
| <p>Press CO or INTERCOM you want to remain connected.</p> | <p>Confirmation tone</p> |
| <p><u>Conversation with the desired party is established and the other party is disconnected.</u></p> | |

Talking to the first caller while keeping the second call on hold

| SLT | PT |
|---|---|
|  |  |
| <p>Press RECALL.</p> | <p>Press TRANSFER.</p> |
|  |  |
| <p>Confirmation tone</p> | <p>Confirmation tone</p> |
| <p><u>You can talk to the original party.</u></p> | <p><u>You can talk to the original party.</u></p> |

Leaving the Conference

Leaving the conference with the other two parties remaining (unless both are outside parties)

| SLT and PT |
|--|
|  |
| <p>On-hook</p> |
| <p><u>If the other two parties are both CO lines, they will be disconnected.</u></p> |

Leaving the conference with the other two outside parties remaining (Unattended Conference)

| PT |
|---|
|  |
| <p>Press CONFERENCE.</p> |

Rejoining an Outside Two Party Conference

| PT |
|---|
|  |
| <p>Press CO flashing green moderately.</p> |



- Class of Service determines the extensions that can perform Unattended Conference.



- COS Programming (Section 3.8)
[503] Call Forwarding to outside line (CO)

2.6 Others

Alarm Setting (Timed Reminder)

Each extension can be set to generate an alarm ringing at a preset time as a wake up alarm or a reminder. You can set this to be activated once or every day at a preset time.



Setting

SLT and PT



7
6
1
hour
minute
0
1
Confirmation tone
On-hook

Off-hook Dial 761. Enter hour (00...23). Enter minute (00...59). Dial 0 or 1. Confirmation tone On-hook

0 for a one time alarm
 1 for a daily alarm

Cancelling

SLT and PT

7
6
0
Confirmation tone
On-hook

Off-hook Dial 760. Confirmation tone On-hook

Stopping the alarm

SLT and PT



Off-hook

Checking the set time on the display

PT with display

7
6
2
The display shows the set time.
On-hook

Off-hook Dial 762. On-hook



- The alarm ringing continues for 30 seconds.
- If you receive an incoming outside call in the 1:N status during the alarm, ringing starts after the alarm stops sounding.
- When the preset time comes during a call, the alarm starts after the call is completed.

2.6 Others

Turning On the Background Music (Background Music (BGM))

Allows you to hear background music through the built-in speaker of the telephone while in on-hook status. The music stops whenever a call comes in or when you go off-hook.

Turning on / off

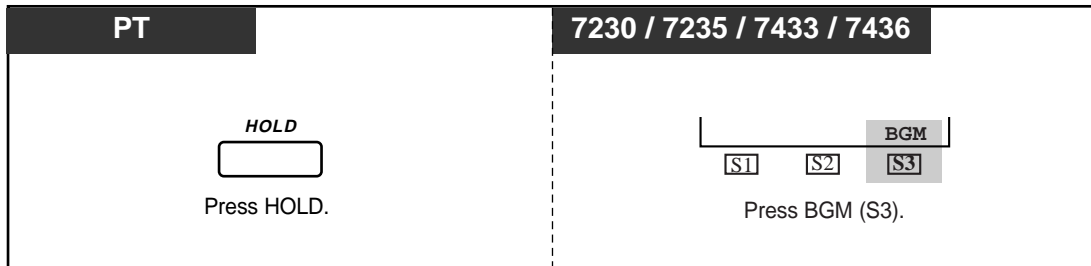

- Resource Programming (Section 3.11)
[803] Music Source Use

2.6 Others

Leaving a Message Notification (Message Waiting)

Allows you to inform the called party of a message waiting. For single line and ISDN telephone users, special ringing and Dial Tone 4 are provided to indicate that a message has been received. If your telephone is provided with a message waiting lamp (MESSAGE indicator), it gives visual indication of a message waiting.



Leaving a message notification

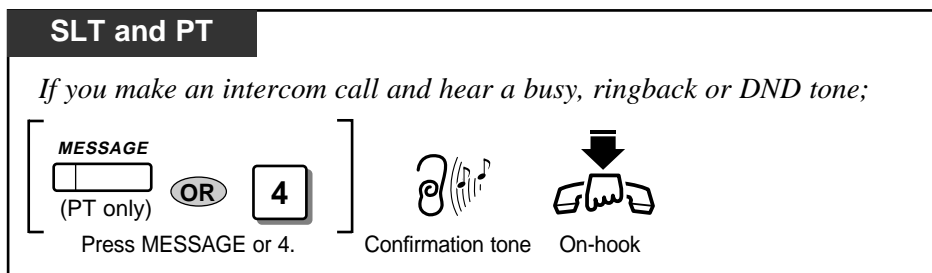
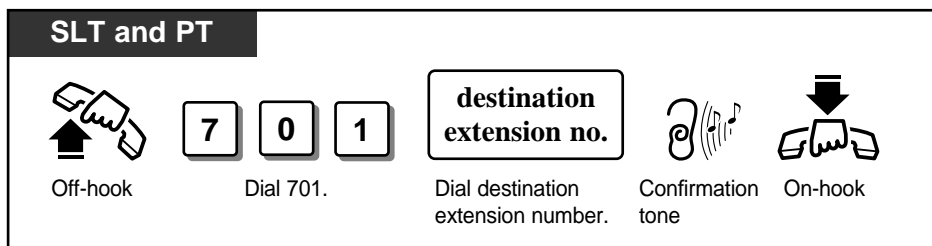

Cancelling a message notification

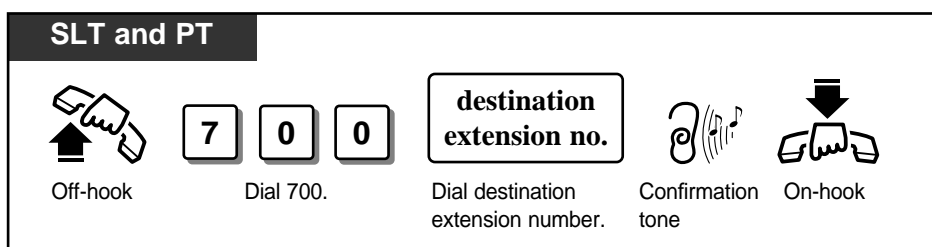

Checking and selecting a message by the receiver on the display

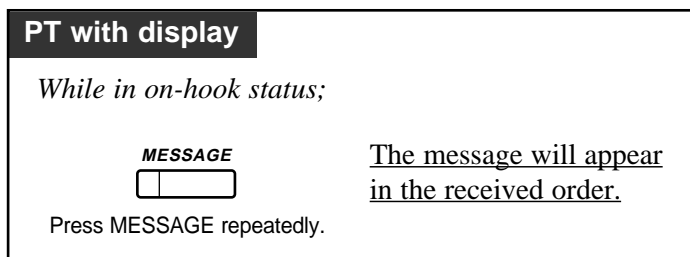

2.6 Others

Calling back the message sender

SLT and PT

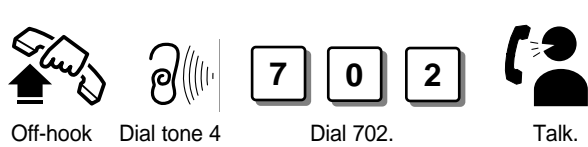

Off-hook Dial tone 4 Dial 702. Talk.

The message is cleared after the conversation.

PT

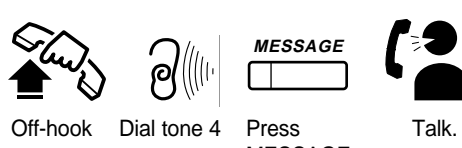

Off-hook Dial tone 4 Press MESSAGE. Talk.

The message is cleared after the conversation.

Clearing all messages by the message receiver

SLT and PT

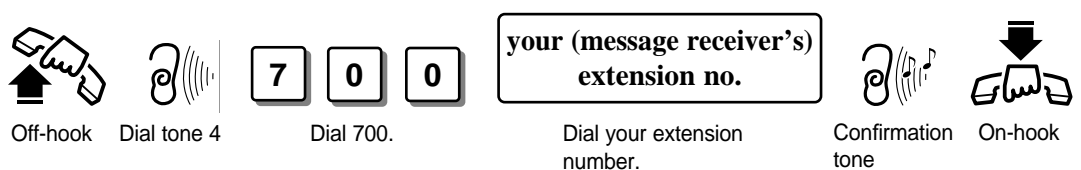

Off-hook Dial tone 4 Dial 700. Dial your extension number. Confirmation tone On-hook

- ! If multiple messages are left at your extension, calling back is executed in the received order.
- The system supports a maximum of 64 simultaneous messages. If you try to set a 65th message, you will hear a reorder tone.
- The special ringing tone for single line rings three times at 5 second intervals. Then there is an interval whose length is programmable.
- A proprietary telephone user can assign the MESSAGE button on a flexible button.
- With the KX-T7235, KX-T7433 and KX-T7436, you can execute this feature with the display operation.



- Initial Settings (Section 2.2)
Customising the Buttons on Your Telephone
- Display Operation (Section 2.7)
System Feature List
- Timer Programming (Section 3.5)
[207] Message Waiting Ring Interval Time

2.6 Others

Calling with Account Codes (Account Code Entry)

An Account Code is used to identify outside calls for accounting and billing purposes. The account code is appended to the Station Message Detail Recording (SMDR) call record. For incoming outside calls, an account code is optional. For outgoing outside calls, there are three modes available to enter an account code as follows. One mode is selected on a Class of Service basis.

In Verified - All Calls mode, you must always enter a pre-assigned account code when making any of the following calls unless it has previously been stored in memory.

- Manual Dialling (Selecting an ISDN port)
- Call Forwarding — to outside line (CO)
- Pickup Dialling (SLT)
- One-Touch Dialling (PT)
- Last Number Redial
- Saved Number Redial (PT)
- Station Speed Dialling
- System Speed Dialling

In Verified - Toll Restriction Override mode, you must enter a pre-assigned account code to override toll restriction (Toll Restriction Override by Account Code Entry).

In Option mode, you can enter any account code when needed.

Entering account codes before dialling

Any Telephone

Off-hook. Dial 49. Enter account code (5 digits max., 0-9). Dial #. Confirmation tone. Dial ISDN port access code (9, 81-82). Dial phone number.

PT

Off-hook. Press Account. Enter account code (5 digits max., 0-9). Dial #. Confirmation tone. Press CO. Dial phone number.

7230 / 7235 / 7433 / 7436

Off-hook. Press ACCNT (S3). Enter account code (5 digits max., 0-9). Dial #. Confirmation tone. Press CO. Dial phone number.

(Continued)

2.6 Others

Entering account codes during or after a conversation

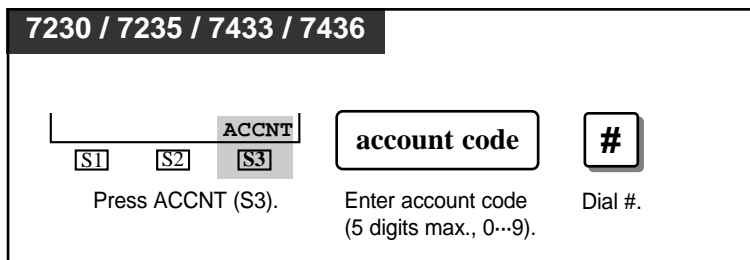
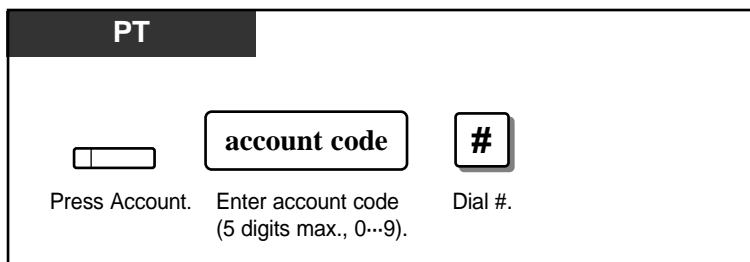

- Entering an account code after a conversation must be performed while hearing the reorder tone and completed within 15 seconds.
- Entering “*” while entering an account code allows you to clear the number and re-enter it again.
- The delimiter, “99,” can be entered instead of “#” after entering an account code.
- An account code can be stored into Memory Dialling (e.g. System/Station Speed Dialling).
- If an entered account code does not match a stored account code in Verified – All Calls or Verified – Toll Restriction Override mode, a reorder tone is heard.
- The proprietary telephone user can assign the Account button on a flexible button.



- Initial Settings (Section 2.2)
 - Customising the Buttons on Your Telephone
- System Programming (Section 3.4)
 - [101] Account Codes
- COS Programming (Section 3.8)
 - [505] Account Code Entry Mode

2.6 Others

Referring to the Charges (Charge Fee Reference)

Allows you to refer to the charges for each extension, outside line (CO), account code or department code. The data can be printed out by Station Message Detail Recording (SMDR) or cleared by each extension.

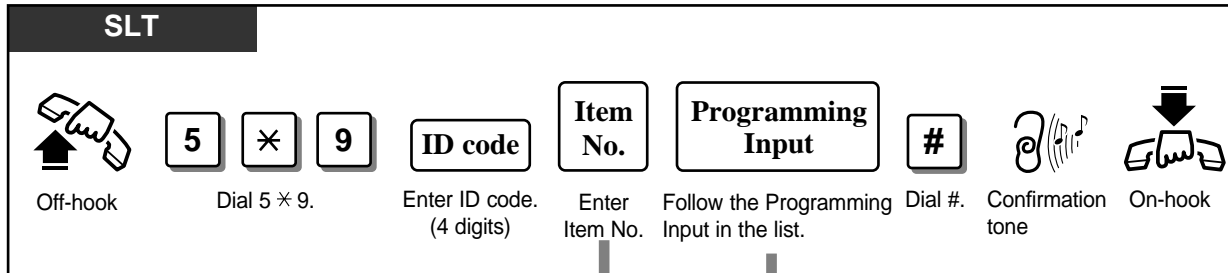

| Item | Item No. | Programming Input |
|---|----------|--|
| Clears the extension charge fee meter. | 1 | extension no. Dial extension number. |
| Clears the account code charge fee meter. | 4 | account code table no. Enter account code table number. (01...40) |
| Sets the new rate. (XXXXXXXX) | 5 | ISDN port no. (1...2, *) new rate (XXXXXXXX) (The decimal point is a floating digit.) |
| Clears all charges except the extension charge. | 6 1 | None |
| Clears all extension charges. | 6 2 | None |
| Prints all charges except the extension charge. | 7 1 | None |
| Prints all extension charges. | 7 2 | None |
| Prints an extension charge. | 7 3 | extension no. Dial extension number. |
| Clears the department code charge fee meter. | 9 | department code Enter department code. (5 digits max) |

(Continued)

2.6 Others

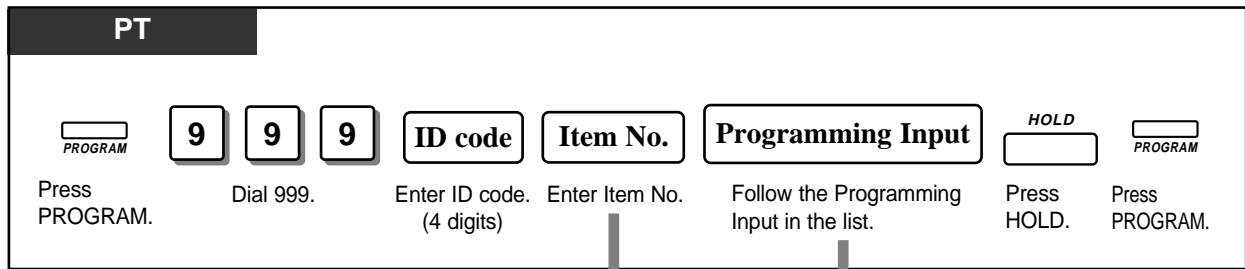

| Item | Item No. | Programming Input |
|---|---|---|
| Refers to the extension charge fee. | <input type="button" value="1"/> | <input type="text" value="extension no."/> Dial extension number. |
| Clears the extension charge fee meter. | <input type="button" value="1"/> | <input type="text" value="extension no."/> <input type="button" value="TRANSFER"/> <input type="button" value="AUTO DIAL STORE"/> Dial extension number. Press TRANSFER. Press STORE. |
| Refers to the CO charge fee. | <input type="button" value="2"/> | <input type="text" value="ISDN port no."/> Dial ISDN port number (1...2). |
| Refers to the total charge fee. | <input type="button" value="3"/> | None |
| Refers to the account code charge fee. | <input type="button" value="4"/> | <input type="text" value="account code table no."/> Enter account code table number. (01...40) |
| Clears the account code charge fee meter. | <input type="button" value="4"/> | <input type="text" value="account code table no."/> <input type="button" value="TRANSFER"/> <input type="button" value="AUTO DIAL STORE"/> Enter account code table number. (01...40) Press TRANSFER. Press STORE. |
| Sets the new rate. (XXXXXXXX) | <input type="button" value="5"/> | <input type="text" value="ISDN port no."/> <input type="text" value="new rate (XXXXXXXX)"/> <input type="button" value="AUTO DIAL STORE"/> (1...2, *) (The decimal point is a floating digit.) Press STORE. |
| Clears all charges except the extension charge. | <input type="button" value="6"/> | <input type="button" value="AUTO DIAL STORE"/> Press STORE. |
| Clears all extension charges. | <input type="button" value="6"/> | <input type="button" value="SP-PHONE"/> <input type="button" value="AUTO DIAL STORE"/> Press SP-PHONE. Press STORE. |
| Prints all charges except the extension charge. | <input type="button" value="7"/> <input type="button" value="1"/> | None |
| Prints all extension charges. | <input type="button" value="7"/> <input type="button" value="2"/> | None |
| Prints an extension charge. | <input type="button" value="7"/> <input type="button" value="3"/> | <input type="text" value="extension no."/> Dial extension number. |

2.6 Others

| ITEM | ITEM No. | PROGRAMMING INPUT |
|--|----------|---|
| Sets the new account code. | 8 | <div style="display: flex; justify-content: space-between; align-items: flex-start;"> <div style="border: 1px solid black; padding: 2px; text-align: center;"> account code table no. </div> <div style="text-align: center;"> <input type="text"/> <small>TRANSFER</small> </div> <div style="border: 1px solid black; padding: 2px; text-align: center;"> new account code </div> <div style="text-align: center;"> <input type="text"/> <small>AUTO DIAL STORE</small> </div> </div> <p>Enter account code table number. (01...40) Press TRANSFER. Enter new account code. Press STORE.</p> |
| Refers to the department code charge fee. | 9 | <div style="border: 1px solid black; padding: 2px; text-align: center;"> department code </div> <p>Enter department code. (5 digits max)</p> |
| Clears the department code charge fee meter. | 9 | <div style="display: flex; justify-content: space-between; align-items: flex-start;"> <div style="border: 1px solid black; padding: 2px; text-align: center;"> department code </div> <div style="text-align: center;"> <input type="text"/> <small>TRANSFER</small> </div> <div style="text-align: center;"> <input type="text"/> <small>AUTO DIAL STORE</small> </div> </div> <p>Enter department code. (5 digits max) Press TRANSFER. Press STORE.</p> |



- Display telephone users can see the messages on the display and program by pressing following buttons.
 - TRANSFER: Erases an incorrect ID code.
 - SP-PHONE: Advances to the next extension, outside line (CO), account code table and department code number.
 - REDIAL: Returns to the step before or after entering the ID code.
 - AUTO ANSWER/MUTE: Alternates between the meter display and the charge display.
- Before referring to the total charge fee at an extension, the same charge rate must be set at each ISDN port. If the charge rate is not set, the charging cannot be done properly.



- System Programming (Section 3.4)
 - [101] Account Codes
 - [107] Charge Indication Selection
 - [108] Charge Verification ID Code Set
- Extension Programming (Section 3.9)
 - [613] Department Codes

2.6 Others

Denying Receiving Calls

Rejecting Incoming Calls (Do Not disturb (DND))

Allows you to reject incoming extension calls by sending the DND tone. Incoming outside calls will be automatically transferred to a pre-assigned extension.

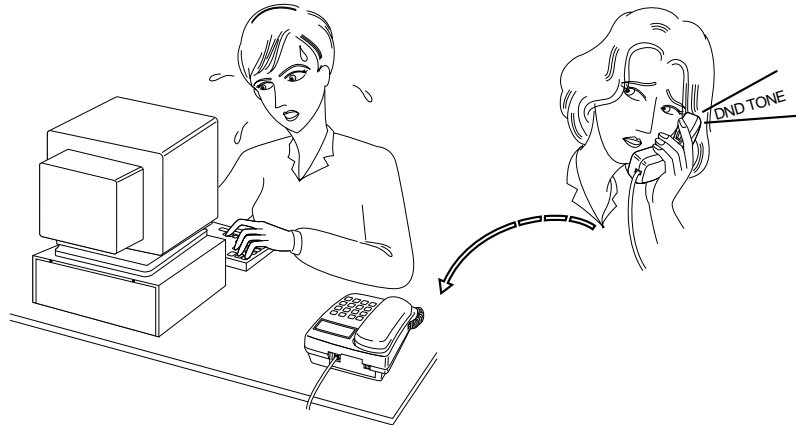

Setting

SLT and PT

Off-hook  **7** **1** **0** **1** Dial 7101.



destination extension no.

0 to forward a call to the destination extension



***** to forward a call to a manager

***** to reject receiving incoming calls

Dial destination extension number, 0 or *.

Confirmation tone  On-hook tone 

PT

Off-hook   **1** Dial 1.

Press FWD/DND.



destination extension no.

0 to forward a call to the destination extension

***** to forward a call to a manager

***** to reject receiving incoming calls

Dial destination extension number, 0 or *.

Confirmation tone  On-hook tone 

2.6 Others

Cancelling

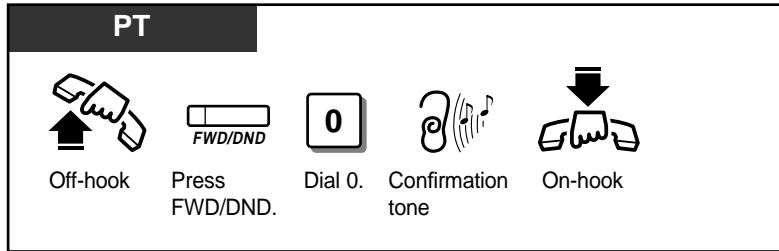
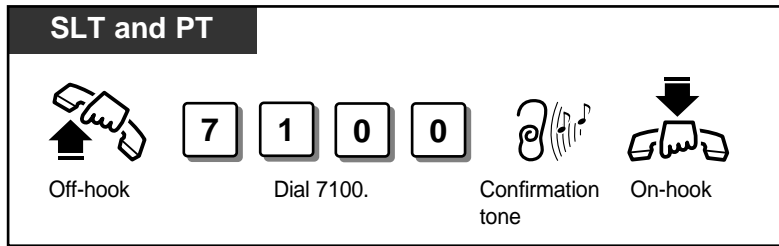

- DND does not work for the following calls: doorphone calls; recalls for hold; Timed Reminder alarm.
- An extension in the DND mode can be called by other extension users who are allowed to override DND in their Class of Service (Do Not Disturb Override).
- The following extensions cannot set DND: the manager, Call Forwarding (C.FWD) destination or the DND destination.
- When the extension has set the C.FWD, DND or DND for Direct Dialling In Calls, the extension cannot be a DND destination.
- Setting this feature cancels C.FWD or DND for Direct Dialling In Calls.
- A flexible button on a proprietary telephone can be assigned as the FWD/DND button.
- KX-T7235 and KX-T7436 users can set or cancel DND with the display operation.
- If an intercom call comes in, the caller hears a DND tone.

When you set DND by dialling “*”;

- If an intercom call comes in, the caller hears a DND tone.
- If you receive an incoming outside call in the 1:N status, the CO button flashes red but does not ring.
- Your extension does not receive incoming outside calls in the 1:1 status.
- Depending on the kind of call received, the DND setting will work differently.

| Call Type | At your extension | At the other party's extension |
|---|---|--------------------------------|
| Intercom Call | No ring | DND tone |
| Outside Call at 2 or more extensions (including your extension) | No ring. Informs you with a flashing CO button. | Ringback tone |
| Outside Call only at your extension | Not received | Busy tone |



- Initial Settings (Section 2.2)
Customising the Buttons on Your Telephone
- Display Operation (Section 2.7)
Display Operation for FWD/DND Feature

2.6 Others

Rejecting a Direct Dialling In Call (DND for DDI Calls)

Allows the pre-assigned extension user to reject a direct dialling in call (DDI call). The rejected call will be transferred to the manager. The manager cannot reject a DDI call. This feature is one of ISDN services.

Setting / Cancelling

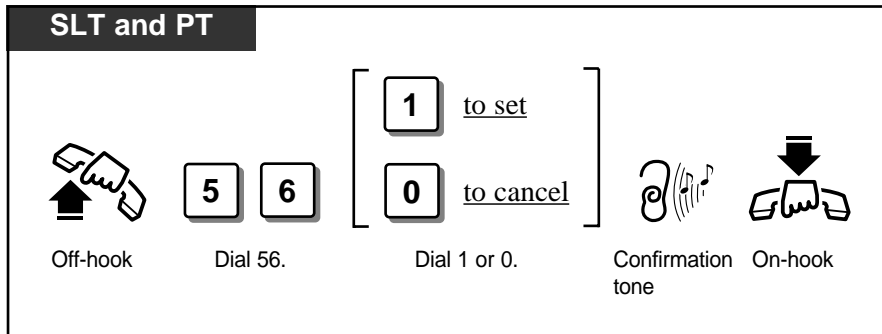

- Setting this feature cancels Call Forwarding or DND.
- Even if this feature is set, your extension doesn't deny DDI calls in the following cases:
 - 1) The destination of the DDI call is an UCD group or a Ring Group.
 - 2) The destination of the DDI call is a Hunting group member that is set to this feature.
- Setting this feature sends dial tone 2 when you lift the handset.
- Class of Service determines the extensions that can perform this feature.







- COS Programming (Section 3.8)
[510] Do Not Disturb for Direct Dialling In Call

2.6 Others

Calling an Extension which Denies Receiving Calls (Do Not Disturb Override)

Allows the pre-assigned extension user to call an extension which sets the Do Not Disturb (DND) feature.

| SLT and PT | 7230 / 7235 / 7433 / 7436 |
|---|--|
| <p><i>If you make an intercom call and hear the Do Not Disturb (DND) tone;</i></p> <div data-bbox="268 757 328 815"></div> <p>Dial 2.</p> <div data-bbox="376 734 464 815"></div> <p>Wait for an answer and talk.</p> | <p><i>If you make an intercom call and hear the Do Not Disturb (DND) tone;</i></p> <div data-bbox="884 748 1134 815"></div> <p>Press OVER (S2).</p> <div data-bbox="1166 734 1254 815"></div> <p>Wait for an answer and talk.</p> |



- If you hear a reorder tone after dialling 2, this means the Do Not Disturb (DND) Override feature is not set at your extension.
- You must dial 2 within 10 seconds after hearing the Do Not Disturb (DND) tone.
- Class of Service determines the extensions that can perform this feature.



- COS Programming (Section 3.8)
[504] Do Not Disturb Override

2.6 Others

Privacy Feature

Restricting Displaying your Number to the Called Party (Calling Line Identification Restriction – CLIR)

Allows you to restrict displaying your number to the called party when making a call (Calling Line Identification Presentation, CLIP – case by case). You can set the called party to see your number on the display once or in succession. This feature is one of ISDN services.

To restrict displaying your number to the called party

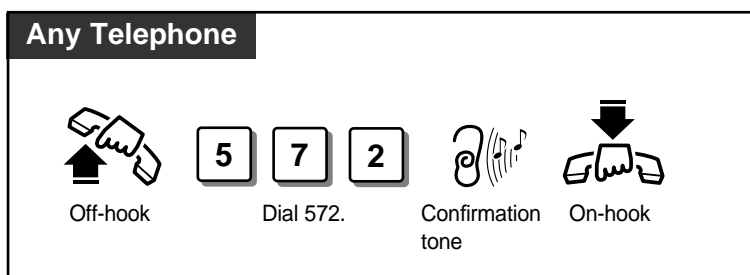

To display your number to the called party

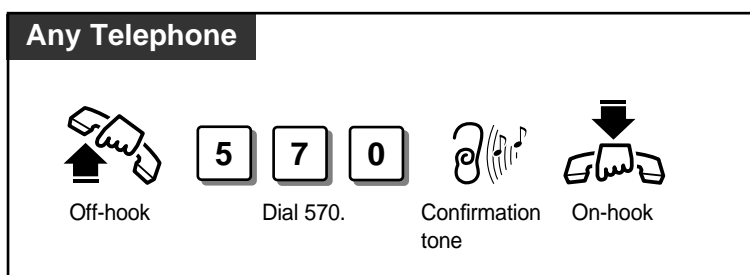

To change the current setting at the time you make a call

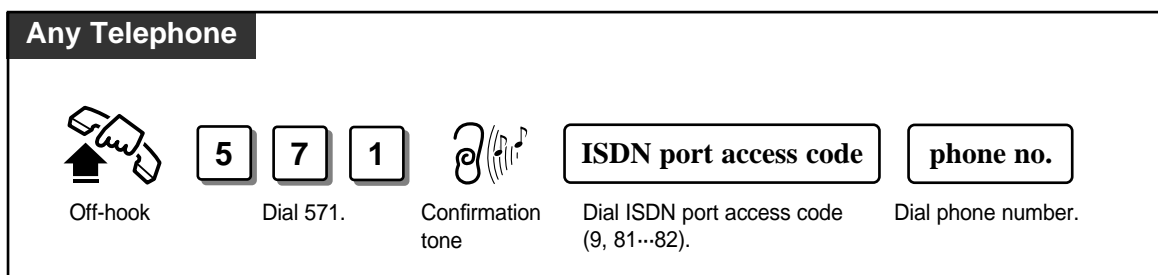

- ISDN Port Programming (Section 3.7)
 - [404] CLIP/COLP Number Assignment
- COS Programming (Section 3.8)
 - [512] Calling Line Identification Restriction (CLIR)
- Please refer to “Caller Identification Services (for KX-T7230/KX-T7235/KX-T7433/KX-T7436)” (page 2-68) and “Setting the CLIP/COLP numbers” (page 2-76).

2.6 Others

Restricting Displaying your Number to the Calling Party (Connected Line Identification Restriction – COLR)

Allows you to restrict displaying your number to the calling party when you receive an incoming call. This feature is one of ISDN services.

To restrict displaying your number to the calling party

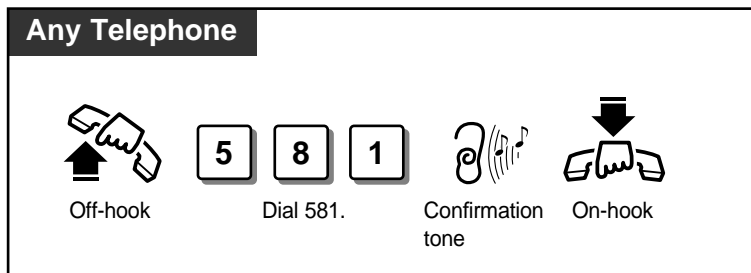

To display your number to the calling party

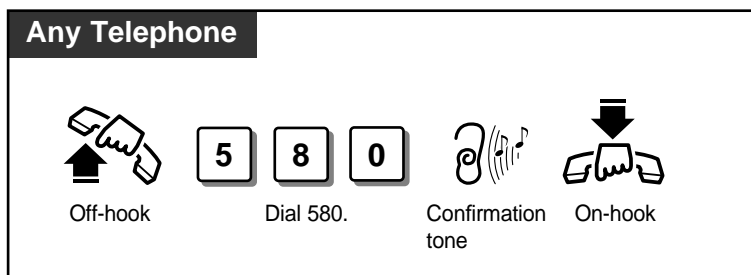

- ISDN Port Programming (Section 3.7)
 - [404] CLIP/COLP Number Assignment
- COS Programming (Section 3.8)
 - [513] Connected Line Identification Restriction (COLR)

2.6 Others

Doorphone Call

If a visitor presses the Call button on the doorphone, pre-assigned extensions will ring. It is possible for any extension user to call a doorphone.

Answering a doorphone call

Any Telephone

When you hear the doorphone ring tone;



Off-hook

Calling a doorphone

Any Telephone



Off-hook



Dial 68.



Confirmation tone



Talk to the visitor.



- It is necessary to install the KX-T30865 doorphone.
- It is necessary to program the extensions that can receive calls from the doorphone during day and night modes. Otherwise, the ISDN extensions cannot be programmed to receive doorphone calls. Calling a doorphone or picking up a doorphone call is possible for any extension.
- If no extension user answers an incoming doorphone call within 30 seconds, the call is cancelled.
- You can unlock the door from your extension to let the visitor in (Door Opener).



- Extension Programming (Section 3.9)
[607]–[608] Doorphone Ringing Assignment — Day/Night
- Connecting the Doorphone and Door Opener (Section 4.14)

2.6 Others

Unlocking a Door (Door Opener)

Allows you to unlock the door for a visitor from your extension.

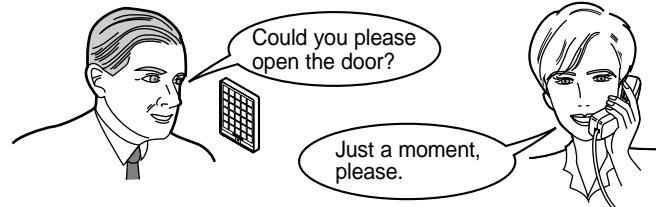

To unlock the door

Any Telephone



Off-hook



Dial 55.



Confirmation tone

The door is left unlocked for 5 seconds.

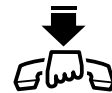

On-hook

To unlock the door while talking to the doorphone

SLT

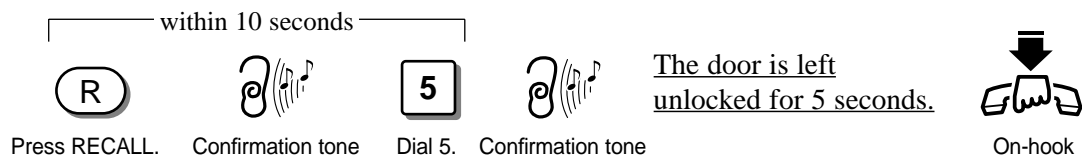

PT



Dial 5.



Confirmation tone

The door is left unlocked for 5 seconds.



On-hook



- It is necessary to install a user-supplied door opener at each door to be opened.
- When a visitor presses the Call button on the doorphone, the system may automatically open the door, if the doorphone has a built-in door opener. This is required to be set by System Programming.
- Class of service determines the extensions that can perform this feature.
- Unlocking the door while talking to the doorphone is not possible with ISDN telephones. You must hang up and unlock the door by entering the feature number "55."
- You can change the door open time from 0 to 99 seconds by System Programming.



- System Programming (Section 3.4)
 - [105] Automatic Door Open Assignment
- Timer Programming (Section 3.5)
 - [206] Door Opener Time
- COS Programming (Section 3.8)
 - [508] Door Opener Access
- Connecting the Doorphone and Door Opener (Section 4.14)

2.6 Others

Switching the Day/Night Calling Mode (Night Service)

The system operation for originating and receiving calls can be different for day and night modes. Toll Restriction calls can be arranged separately to prevent unauthorised toll calls at night.

Day / Night mode can be switched either automatically at a pre-assigned time or manually at any time desired by pre-assigned extension or the manager.

Class of Service determines the extensions that can perform it.

Automatic Night Service: Your system will switch on the Day / Night mode at the programmed time each day.

Manual Night Service: The manager and pre-assigned extension can switch on the Day / Night mode manually.

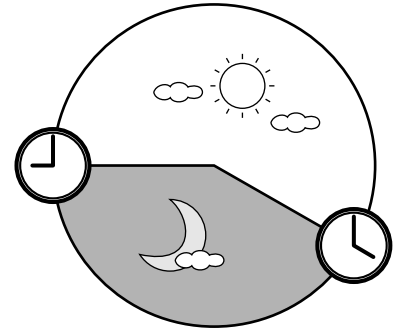

Selecting the Night Service mode

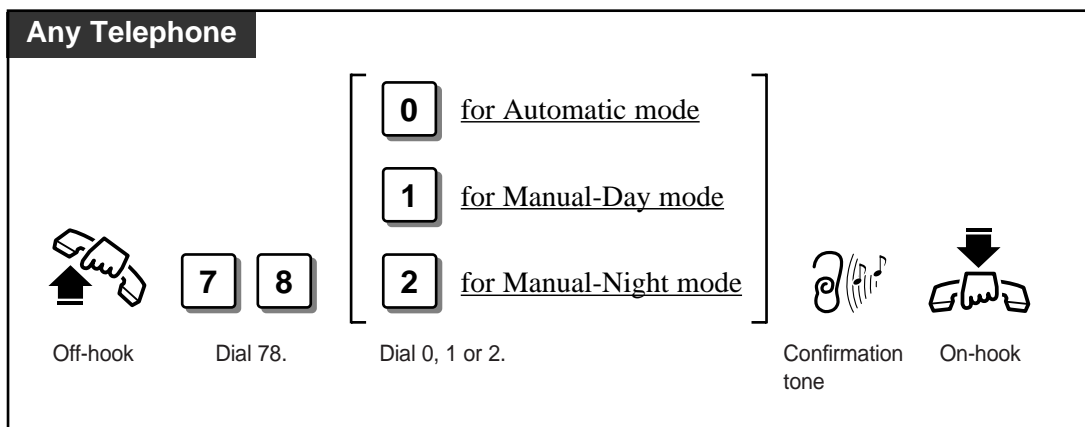

Confirming the current mode on the display

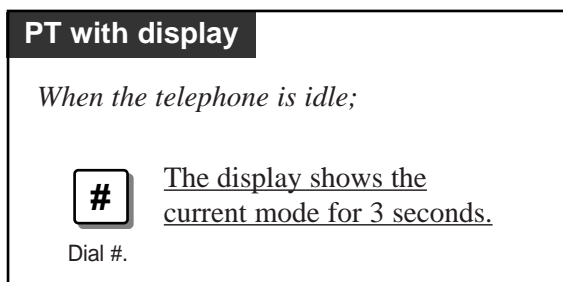

2.6 *Others*



- The following items have separate day and night programming:
 - 1) Outgoing Permitted ISDN Port Assignment
 - 2) Direct In Lines (DIL)
 - 3) Doorphone Ringing Assignment
 - 4) Intercept Routing
 - 5) Delayed Ringing
 - 6) Toll Restriction Level
 - 7) Toll Restriction for System Speed Dialling
- With the KX-T7235, KX-T7433 and KX-T7436, the manager can execute this feature with the display operation.



- Display Operation (Section 2.7)
 - System Feature List
- System Programming (Section 3.4)
 - [100] Day/Night Service Starting Time
- COS Programming (Section 3.8)
 - [509] Night Service Access



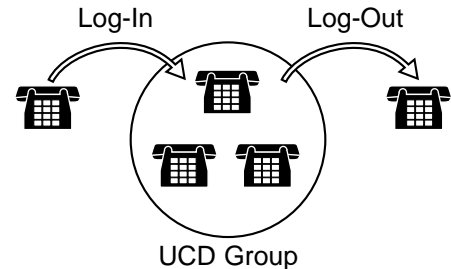

2.6 Others

Joining or Leaving a Call Distribution Group (Log-In / Log-Out)



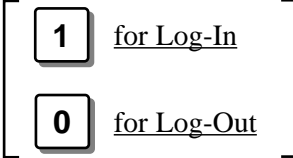

Allows you to assign your extension to join (log-in) or leave (log-out) a hunting or UCD group. Extensions in log-out status do not receive calls by Station Hunting but can receive other calls, unlike the DND feature. Default is the log-in mode.



SLT and PT

 Off-hook
  Dial 45.
  Dial 1 or 0.
  Confirmation tone
  On-hook

PT

 Off-hook
  Press Log-In/Log-Out.
  Confirmation tone
  On-hook

The indicator light turns off in Log-In mode or turns steady red in Log-Out mode.



- There should be at least one extension that is in log-in status.
- When the extension is in log-out status, dial tone 2 is sent when you lift the handset.
- The proprietary telephone user can assign the Log-In/Log-Out button at a flexible CO button.



- Initial Setting (Section 2.2)
Customising the Buttons on Your Telephone

2.6 Others

Setting the Paralleled SLT to Ring (Paralleled Telephone Connection)

A proprietary telephone (PT) can be connected in parallel with a standard single line telephone (SLT). This feature allows you to enable or disable SLT ringing. When a parallel connection is made, either telephone can be used.

To enable / disable SLT ringing

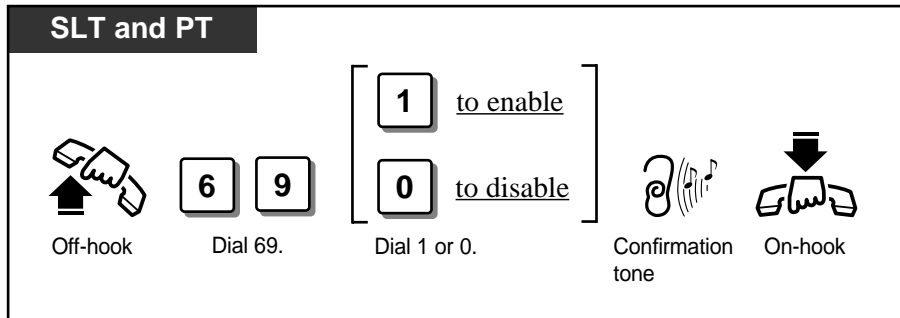

- Default is “Parallel Off (SLT ringing disabled).”
- The PT can be used to perform normal operations whether or not an SLT is enabled.
- When receiving a call:
 - If SLT ringing is enabled, then both the PT and the SLT ring except when the PT is in the “Handsfree Answerback” mode or Voice-Calling mode.
 - If SLT ringing is disabled, then the PT rings but the SLT does not. However the SLT can answer the call.
- When the SLT is in use, the display and the indicators of the PT will show in the same way as if the PT is in use.
- If you go off-hook while your paralleled telephone is in use, the call will switch over to your telephone, and vice versa. (PT only)
- The “XDP*” feature is available. Refer to System Management.
- With the KX-T7235, KX-T7433 and KX-T7436, you can execute this feature with the display operation.



- Display Operation (Section 2.7)
 - System Feature List
- System Management (Section 3.1)
 - EXtra Device Port (XDP)
- Connecting the Telephones in Parallel (Section 4.10)

* A XDP (eXtra Device Port) expands the number of telephones available in the system by allowing an extension port to contain two telephones.

2.6 Others

Caller Identification Services (for KX-T7230/KX-T7235/KX-T7433/KX-T7436)

Displaying the Caller's Information (Caller ID)

Provides you with the caller's telephone number and name if you have subscribed to the calling line identification service. You can record the caller's telephone number (and name if assigned) into the call log by pressing **LOG (S2)** button. The sample display is KX-T7230.

Viewing the display (Receiving)

While receiving an incoming outside call

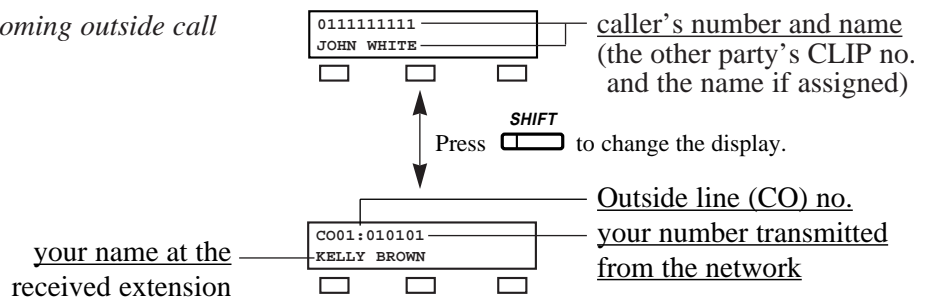

Off hook or press
SP-PHONE/MONITOR.

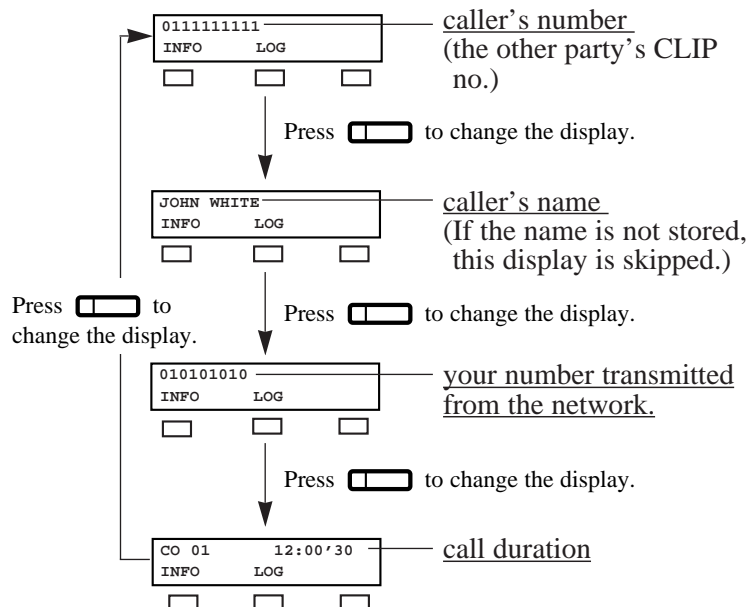

- To indicate the name on the display while receiving the call, the caller's name should be previously stored in the programming for the System Speed Dialling by PC. For further information, refer to "[001] System Speed Dialling Number Set" in 3.3 Manager Programming, and 3.13 PC Programming.
- You can use the **INFO (S1)** button to change the display instead of using the CO button.
- Press **SHIFT** button to change into the normal display after you go off-hook.

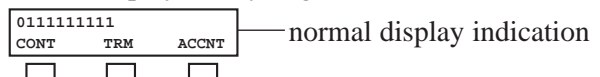

2.6 Others

Viewing the display (Dialling)

Off-hook or press SP-PHONE/MONITOR and dial an outside line access code + the phone number.

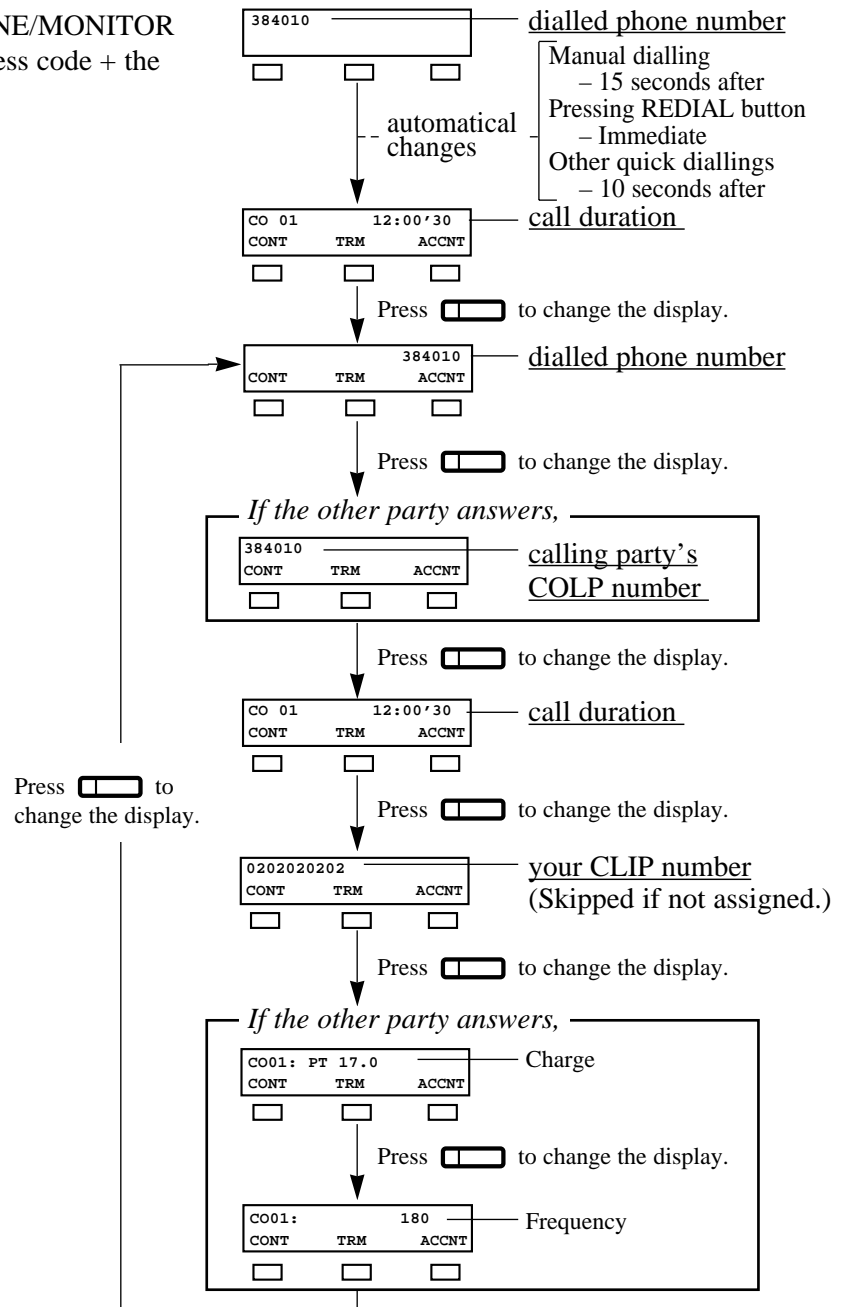

2.6 *Others*



- You can program whether the charge or the frequency comes first to be shown by the System Programming [107].
- If the other party doesn't answer, displays for the other party's COLP number and Charge Information are skipped.
- Your CLIP number is programmable by System Programming [404].
- Before the calling party answers, the calling party's COLP number and the charge information are not displayed.
- As soon as the charge information is received, the information is shown on the display and the display after this starts from the dialled phone number again. (See the above chart.)
- You can modify and call back the logged numbers. Refer to the "Recording the Caller's Information Automatically (Incoming Call Log)."



- Others (Section 2.6)
 - Recording the Caller's Information Automatically
(Incoming Call Log — KX-T7230/KX-T7235/KX-T7433/KX-T7436)
 - Locking the Incoming Call Information Display
(Incoming Call Log Lock — KX-T7230/KX-T7235/KX-T7433/KX-T7436)
- Manager Programming (Section 3.3)
 - [001] System Speed Dialling Number Set
- System Programming (Section 3.4)
 - [107] Charge Indication Selection
- ISDN Port Programming (Section 3.7)
 - [404] CLIP/COLP Number Assignment
- PC Programming (Section 3.13)

* An ISDN line with the Caller ID feature provides you with a caller's information, such as his/her telephone number, on the outside line (CO) assigned to receive ISDN service calls.

2.6 Others

Recording the Caller's Information Automatically (Incoming Call Log — KX-T7230/KX-T7235/KX-T7433/KX-T7436)

If you do not answer an incoming outside call or even if you answer the call, your extension automatically records the incoming outside call information from the Caller ID service*. The SHIFT button indicator lights and tells you that there are calls logged. Up to 15 calls can be logged per extension. When the call log is full (i.e. more than 15 calls), new call information is not logged. You can overwrite the data using the following feature, replacing the oldest call log with the newest one. You can also modify and call back the logged numbers.



- The SHIFT indicator light may turn on when receiving a call. Pressing this button provides you with more information about the caller.
- To clear the displayed information, press the CLR (S2) button.
- You can modify the displayed telephone number before dialling. Use “*” to erase and “0 to 9” to add numbers from the first digit.
- If you modify the displayed telephone number, the new number will be replaced.
- To return to the initial display, go off-hook and on-hook or press the MENU (S1) button.
- You can lock the display so that the recorded incoming outside call information is not shown on the display.



- Others (Section 2.6)
 - Locking the Incoming Call Information Display
(Incoming Call Log Lock — KX-T7230/KX-T7235/KX-T7433/KX-T7436)
- Manager Programming (Section 3.3)
 - [001] System Speed Dialling Number Set

* The Caller ID service provides you with the caller's information, such as his/her name and telephone number, on the outside line (CO) assigned to receive Caller ID service calls. Refer to System Programming.

Overwriting the call log

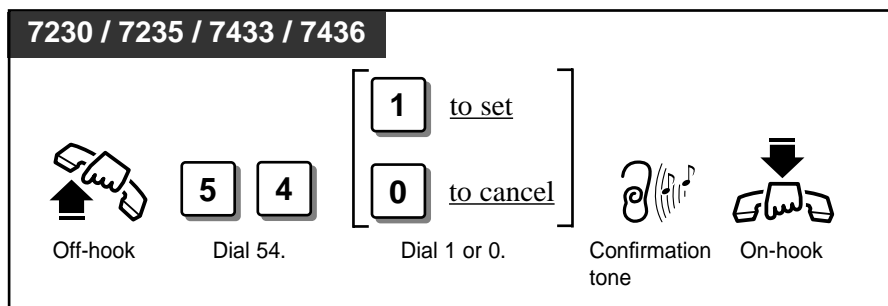

2.6 Others

Confirming and calling back

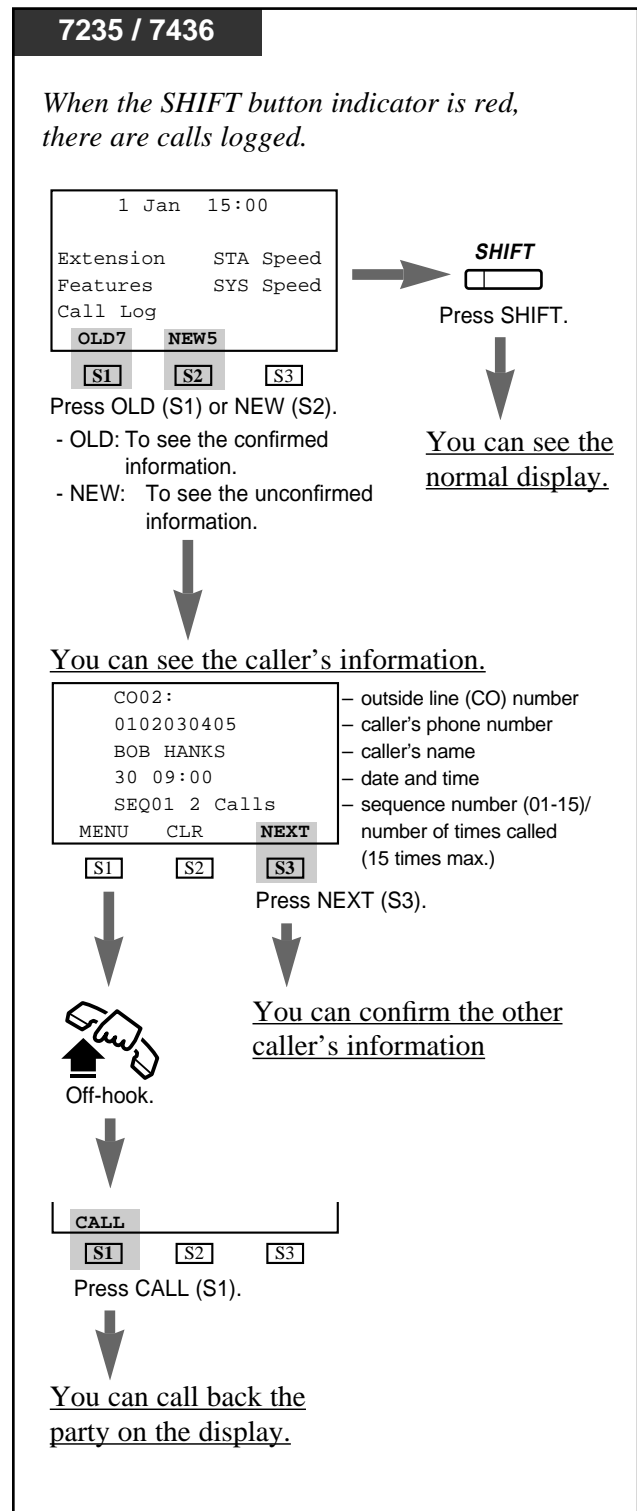
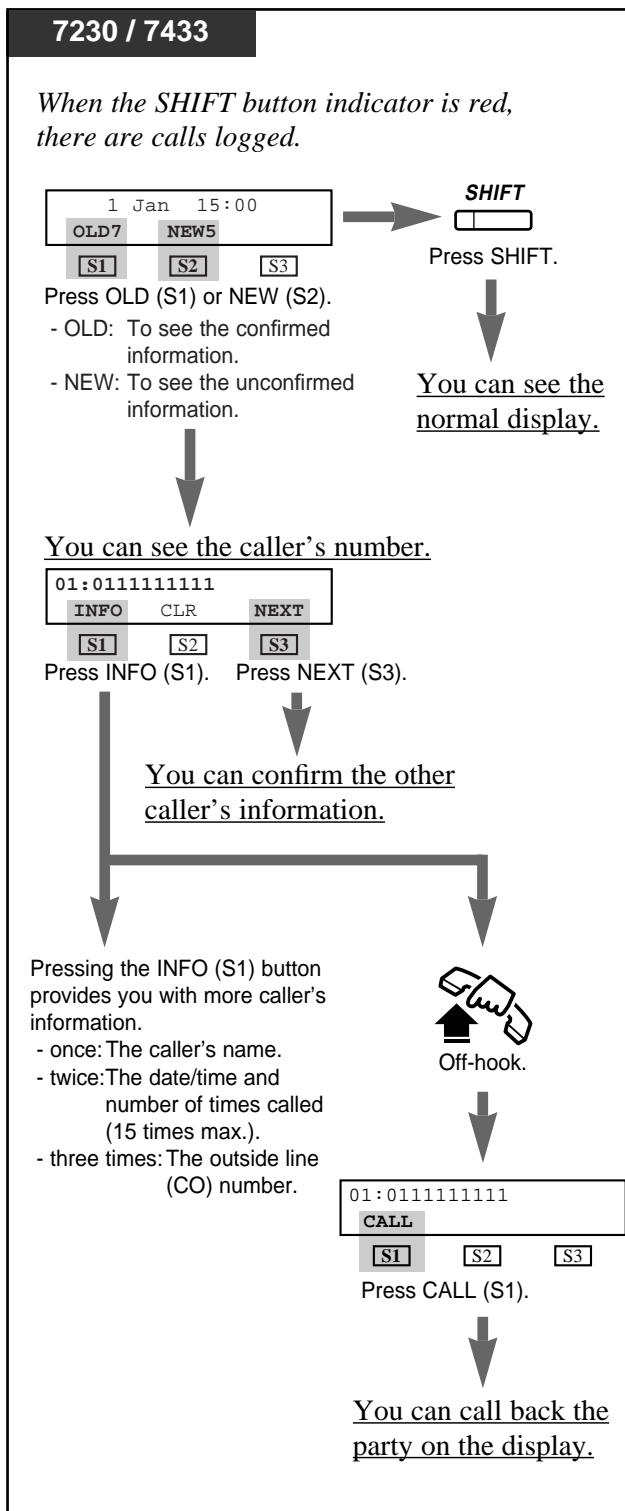

- If the first display indication is not the same as above, you must press the SHIFT button for changing the display.

2.6 Others

Locking the Incoming Call Information Display

(Incoming Call Log Lock — KX-T7230/KX-T7235/KX-T7433/KX-T7436)

Allows you to lock the display of your extension so that incoming outside call information is not shown on the display.

Locking

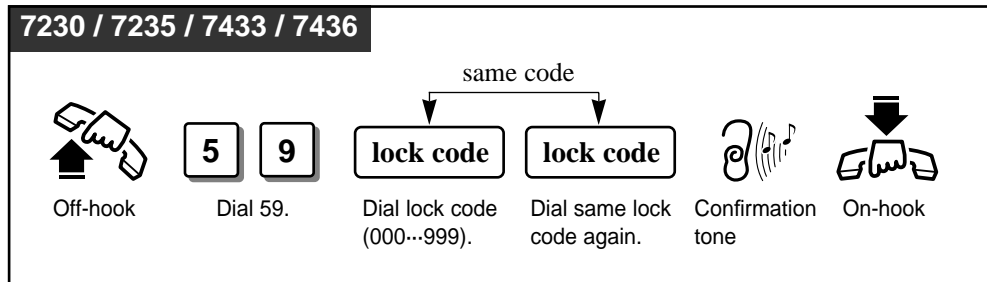

Unlocking

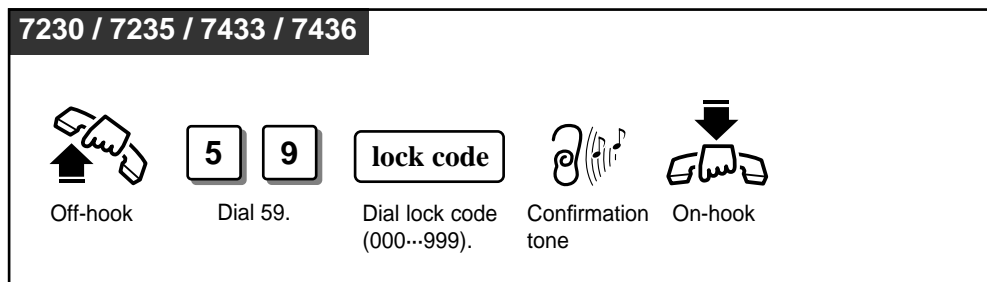

- The manager can unlock the call log display at any extension, if you forget your lock code.
- Once you have locked the extension with the lock code, you cannot release the lock with a different lock code.
- When you use a wrong lock code, you will hear a reorder tone.



- Others (Section 2.6)
 - Recording the Caller's Information Automatically
(Incoming Call Log — KX-T7230/KX-T7235/KX-T7433/KX-T7436)
- Manager Operations (Section 2.8)
 - Unlocking "Incoming Call Log Lock" (Incoming Call Log Lock Control)

2.6 Others

Canceling the Feature Setting (Station Feature Clear)

Allows you to reset the following station features to the default settings.

- a) Absent Message Capability
- b) Automatic Callback Busy (Camp-On)
- c) Background Music (BGM)
- d) Call Forwarding
- e) Incoming Call Log – (Overwriting the data will be cancelled)
- f) Call Pickup Deny
- g) Call Waiting
- h) Calling Line Identification Restriction (CLIR)
- i) Connected Line Identification Restriction (COLR)
- j) Do Not Disturb (DND)
- k) Executive Busy Override Deny
- l) Log-In mode
- m) Message Waiting – (All messages will be removed)
- n) Paging – Deny
- o) Paralleled Telephone Connection
- p) Pickup Dialling – (The stored telephone number will be removed)
- q) Timed Reminder

Clearing the current feature setting

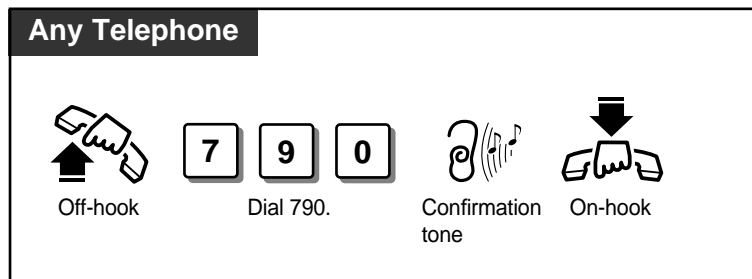

2.6 Others

ISDN Network Service Access

Allows you to access a service which is provided from ISDN.

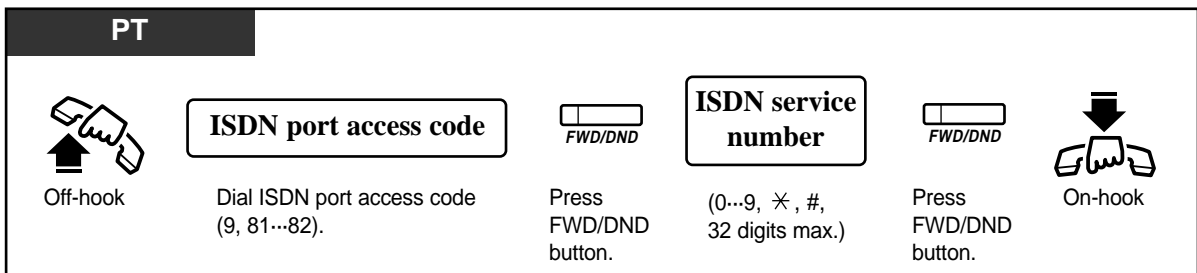
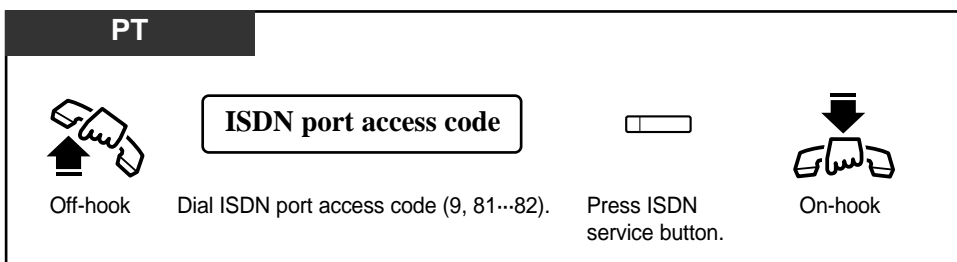
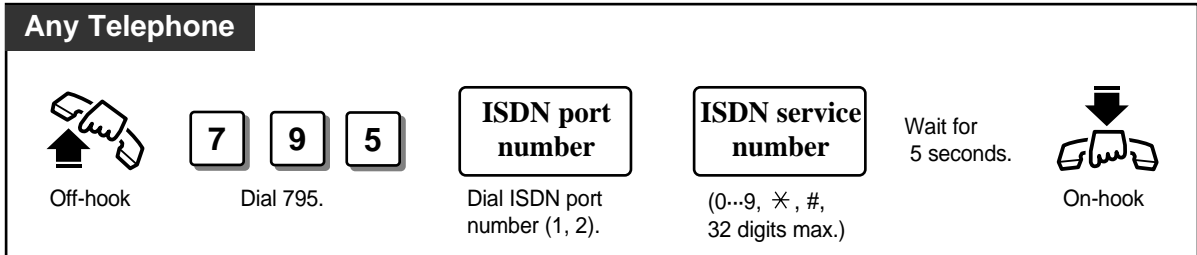

- To use the ISDN service button on a proprietary telephone, you must assign a flexible button as the ISDN service button first.
- You can press the CO button instead of entering an ISDN port access code.
- You can receive a confirmation message from ISDN if the network offers such services.
- You can use the ISDN service button after pressing a outside line (CO) access code or a CO button. You will hear a reorder tone if a wrong operation is done.
- The availability of this feature depends on your local ISDN services.



- Initial Settings (Section 2.2)
Customising the Buttons on Your Telephone

2.6 Others

Selecting the CLIP / COLP numbers

You can select the CLIP / COLP numbers to be displayed to the other party depending on business or private use.

Setting the CLIP numbers

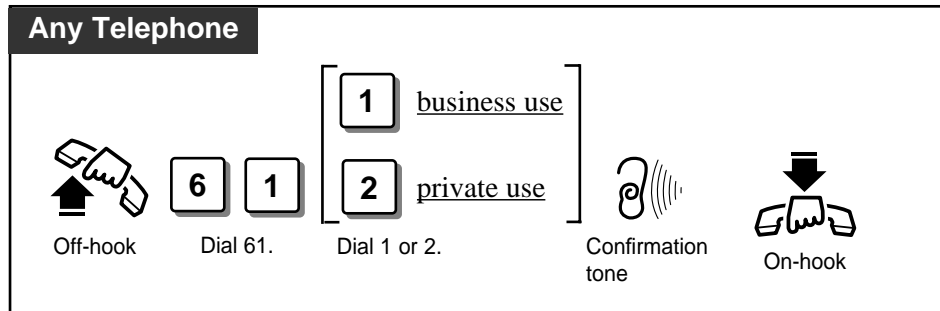

Setting the COLP numbers

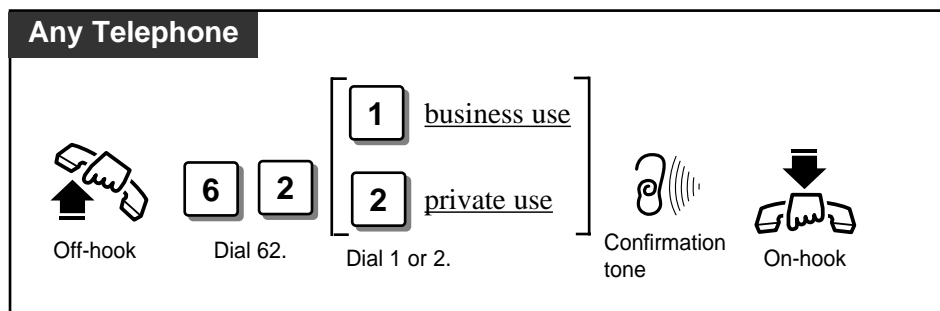

- Your CLIP number will be displayed if the number is assigned by the System Programming [404].
- Caller Identification (Caller ID) services can be denied depending on your COS level.
- If you select the same setting previously selected, a confirmation tone 2 and dial tone will be sent.



- ISDN Port Programming (Section 3.7)
[404] CLIP/COLP Number Assignment
- COS Programming (Section 3.8)
[512] Calling Line Identification Restriction (CLIR)
[513] Connected Line Identification Restriction (COLR)
- Extension Programming (Section 3.9)
[601] Class of Service

2.7 *Display Operation (KX-T7235/KX-T7433/KX-T7436)*

Panasonic digital proprietary telephones with a display, KX-T7235, KX-T7433 and KX-T7436, allow you to make a call or operate the features using the display message. The display prompts you with information related to the desired feature.

Features in the Idle Status

While idle, you can change the display by pressing the MODE or SHIFT button. Each model has a different operation (☞ See the next page). Available features are listed below.

- Extension (Extension Dialling)
 - STA Speed, Station Speed (Station Speed Dialling)
 - SYS Speed, System Speed (System Speed Dialling)
 - Features (System Feature Access) (☞ See page 2-83.)
- Call Log (Outgoing Call Log — Dialling the last five outgoing calls)
(KX-T7235/KX-T7436 only)

Station Speed Dialling Number/Name Assignment

FWD/DND* Features (KX-T7235/KX-T7436 only)

By pressing the FWD/DND button after going off-hook, a new display appears. From this display, the following additional System Features can be operated.

- FWD/DND Cancel (Cancelling “FWD/DND”)
 - Do Not Disturb (Rejecting incoming calls)
 - FWD-All Calls, FWD-Busy, FWD-No Answer (Forwarding a call)
- FWD-Busy/NA, FWD-CO Line (Forwarding a call)
 - FWD-From, FWD-From Cancel (Forwarding all calls remotely)

* FWD/DND — FWD stands for Forwarding and means forwarding a call.
DND stands for Do Not Disturb and means rejecting a call.

Incoming Call Log (☞ See page 2-71.)

2.7 Display Operation (KX-T7235/KX-T7433/KX-T7436)

Display View of the Features in the Idle Status

– KX-T7433

While idle, the bottom line of the display changes by pressing the SHIFT button as follows. The Jog Dial operation is available in the third display.

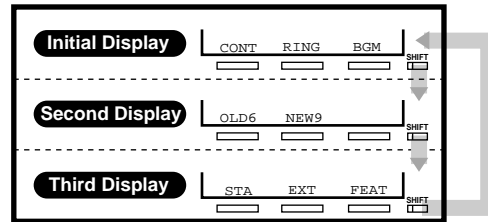

– KX-T7235 and KX-T7436

To use the Soft buttons, use the bottom line in the third display which appears by pressing the SHIFT button as follows. The Jog Dial operation of the KX-T7436 is available after pressing a Function button on third and fourth line.

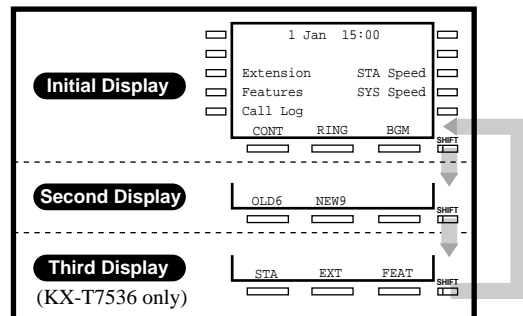

- The second display of the KX-T7235, KX-T7433 and KX-T7436 (KX-T7230 is also available.) is used to call back the caller by checking the call log data (Incoming Call Log). For operation, refer to page 2-72.

Jog Dial Operation for KX-T7400 series

You can search for desired items by using the Jog Dial on the corresponding display menu. Rotate the Jog Dial in either direction as desired. The items will be displayed as follows.

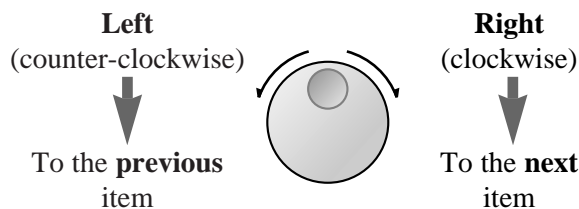

2.7 Display Operation (KX-T7235/KX-T7433/KX-T7436)

Display Operation for the Features in the Idle Status

Extension
Dialling

Station Speed
Dialling

System Feature
Access

System Speed
Dialling

— KX-T7235

Using the Function button

You should press the desired button which is corresponding to the display message. The display changes step by step. The example operations are shown below.

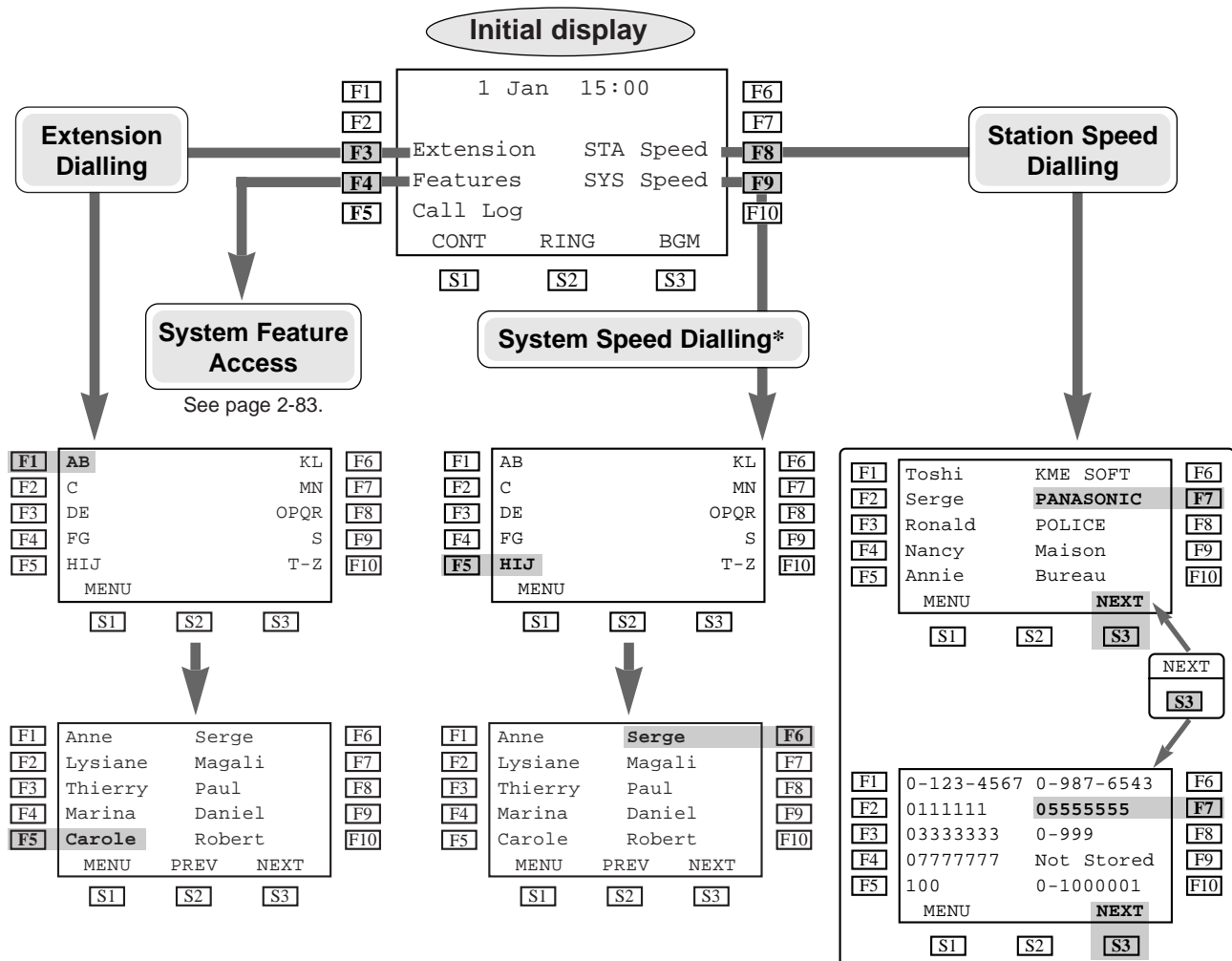

- *"SYS Speed" is available only when the System Speed Dial name is assigned by your personal computer (PC).
- Storing extension numbers and names is available only by PC programming.

2.7 Display Operation (KX-T7235/KX-T7433/KX-T7436)

— KX-T7433

1 Press the **SHIFT** button repeatedly to set the display to the third display.

2 Select the desired feature.

- Press the **STA** (S1) button (for Station Speed Dialling).
- Press the **EXT** (S2) button (for Extension Dialling).
- Press the **FEAT** (S3) button (for System Feature Access).
- Rotate the Jog Dial (for System Speed Dialling).

3 Rotate the **Jog Dial** until the desired item is at the arrow on the display.

- 4
- Press the **CALL** (S3) button (for System Speed Dialling, Station Speed Dialling and Extension Dialling).^{*2}
 - Press the **SEL** (S3) button (for System Feature Access).

5 Enter a parameter if required, or follow the procedure for standard operation (for System Feature Access only).

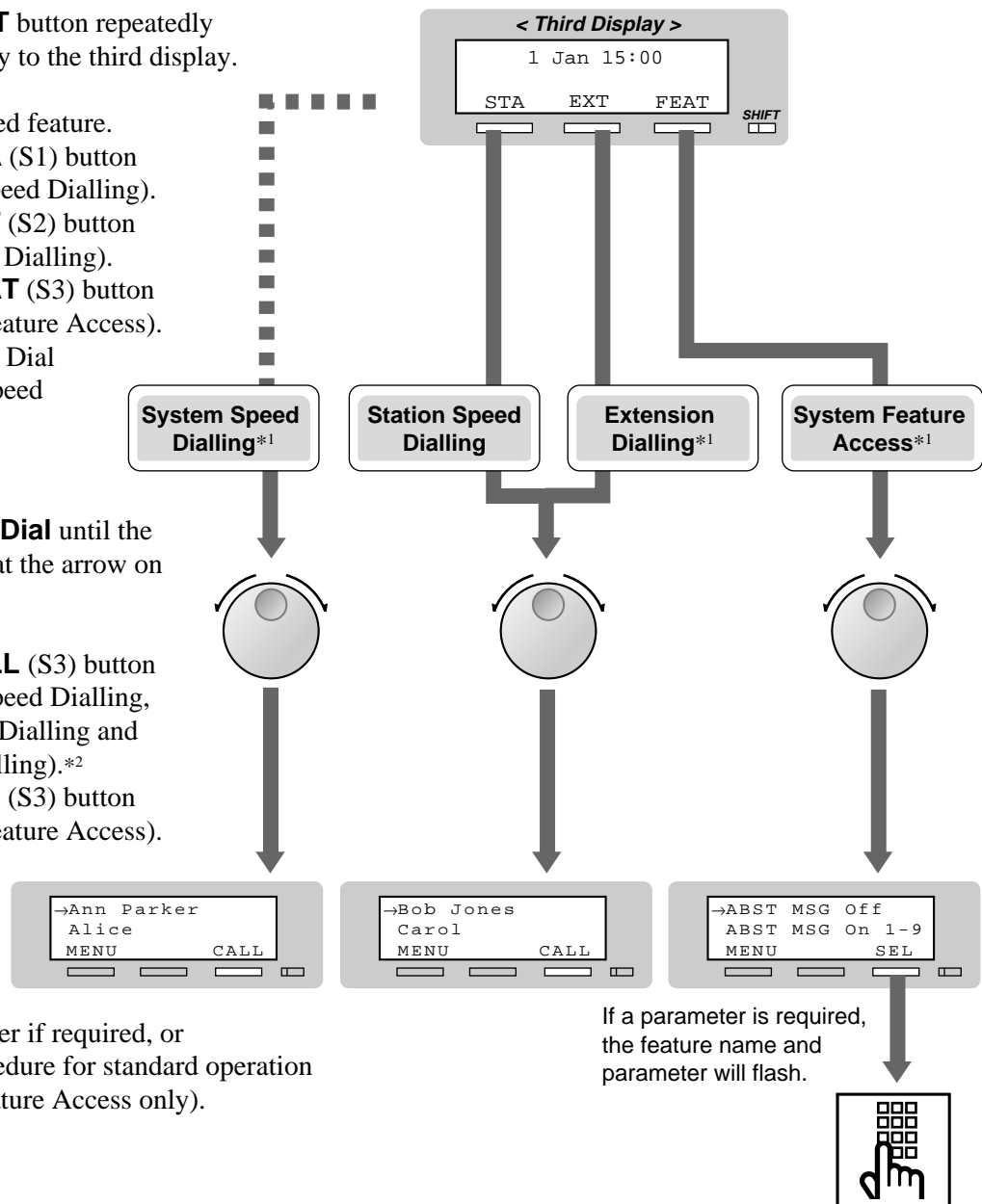

*1 For System Speed Dialling, Extension Dialling and System Feature Access, before rotating the Jog Dial, you can press the corresponding key search for the desired letter.

<Example> Press 2 two times to display "B" items.

*2 You can lift the handset or press the SP-PHONE button instead of the CALL (S3) button.

2.7 Display Operation (KX-T7235/KX-T7433/KX-T7436)

— KX-T7436

Using the Function button

- 1 Select the desired feature.
 - Press the **F3** button (for Extension Dialling).
 - Press the **F4** button (for System Feature Access).^{*3}
 - Press the **F5** button (for dialling using the call log).
 - Press the **F8** button (for Station Speed Dialling).
 - Press the **F9** button (for System Speed Dialling).

- 2 Rotate the **Jog Dial** until the desired item is at the arrow on the display.

- 3 • Press the **CALL** (S3) button (for System Speed Dialling, Station Speed Dialling and Extension Dialling).^{*4}
- Press the **SEL** (S3) button (for System Feature Access). Or press the corresponding buttons on the side of the display. (Function button).^{*5}

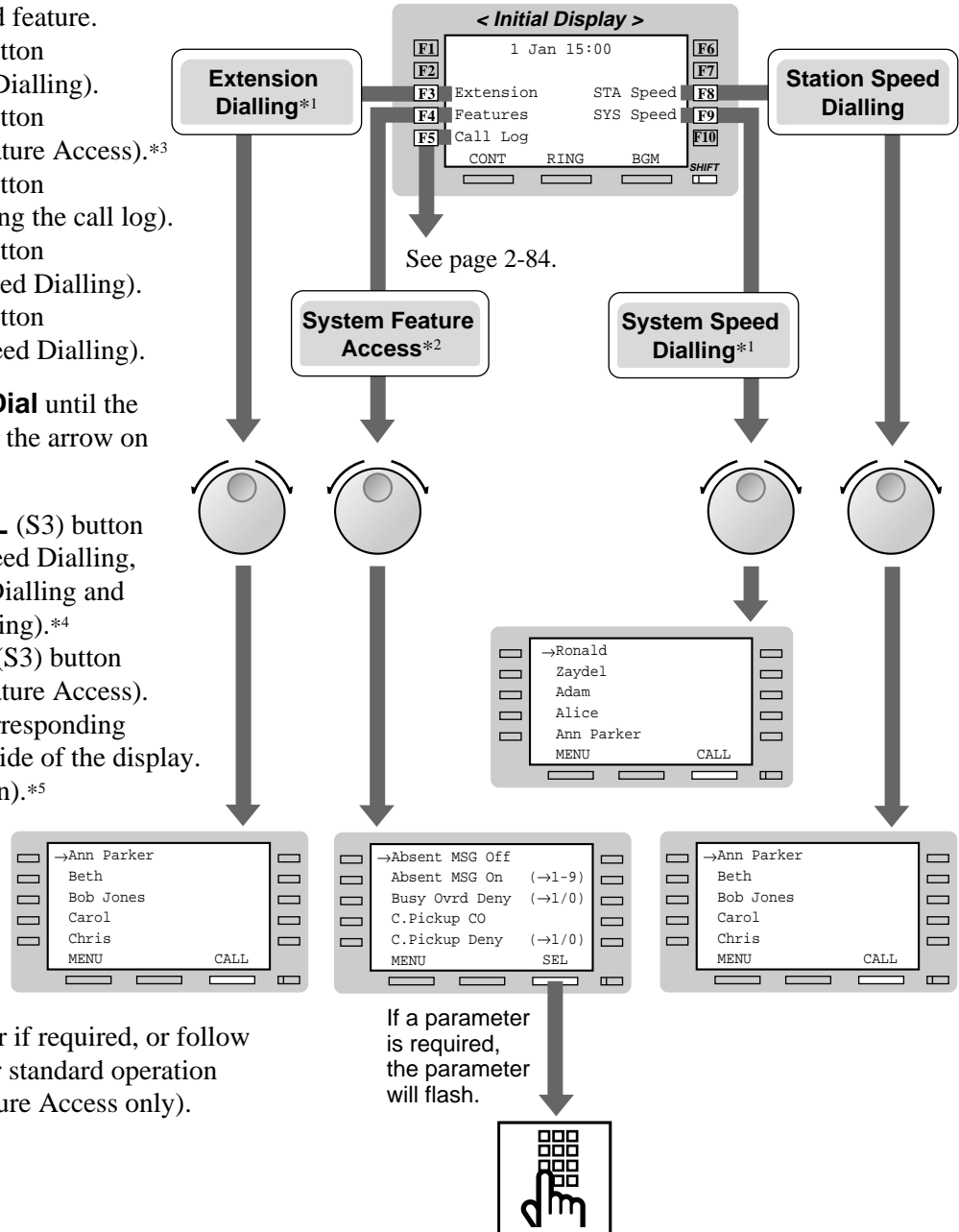

- 4 Enter a parameter if required, or follow the procedure for standard operation (for System Feature Access only).

^{*1} For System Speed Dialling, Extension Dialling and System Feature Access, before rotating the Jog Dial, you can press the corresponding key search for the desired letter.

<Example> Press 2 two times to display "B" items.

^{*2} For System Feature List, see page 2-83.

^{*3} You can press the Function (F4) button in any display (initial through third).

^{*4} You can lift the handset or press the SP-PHONE button instead of the CALL (S3) button.

^{*5} You can press the Function button (F1 through F5) on the same line of the desired item instead of the SEL (S3) button.

2.7 Display Operation (KX-T7235/KX-T7433/KX-T7436)

Using the Soft button or rotating the Jog Dial directly

1 Press the **SHIFT** button repeatedly to set the display to the third display.

2 Select the desired feature.

- Press the **STA** (S1) button (for Station Speed Dialling).
- Press the **EXT** (S2) button (for Extension Dialling).
- Press the **FEAT** (S3) button (for System Feature Access).
- Rotate the **Jog Dial** (for System Speed Dialling).

3 Rotate the **Jog Dial** until the desired item is at the arrow on the display.

- 4
- Press the **CALL** (S3) button (for System Speed Dialling, Station Speed Dialling and Extension Dialling).^{*3}
 - Press the **SEL** (S3) button (for System Feature Access). Or press the corresponding buttons on the side of the display. (Function button).^{*4}

5 Enter a parameter if required, or follow the procedure for standard operation (for System Feature Access only).

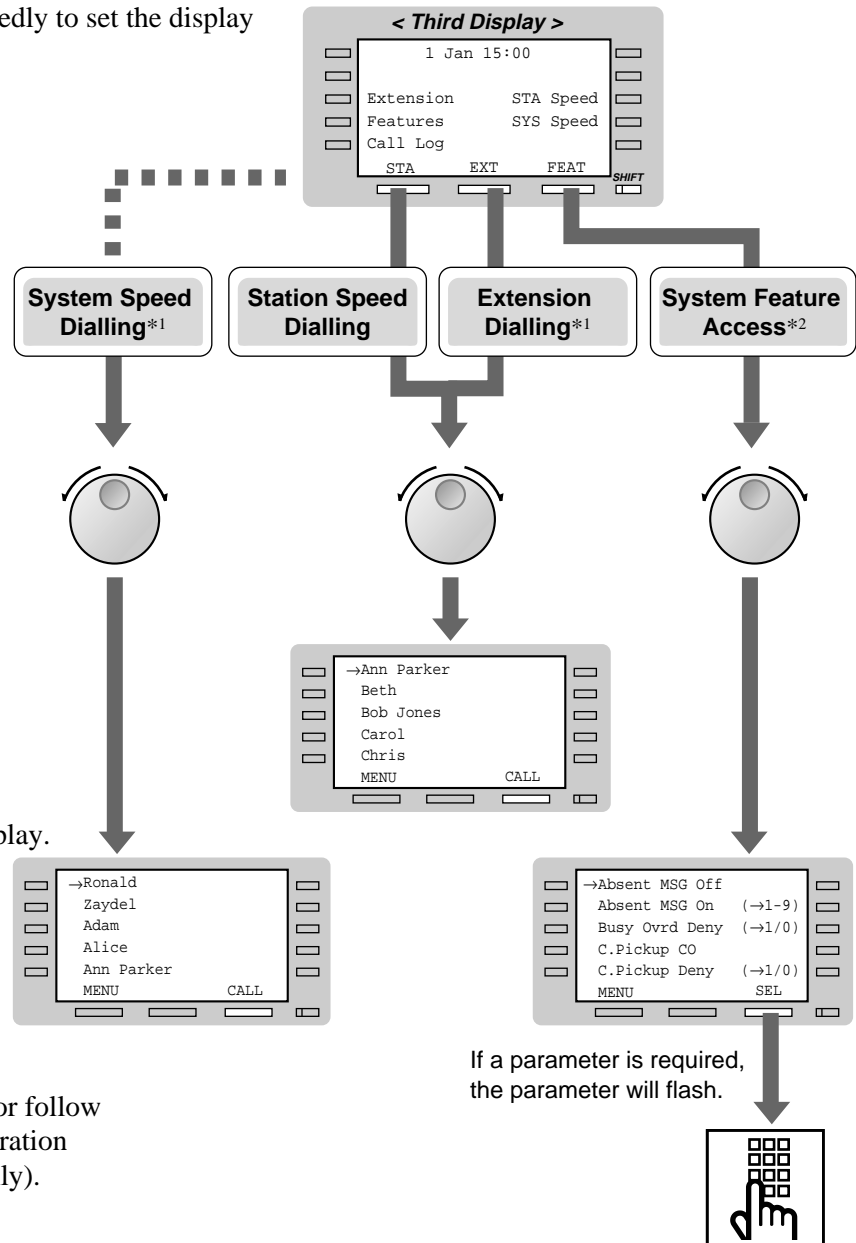

^{*1} For System Speed Dialling, Extension Dialling and System Feature Access, before rotating the Jog Dial, you can press the corresponding key search for the desired letter.

<Example> Press 2 two times to display "B" items.

^{*2} For System Feature List, see page 2-83.

^{*3} You can lift the handset or press the SP-PHONE button instead of the CALL (S3) button.

^{*4} You can press the Function button (F1 through F5) on the same line of the desired item instead of the SEL (S3) button.

2.7 Display Operation (KX-T7235/KX-T7433/KX-T7436)

System Feature List

You can access the following features which are displayed in alphabetical order.
The parameters used in the list are for a telephone connected to a KX-TD208.

| DISPLAY (KX-T7235/KX-T7436) | DISPLAY (KX-T7433) | FEATURE DESCRIPTION |
|--------------------------------|-----------------------|--|
| Absent MSG Off | ABST MSG Off | Cancel the absent message. |
| Absent MSG On (→1-9) | ABST MSG On 1-9 | Set an absent message. |
| Busy OvrD Deny (→1/0) | BSY Ovr DNY 1/0 | Prevent others from interrupting your conversation on the line. |
| C.Pickup CO | C.Pickup CO | Pick up a call from an exchange line. |
| C.Pickup Deny (→1/0) | C.PickupDNY 1/0 | Stopping your calls from being picked up. |
| C.Pickup Direct (→ext) | C.PickupDRT ext | Pick up a call from a specific extension. |
| C.Pickup Group | C.Pickup GRP | Pick up a call ringing at another telephone within your group. |
| C.Waiting (→1/0) | C.Waiting 1/0 | Informs you that there is a call waiting using a tone. |
| Call Park (→0-9) | Call Park 0-9 | Place a call on hold in a system parking area. |
| Callback Busy Cancel | Callback Cancel | Cancel the Automatic Callback Busy. |
| Door Open | Door Open | Open the door. |
| Doorphone Call | Doorphone | Call the doorphone. |
| Log Lock Call (→abcabc) | Log Lock abcabc | Prevent others from accessing your call log. |
| Log Overt On/Off (→1/0) | Log Overt 1/0 | Overwrite or delete your call log. |
| Login/Logout (→1/0) | Login/out 1/0 | Join or leave the hunt group. |
| Message Off (→ext) | MSG Off ext | Cancel a notification. |
| Message On (→ext) | MSG On ext | Leave a notification so that the called party may call you back. |
| Night Auto/On/Off (→0-2) | Night Mode 0-2 | Change the day / night mode.* |
| Page Deny On/Off (→1/0) | Page Deny 1/0 | Stopping reception of paging announcements. |
| Page-GRP Answer | Page-GRP ANS | Answer the page through a telephone in the same extension group. |
| Paging Group (→0-8) | Page GRP 0-8 | Page to all or a particular extension group. |
| Parallel On/Off (→1/0) | Parallel 1/0 | Set whether a single line telephone connected in parallel will ring not when receiving a call. |
| Pickup Dialing (→1/0) | Pickup Dial 1/0 | Make a call without dialling. |
| Pickup DL Prg (→..#) | Pickup DL PG ..# | Assign the number for the Pickup Dialling. |
| Station Lock (→abcabc) | St.Lock abcabc | Prevent others from calling from your extension. |
| Station Program Clear | STA Prog Clear | Cancel the station programmed data. |
| Timed Reminder | Timed Reminder | Set an alarm call. |

For more details about the features and the required parameters, refer to the respective features in this manual.

Only the Operator can carry out the feature marked with “*”.

2.7 Display Operation (KX-T7235/KX-T7433/KX-T7436)

Outgoing Call Log

— KX-T7235 and KX-T7436

Dialling the last five outgoing calls (Outgoing Call Log)

- 1 Press the **SHIFT** button to set the display to the second display.

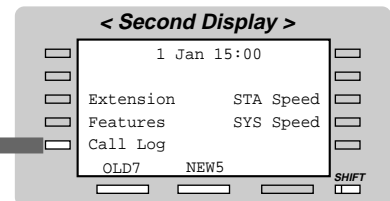

Outgoing Call Log
To make a call using the call log
(last five outside calls you dialed).

- 2 Press the corresponding button on the side of the display (for the outgoing call log).

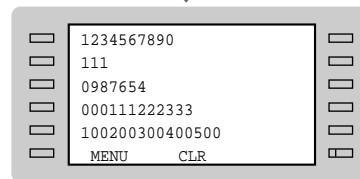

2.7 Display Operation (KX-T7235/KX-T7433/KX-T7436)

Station Speed Dialling Number/Name Assignment

1 Press the **PROGRAM** button and dial **99** to enter into the programming mode.

2 For KX-T7433:
Dial * * and the desired station speed dial number.
For KX-T7235 and KX-T7436:
Press the desired Function button.

3 Storing a number
Dial the desired number.
(16 digits max.).
Storing a name
Press the **NEXT** (S3) button and enter the name* (10 digits max.).

4 Press the **STORE** button.

5 Press the **PROGRAM** button to exit the programming mode.

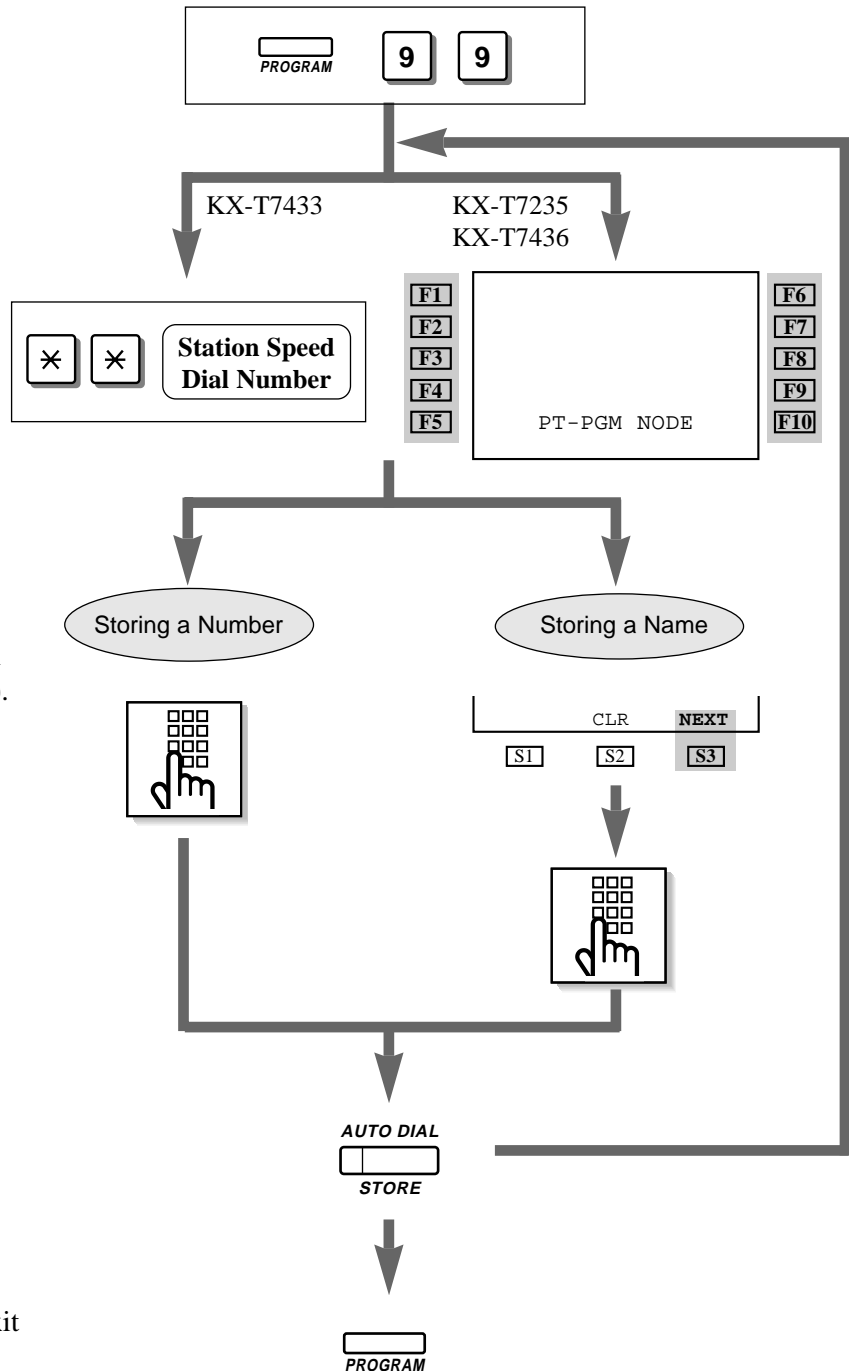

*: See the Combination Table on page 2-87.

2.7 *Display Operation (KX-T7235/KX-T7433/KX-T7436)*



- To store numbers, you can use 0 through 9, *, #, PAUSE, RECALL, CONFERENCE and the INTERCOM button as follows:

RECALL: registers the recall signal

PAUSE or * *: pause

CONFERENCE : - (hyphen) after the outside line (CO) access code

INTERCOM : [or] (secret code) – Press the INTERCOM button before and after the part you wish to conceal when it is shown on the display when dialling.

Combination Table

Each character can be entered by using the dial key pad and some buttons, or the Jog Dial for storing names.

Combination Table 1 shows the combination of keys and the number of times to press the SELECT (AUTO ANSWER/MUTE) button, or the combination of keys and the SHIFT and Soft buttons to enter characters. (The AUTO ANSWER/MUTE button becomes the SELECT button when using the overlay.)

To enter a character, find the key and number of times to press the SELECT button or the corresponding SHIFT and Soft button combination on the table. Press the corresponding key first, then press the SELECT button the required number of times. Or you can use the SHIFT button and the Soft button (S1 through S3) instead of the SELECT button.

Combination Table 2 shows the combination of keys and the number of pulses to move the Jog Dial (click tones) to the right.

To enter a character, find the key and number pulses to rotate the Jog Dial. Press the corresponding key first, then rotate the Jog Dial the required number of times. Or, if you keep rotating the Jog Dial after pressing any dialling key, all of the characters in the table will be displayed.

2.7 Display Operation (KX-T7235/KX-T7433/KX-T7436)

Combination Table 1

| SHIFT & Soft Combination | | S1 | SHIFT+ S1 | S2 | SHIFT+ S2 | S3 | SHIFT+ S3 | SHIFT+ SHIFT+ S1 | SHIFT+ SHIFT+ S2 |
|--------------------------|---|----|-----------|----|-----------|----|-----------|------------------|------------------|
| Pressing SELECT (Times) | | | | | | | | | |
| Keys | 0 | 1 | 2 | 3 | 4 | 5 | 6 | 7 | 8 |
| 1 | 1 | Q | q | Z | z | ! | ? | | |
| 2 | 2 | A | a | B | b | C | c | | |
| 3 | 3 | D | d | E | e | F | f | | |
| 4 | 4 | G | g | H | h | I | i | | |
| 5 | 5 | J | j | K | k | L | l | | |
| 6 | 6 | M | m | N | n | O | o | | |
| 7 | 7 | P | p | Q | q | R | r | S | s |
| 8 | 8 | T | t | U | u | V | v | | |
| 9 | 9 | W | w | X | x | Y | y | Z | z |
| 0 | 0 | | . | , | ' | : | ; | | |
| * | * | / | + | - | = | < | > | | |
| # | # | \$ | % | & | @ | (|) | | |

Combination Table 2

| Rotating Jog Dial (Pulses) | | | | | | | | | |
|----------------------------|---|----|---|---|---|---|---|---|----|
| Keys | 0 | 1 | 2 | 3 | 4 | 5 | 6 | 7 | 8 |
| 1 | 1 | Q | q | R | r | S | s | T | t |
| 2 | 2 | A | a | B | b | C | c | D | d |
| 3 | 3 | D | d | E | e | F | f | G | g |
| 4 | 4 | G | g | H | h | I | i | J | j |
| 5 | 5 | J | j | K | k | L | l | M | m |
| 6 | 6 | M | m | N | n | O | o | P | p |
| 7 | 7 | P | p | Q | q | R | r | S | s |
| 8 | 8 | T | t | U | u | V | v | W | w |
| 9 | 9 | W | w | X | x | Y | y | Z | z |
| 0 | 0 | | ! | ? | . | , | ' | : | ; |
| * | * | / | + | - | = | < | > | # | \$ |
| # | # | \$ | % | & | @ | (|) | A | a |

2.7 *Display Operation (KX-T7235/KX-T7433/KX-T7436)*

<Example>

— To enter “Mike” by using the SELECT button;

See Combination Table 1.

1. Press 6 and then press the SELECT button once to enter “M.”
2. Press 4 and then press the SELECT button six times to enter “i.”
3. Press 5 and then press the SELECT button four times to enter “k.”
4. Press 3 and then press the SELECT button four times to enter “e.”

— To enter “Mike” by using the SHIFT button and the Soft button;

See Combination Table 1.

1. Press 6 and then press the S1 button to enter “M.”
2. Press 4 and then press the SHIFT and S3 button to enter “i.”
3. Press 5 and then press the SHIFT and S2 button to enter “k.”
4. Press 3 and then press the SHIFT and S2 button to enter “e.”

— Using the Jog Dial (*With a KX-T7433/KX-T7436*)

See Combination Table 2.

1. Press 6 and then rotate the Jog Dial *one* pulse to enter “M”.
2. Press 4 and then rotate the Jog Dial *six* pulses to enter “i”.
3. Press 5 and then rotate the Jog Dial *four* pulses to enter “k”.
4. Press 3 and then rotate the Jog Dial *four* pulses to enter “e”.

OR

1. Press 2 and then rotate the Jog Dial until “M” appears.
2. Press 2 and then rotate the Jog Dial until “i” appears.
3. Press 2 and then rotate the Jog Dial until “k” appears.
4. Press 2 and then rotate the Jog Dial until “e” appears.



- Pressing the SHIFT button alternates between capital and lower case letters. Once this button is pressed, the SHIFT mode continues until it is pressed again.
- To erase the last word (to backspace), press the CONFERENCE button. (The CONFERENCE button becomes the “←” (backspace) key when using the overlay.)
- To erase all of the data, press the CLR (S2) button.
- If you keep rotating the Jog Dial, all of the characters will be displayed in order.
<Example> If you rotate the Jog Dial after pressing 2, all of the characters will appear in the following order:
A a B b ... Z z (space) ! ? . , ' : ; * / + - = < > # \$ % & @ () A a B b ...
- The default is “Not Stored.”
- Up to ten dialling numbers and names can be assigned. Each dialling number has a maximum of 16 digits and each name has a maximum of ten characters.

2.7 Display Operation (KX-T7235/KX-T7433/KX-T7436)

Display Operation for FWD/DND Features (KX-T7235/KX-T7436 only)

After pressing the desired button which corresponds to the message on the display, you can set or cancel the feature with ease. The example operations are shown below.

1 Off-hook.



2 Press the **FWD/DND** button.



3 Press the Function button (F1–F5) which is corresponding to the desired function.

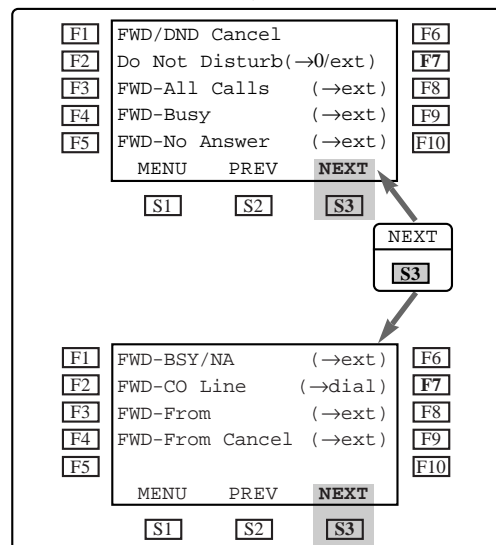

4 Enter parameters if required.

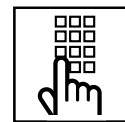

5 On-hook.

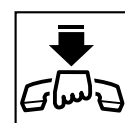

2.8 *Manager Operations*

Switching the Extension's "Class of Service" (Class of Service Switch)

Each extension is assigned a primary and secondary COS numbers. The manager can switch the extension's COS between a primary and secondary number.

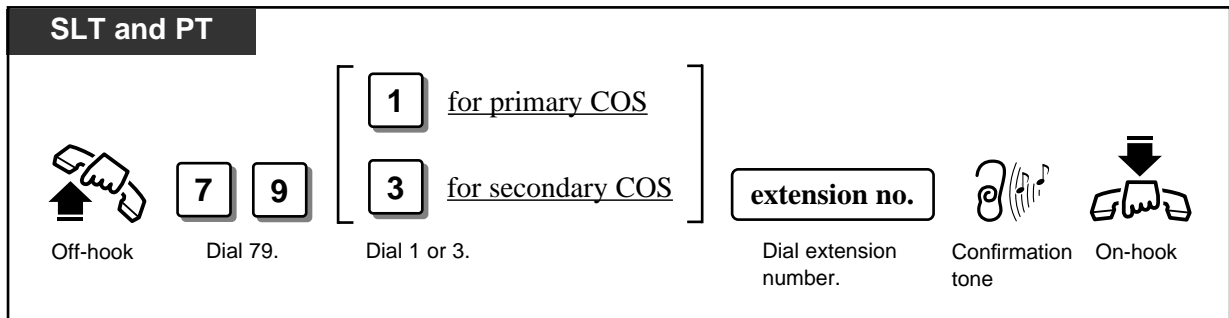

- With the KX-T7235, KX-T7433 and KX-T7436, the manager can execute this feature with the display operation.



- Display Operation (Section 2.7)
Display Operation for the System Feature Access Menu — COS Primary/Secondary
- System Management (Section 3.1)
Class of Service

Unlocking "Incoming Call Log Lock" (Incoming Call Log Lock Control)

The manager can clear the "Incoming Call Log Lock" feature at any extension.

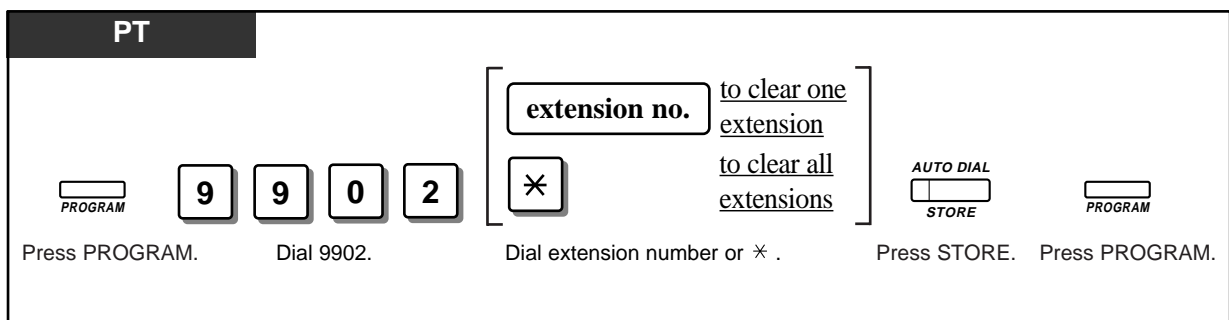

- If your proprietary telephone has no **PROGRAM** button, use the PAUSE button instead.



- Others (Section 2.6)
Recording the Caller's Information Automatically
(Incoming Call Log — KX-T7230/KX-T7235/KX-T7433/KX-T7436)

2.8 *Manager Operations*

Controlling “Electronic Station Lockout” Remotely (Remote Station Lock Control)

The manager is given the privilege of controlling Electronic Station Lockout at any extension. If Station Lockout has already been set by the extension user and Remote Station Lock is set by the manager, cancelling the lock is only possible by the manager.

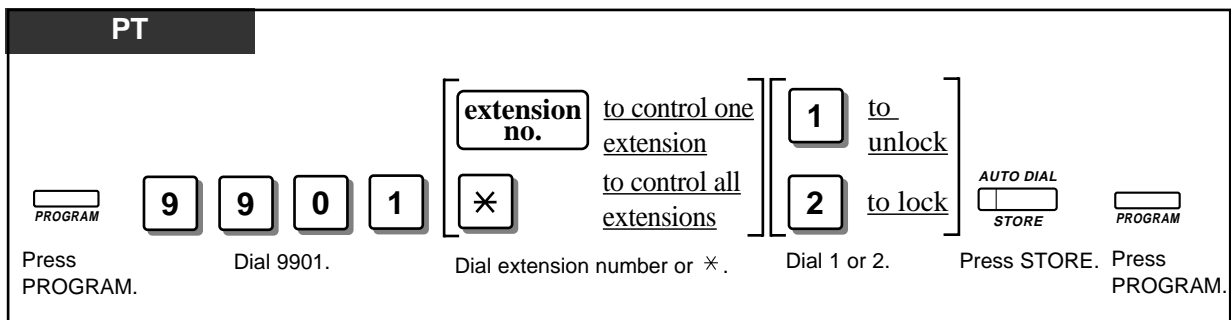
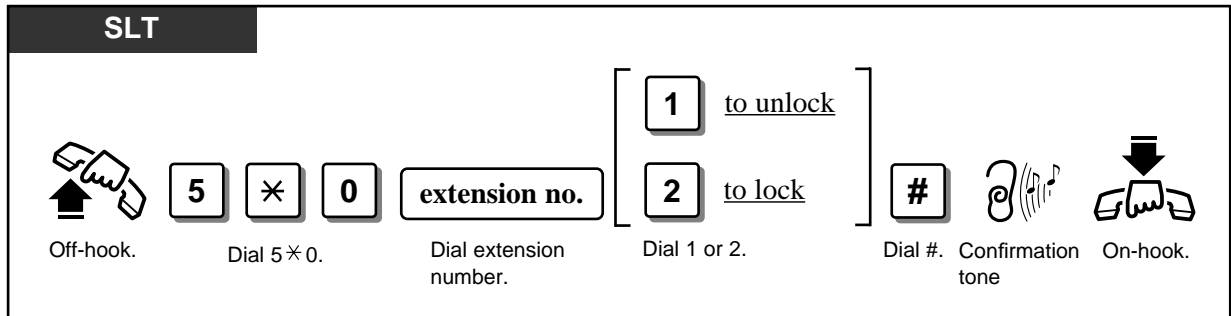

- If your proprietary telephone has no PROGRAM button, use the PAUSE button instead.



- Others (Section 2.6)
Locking Your Phone (Electronic Station Lockout)

Section 3

System Programming

<Note>

Description of Symbol Used

| SLT | ISDN-T | PT |
|-----|--------|----|
| ✓ | ✓ | ✓ |

“✓” indicates that the feature in this square is applicable to the single line telephone (SLT), ISDN telephone (ISDN-T) and proprietary telephone (PT).

3.1 System Management

| | | | |
|--|-----|--------|----|
| Accessing to Other types of network connected to the ISDN network | SLT | ISDN-T | PT |
| | ✓ | ✓ | ✓ |

To access other types of network from the ISDN network, sending out DTMF may be needed. To send out the dialled number in DTMF, you must insert a PAUSE (“* *”). Any digits following the PAUSE will be sent as DTMF.

Some examples of services requiring DTMF – Alternative carriers using analogue networks, Electronic banking



- This feature does not work when manually dialling.
- It is necessary to store a PAUSE in either the ARS Carrier Code or Authorization Code.



- Making Calls (Section 2.3)
 - Quick Dialling
 - Redialling
- System Management (Section 3.1)
 - Automatic Route Selection (ARS)
- Manager Programming (Section 3.3)
 - [001] System Speed Dialling Number Set
- Timer Programming (Section 3.5)
 - [205] DTMF Sending PAUSE Time
- ARS Programming (Section 3.10)
 - [701] ARS Carrier Code
 - [703] ARS Authorization Code
 - [704] ARS Itemized Bill Code

3.1 System Management

| | | | |
|--|-----|--------|----|
| Automatic Route Selection (ARS) | SLT | ISDN-T | PT |
| | ✓ | ✓ | ✓ |

Automatic Route Selection (ARS) is a system programmable feature that automatically selects the least expensive route available at the time a long distance call is made. It is not necessary to dial the access code of the least expensive carrier.

The chart below shows the procedure of the ARS feature.

Flow Chart of ARS

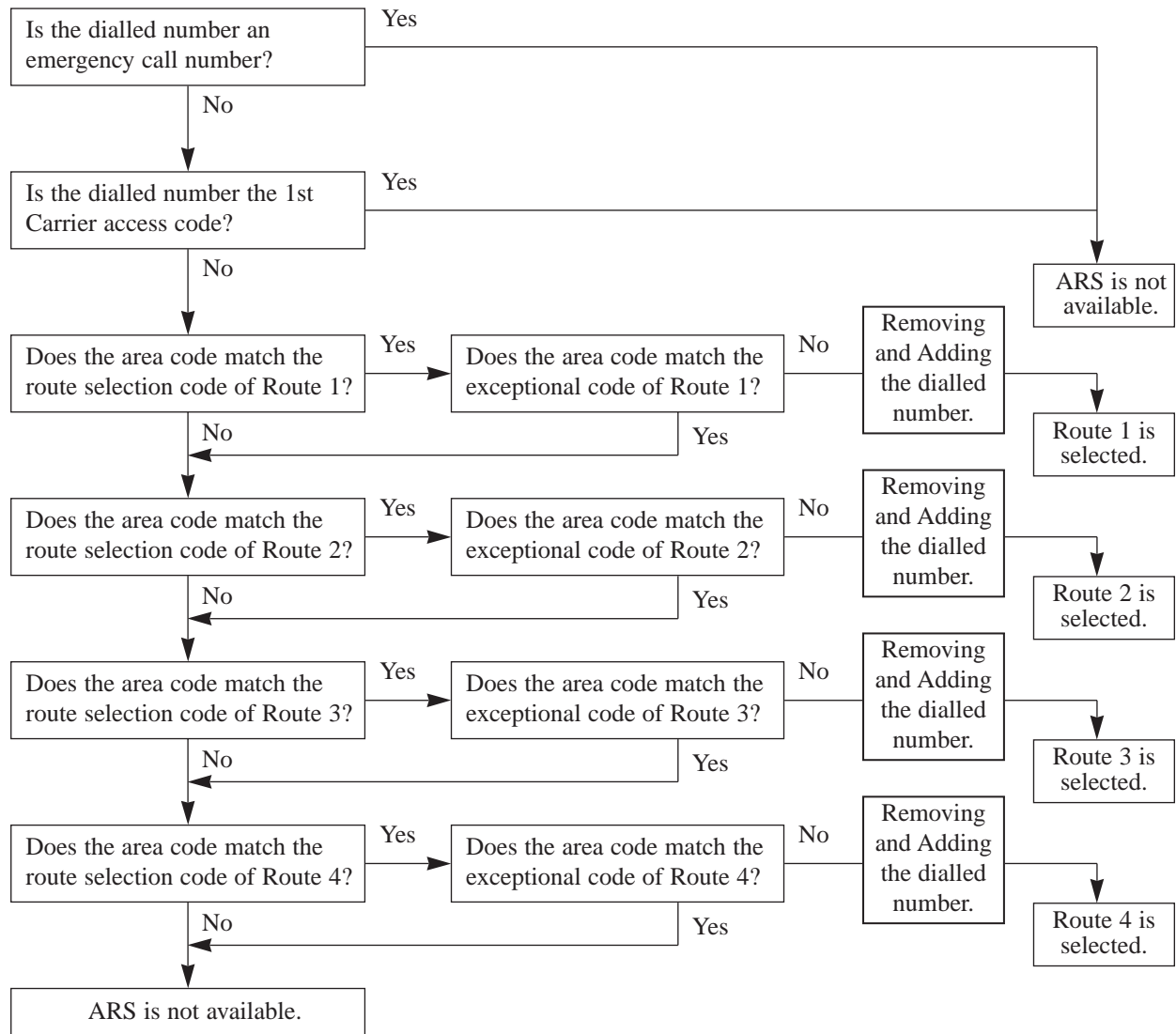

(Continued)

3.1 System Management

ARS Programming consists of the following items:

Common Table

(1) **ARS Mode** (Program [700])

This program is used to turn on or off the ARS mode. If turned on, calls are sent to the least expensive route to be used. (Default=Disable)

(2) **1st Carrier Access Code Set** (Program [705])

This program is used to store the 1st Carrier Access Code. (Default=Not stored) If the code is dialled, 1st Carrier is always selected even if the ARS mode is enabled.

ARS Routing Plan Tables (Routes 1 through 4)

(1) **ARS Carrier Code** (Program [701])

This is used to store each carrier's access code.

(2) **ARS Route Selection Code** (Program [702])

This is used to store area codes used for the ARS feature.

(3) **ARS Authorization Code** (Program [703])

This is used to register an authorization code applied to each ISDN line and each route.

(4) **ARS Itemized Bill Code** (Program [704])

This is used to assign whether to send an itemised bill code of an extension to each ISDN line or not. The itemised bill code corresponds to each extension number 21-28, 30 and 31-34.

(5) **ARS Route Exceptional Code** (Program [706])

This is used to store dialling numbers that are excepted from ARS routing plans of a specified carrier.

(6) **ARS Modify Removed Digit** (Program [708])

This is used to remove the digits of the dialled number before sending to the exchange line.

(7) **ARS Modify Added Number** (Program [709])

This is used to add the number to the dialled number before sending to the exchange line.

The dialled number is modified for sending out to the least expensive carrier. See below as an example.

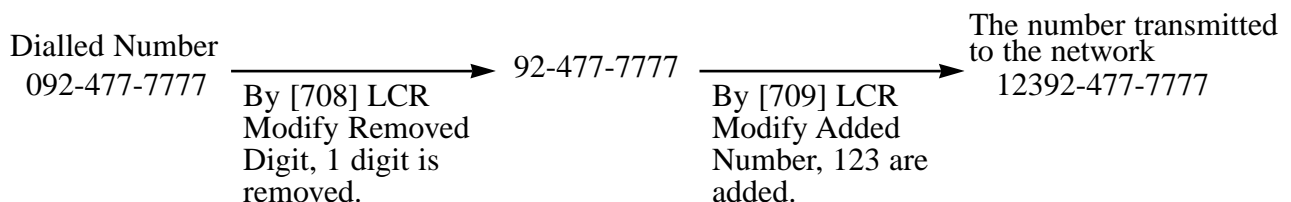

* For the example above, the carrier code, authorization code and itemized bill code are omitted.

3.1 *System Management*



- Emergency dial numbers are not applied to ARS and Toll Restriction.
- If you dial the carrier code directly, the numbers you dial after the carrier code will not be affected by either the ARS Modify Removed Digit or ARS Modify Added Number.



- Manager Programming (Section 3.3)
 - [002] Emergency Dial Number Set
- ARS Programming (Section 3.10)
 - [700] ARS Mode
 - [701] ARS Carrier Code
 - [702] ARS Route Selection Code
 - [703] ARS Authorization Code
 - [704] ARS Itemized Bill Code
 - [705] 1st Carrier Access Code
 - [706] ARS Route Exceptional Code
 - [708] ARS Modify Removed Digit
 - [709] ARS Modify Added Number

3.1 System Management

| | | | |
|--------------------------|-----|--------|----|
| Budget Management | SLT | ISDN-T | PT |
| | ✓ | ✓ | ✓ |

Limits the telephone usage to a pre-assigned amount. For example, the limit may be the amount deposited at check-in. If the pre-assigned limit is reached, the extension user cannot make further calls until he/she receives authorization from the manager.



- Manager Programming (Section 2.3)
[003] Budget Management

| | | | |
|-------------------------------|-----|--------|----|
| Class of Service (COS) | SLT | ISDN-T | PT |
| | ✓ | ✓ | ✓ |

COS is used to define the features which are allowed for a group of extensions. Each extension is assigned a primary and secondary COS numbers. Four classes are available.



- The manager can switch the extension's COS between a primary and secondary number.
- The programmable items are shown below:
 - 1) Outgoing call restriction level (Day mode / Night mode)
 - 2) Forwards a call to an outside party
 - 3) Overrides Do Not Disturb of the called extension
 - 4) Account Code Entry operation
 - 5) Sets Executive Busy Override
 - 6) Denies Executive Busy Override
 - 7) System speed dialling call restriction level (Day mode / Night mode)
 - 8) Unlocks the door
 - 9) Switches Day/Night mode
 - 10) Sets Do Not Disturb for Direct Dialling In Call
 - 11) Sets Call Forwarding – Follow Me
 - 12) Sets Connected Line Identification Restriction
 - 13) Sets Calling Line Identification Restriction

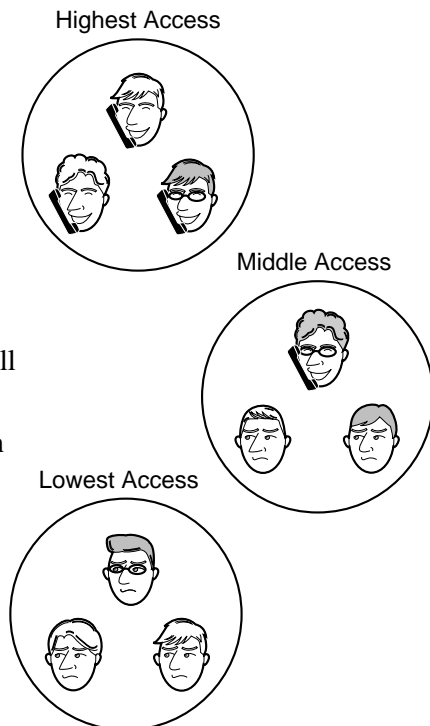

3.1 System Management



- COS Programming (Section 3.8)
 - [500]–[501] Toll Restriction Level — Day/Night
 - [503] Call Forwarding to outside line (CO)
 - [504] Do Not Disturb Override
 - [505] Account Code Entry Mode
 - [506]–[507] Toll Restriction Level for System Speed Dialling — Day/Night
 - [508] Door Opener Access
 - [509] Night Service Access
 - [510] Do Not Disturb for Direct Dialling In Call
 - [511] Call Forwarding — Follow Me
 - [512] Calling Line Identification Restriction (CLIR)
 - [513] Connected Line Identification Restriction (COLR)
 - [514] Executive Busy Override
 - [515] Executive Busy Override Deny
 - [517] Call Forwarding by ISDN Service
- Extension Programming (Section 3.9)
 - [601] Class of Service

| <i>Data Line Security</i> | SLT | ISDN-T | PT |
|---------------------------|-----|--------|----|
| | ✓ | | ✓ |

Once set, communication between the extension and the other party is protected from any signals such as Call Waiting, Hold Recall and Executive Busy Override. Data equipment or a facsimile may be connected to an extension jack so that the user can perform data communications. During communication, Data Line Security maintains secure data transmission against tones or interruptions from other extensions.



- If one extension in a conversation has set Data Line Security, it applies to both extensions.
- ISDN telephones are always in the data line security mode. This feature cannot be changed.



- Extension Programming (Section 3.9)
 - [612] Data Line Security

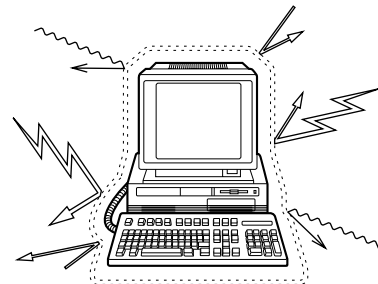

3.1 System Management

Direct Dialling In (DDI)

| SLT | ISDN-T | PT |
|-----|--------|----|
| ✓ | ✓ | ✓ |

Allows the external caller to connect to an extension in the system directly. Assignable destinations are: Manager, extension, or extension group. This requires a DDI number transmitted from the ISDN network. The DDI number is converted to a specific extension number by using a pre-programmed conversion table.

Explanation

1. An incoming call from the ISDN network reaches your DSHS (Digital Super Hybrid System). The ISDN network informs DSHS of the DDI number.
2. DSHS converts the DDI number to an extension number and directs the call to the extension.

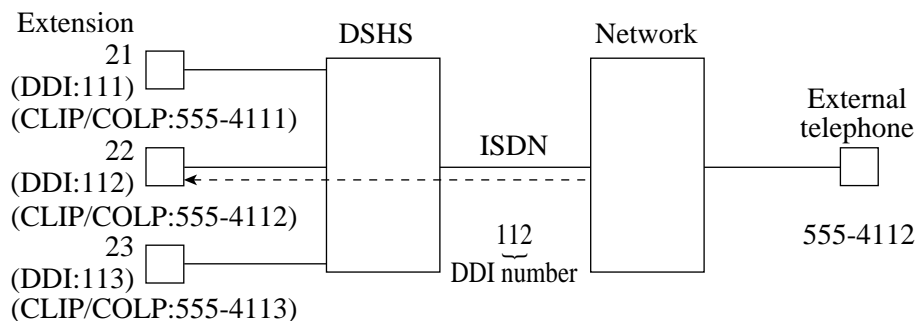

- You can store a DDI number (20 digits maximum) by System Programming.
- To reach an extension group, the group must have been previously set-up through System Programming.
- If a wrong number is entered, the call will be transferred to the manager.
- It is possible to use DND on a DDI call if the class of service permits.
- You can check the DDI number transmitted from the network by System Programming or PC Programming.



- ISDN Port Programming (Section 3.7)
 - [404] CLIP/COLP Number Assignment
 - [405] Direct Dialling In
 - [412] ISDN DDI Number/Extension Number Transformation
- COS Programming (Section 3.8)
 - [510] Do Not Disturb for Direct Dialling In Call
- Optional Programming (Section 3.12)
 - [902] System Additional Information,
 - Area 1 – Field (04)
 - Area 4 – Field (05–06)
 - [903] Received Number Check

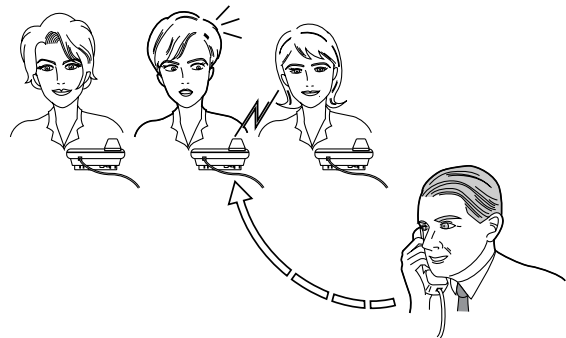

3.1 System Management

| | | | |
|------------------------------|-----|--------|----|
| Direct In Lines (DIL) | SLT | ISDN-T | PT |
| | ✓ | | ✓ |

Enables an incoming outside call to go directly to multiple answering points (**DIL 1:N**). Assignable destinations are extensions only. DIL 1:N can have different destinations for day and night modes (Night Service).

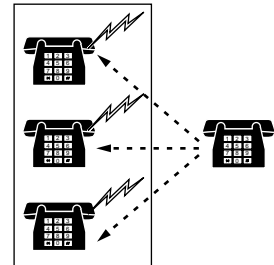

- Extension Programming (Section 3.9)
[603]–[604] DIL 1:N Extension and Delayed Ringing
— Day/Night

| | | | |
|------------------------|-----|--------|----|
| Extension Group | SLT | ISDN-T | PT |
| | ✓ | | ✓ |

The system supports eight extension groups. Any member of an extension group can pick up a call directed to another group member (Group Call Pickup). In addition, there are Ring Group, Station Hunting and Uniform Call Distribution (UCD) features.

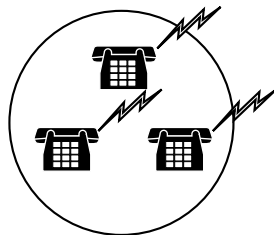

Extension Group 1

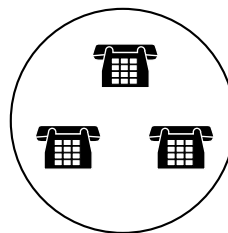

Extension Group 2



- Every extension should belong to an extension group but cannot belong to more than one group.



- System Programming (Section 3.4)
[102] Station Hunting Type
- Extension Programming (Section 3.9)
[602] Extension Group Assignment

3.1 System Management

| | | | |
|---------------------------------------|-----|--------|----|
| <i>EXtra Device Port (XDP)</i> | SLT | ISDN-T | PT |
| | ✓ | | ✓ |

An EXtra Device Port (XDP) expands the number of telephones available in the system by allowing an extension jack to contain two telephones. A digital proprietary telephone (DPT) and a single line telephone (SLT) can be connected to the same jack but have different extension numbers so that they can act as completely different extensions. All extension numbers in the XDP mode are fixed as follows:

- DPT extension number 21 — SLT extension number 31
- DPT extension number 22 — SLT extension number 32
- DPT extension number 23 — SLT extension number 33
- DPT extension number 24 — SLT extension number 34



- XDP requires previous programming of the individual extension. You can enable the XDP mode for the desired extension number by extension programming. Immediately after changing the assignment, the changed setting may not work for a maximum of eight seconds.
- If XDP is disabled for the extension, DPT and SLT may be used as Paralleled Telephones.



- Others (Section 2.6)
 - Setting the Paralleled SLT to Ring (Paralleled Telephone Connection)
- Extension Programming (Section 3.9)
 - [600] EXtra Device Port
- Connecting the Telephones in EXtra Device Port (XDP) (Section 4.11)

3.1 System Management

Forwarding a Doorphone Call to the Outside Line

| SLT | ISDN-T | PT |
|-----|--------|----|
| ✓ | ✓ | ✓ |

You can automatically transfer an incoming doorphone call to a preset outside destination.



- This feature works separately from other Call Forwarding settings.
- If there is no answer while the call is being forwarded, the forwarding will stop in one minute.
- Toll restriction and other restrictions such as an account code are not activated.
- A call is not recorded by SMDR for the Call Forwarding.
- There are two different modes for day and night. A different destination can be set in each mode. This feature can be set by System Programming.
- The CLIP number displayed at other party's extension is the number assigned at Extension 21.



- Extension Programming (Section 3.9)
[614]-[615] Doorphone Call Forwarding – Day/Night

Host PBX Access

| SLT | ISDN-T | PT |
|-----|--------|----|
| ✓ | ✓ | ✓ |

The system may be installed behind an existing host PBX which supports an Internal ISDN. This is performed by connecting a line from the host to a outside line (CO) in the system.



- To enable Host PBX Access, put the host PBX line on a outside line (CO). The user accesses the host PBX by selecting that outside line (CO).
- A Host PBX Access Code is required to access CO lines of the host PBX.



- ISDN Port Programming (Section 3.7)
[403] Host PBX Access Codes

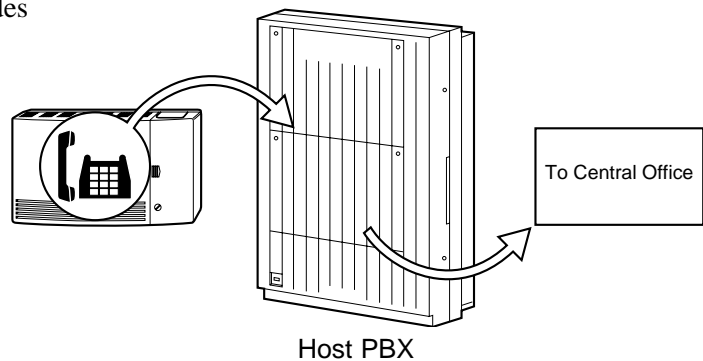

3.1 System Management

| | | | |
|--|-----|--------|----|
| <i>Integrated Services Digital Network (ISDN)</i> | SLT | ISDN-T | PT |
| | ✓ | ✓ | ✓ |

The system can assign which subscriber number is answered and which extension receives a call by ISDN point-to-multi-point configuration. A maximum of ten Multiple Subscriber Numbers (MSN) can be assigned to each ISDN bus with point-to-multi-point configuration.

Point-to-point

A call sent through one ISDN port reaches the pre-assigned extension directly with a Direct Dialling In (DDI) contract.

Point-to-multi-point

A call sent through one ISDN port reaches the multiple extensions. It is possible to assign multiple telephone numbers on an ISDN port basis.

When a call through the ISDN line with point-to-multi-point configuration reaches your unit;

- The call is refused if the dialled number does not match with the stored MSN.
- The call is connected to the pre-assigned extension if the dialled number is matched with the stored MSN.

If a MSN is not stored, the call sent through the ISDN line with a point-to-multi-point configuration reaches the extension by the standard method.



- ISDN Port Programming (Section 3.7)
 - [406] ISDN Configuration
 - [407] Multiple Subscriber Number Set
 - [408]–[409] Extension Ringing Assignment — Day/Night for ISDN
 - [410]–[411] ISDN Extension Ringing Assignment — Day/Night for ISDN
- ISDN Line Connection Structure (Section 4.7)
- Outside line (CO) Connection (Section 4.8)
- Expanding the ISDN Line Connection (Section 4.13)

3.1 System Management

| | | | |
|--|-----|--------|----|
| <i>Integrated Services Digital Network (ISDN) Extension</i> | SLT | ISDN-T | PT |
| | | ✓ | |

The system supports terminal equipment such as ISDN telephones, G4 Facsimiles and personal computers. A maximum of eight terminal equipments can be connected to the ISDN bus.

To use your ISDN extension within this system, program each ISDN extension number as follows:

Point-to-multi-point

- To have an individual ISDN extension number: **301 through 308**
- To have one ISDN extension number for all: **300**

Point-to-point

- To have one ISDN extension number: **30**

The following bearer capabilities can be supported:

| <u>Transfer Mode</u> | <u>Transfer Capability</u> |
|----------------------|----------------------------|
| Circuit | Unrestricted digital |
| Circuit | Speech |
| Circuit | 3.1 kHz Audio |



- Class of Service, department code, outgoing permission and IRNA assignment for the ISDN port apply to all terminal equipments on the same bus.



- Manager Programming (Section 3.3)
 - [003] Budget Management
- ISDN Port Programming (Section 3.7)
 - [406] ISDN Configuration
- ISDN Line Connection Structure (Section 3.7)
- Expanding the ISDN Line Connection (Section 4.13)

3.1 System Management

Intercept Routing

| SLT | ISDN-T | PT |
|-----|--------|----|
| ✓ | ✓ | ✓ |

Provides automatic redirection of incoming outside calls. There are two types that Intercept Routing occurs. In the first case, a call cannot be placed to the desired party. This is called Rerouting. In the second case, the call is not answered within a programmed time period. This is called Intercept Routing – No Answer (IRNA).

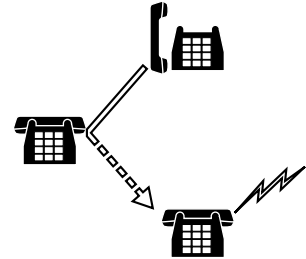

- Intercept Routing applies to DDI calls, DIL 1:N, Call Forwarding, and Station Hunting.
- The final destination of intercepted calls must be programmed for day and night modes. There are three possible destinations: extension, UCD group and Ring Group.
- If the destination is in Do Not Disturb, the call is redirected to the manager.
- IRNA can be enabled or disabled in program [610] “IRNA Assignment” (default: enabled). If enabled, rerouting is enabled.



- Timer Programming (Section 3.5)
 - [203] Intercept Time
- ISDN Port Programming (Section 3.7)
 - [401]–[402] Intercept Extension — Day/Night
- Extension Programming (Section 3.9)
 - [610] IRNA Assignment

3.1 System Management

| | | | |
|------------------------|-----|--------|----|
| Station Hunting | SLT | ISDN-T | PT |
| | ✓ | | ✓ |

If a called extension is busy, Station Hunting redirects the incoming call to an idle member of the extension group. Idle extensions are automatically hunted according to the programmed type. The following four hunting types are available;

Circular hunting: The extensions are hunted until an idle one is found, regardless of the jack number.

Termination hunting: The extensions are hunted until reaching the extension which has the highest jack number in the group.

UCD: Refer to Uniform Call Distribution (UCD) in this section.

Ring Group: All extensions in a ring group ring simultaneously.

One of the hunting types is selected for each extension group.

To leave the hunting group temporarily, use the Log-Out function. To re-join, use the Log-In function.

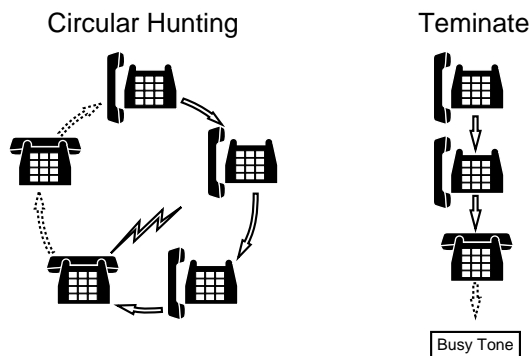

- If all of the hunted extensions are busy, a busy tone is sent to the caller.
- If the called extension has set Do Not Disturb, Call Forwarding or Log-Out, Station Hunting skips the extension.
- If UCD is set, Hunting is performed as a setting of UCD.



- System Programming (Section 3.4)
[102] Station Hunting Type
- Extension Programming (Section 3.9)
[602] Extension Group Assignment

3.1 System Management

| | | | |
|--|-----|--------|----|
| Station Message Detail Recording (SMDR) | SLT | ISDN-T | PT |
| | ✓ | ✓ | ✓ |

Station Message Detail Recording (SMDR) automatically records detailed call information for outside calls. A printer connected to the Serial Interface (RS-232C) port can be used to print incoming and outgoing outside calls and charge fees as well as print a hard copy of System Programming. To print a record of System Programming items that have been assigned, use the program [802] "System Data Printout." To print the charge fee, use Station Programming. To print the call records, use the program [800] "SMDR Incoming/Outgoing Call Log Printout," which allows you to print out the following records.

- All outgoing outside calls or outgoing toll calls
- Incoming outside calls

An example of printed call records:

| Date | Time | Ext | Dpc | Port | Dial Number | Duration | Cost:ZL | Acc | CD |
|----------|-------|-----|-------|------|-------------|----------|---------|-------|------|
| 10/02/99 | 10:00 | 21 | 12345 | 1 | 0344853233 | 00:05'12 | 12.00 | 12345 | |
| 10/02/99 | 10:10 | 23 | 00001 | 2 | <INCOMING> | 00:05'56 | 0.00 | | |
| 10/02/99 | 10:20 | 24 | 10 | 1 | <INCOMING> | 00:20'12 | 0.00 | 43121 | |
| 10/02/99 | 10:38 | 295 | | 1 | <INCOMING> | 00:10'01 | 0.00 | 43212 | TR |
| 10/02/99 | 13:40 | 28 | | 1 | <INCOMING> | 00:09'18 | 0.00 | 001 | FW |
| 10/02/99 | 14:42 | 21 | | 2 | <Private> | 00:03'10 | 17 | 11111 | |
| ⋮ | ⋮ | ⋮ | ⋮ | ⋮ | ⋮ | ⋮ | ⋮ | ⋮ | ⋮ |
| (1) | (2) | (3) | (4) | (5) | (6) | (7) | (8) | (9) | (10) |

Example of a SMDR printout format:

Explanation

- (1) Date : the date of the call as Day / Month / Year.
- (2) Time : the end time of a call as Hour:Minute.
- (3) Ext : the extension number, floating number, etc. that engaged in the call.
- (4) Dpc : the department code appended to the call.
- (5) Port : the ISDN port number used for the call.
- (6) Dial Number

Outgoing call: the other party's telephone number (maximum 22 digits). Valid digits are 0 through 9, *, #.

Received call: shows <INCOMING>. If the received call is a private call, <Private> is shown.

- (7) Duration : the duration of the call as Hour / Minutes / Seconds.
- (8) Cost: shows the amount of the charged fee; Pulse or ZL.
- (9) Acc : the account code appended to the call.
- (10) CD : the condition code.

TR : Transfer

FW : Call Forwarding to outside line (CO)

3.1 *System Management*



- “(8) Cost” is printed out as the charge indication of meter (no decimal point) or ZL. You can select the charge indication by System Programming.
- When programmed for outgoing toll calls only, printing occurs only for calls which start with the numbers stored in any Denied Code Table from levels 2 to 6.
- This system can store information on up to 100 calls. If more calls are initiated or received, stored records are deleted starting from the oldest one.
- This data is not deleted when you reset the system.
- If the account code stored in location 01 of the programming table is dialled, the dialled number is not printed out to SMDR (Private Call).



- Manager Programming (Section 3.3)
 - [000] Date and Time Set
- Resource Programming (Section 3.11)
 - [800] SMDR Incoming / Outgoing Call Log Printout
 - [801] SMDR Format
 - [802] System Data Printout
 - [804] Serial Interface (RS-232C) Parameters
- Connecting the Printer and PC (Section 4.15)

3.1 System Management

| | | | |
|--------------------------------|-----|--------|----|
| System Data Default Set | SLT | ISDN-T | PT |
| | ✓ | | ✓ |

This system allows re-initialisation of system-programmed data. If all of the programmed data is cleared, the system will restart using the default settings. You can select to clear **all of the programmed data** or **all of the programmed data except the ISDN data**. ISDN data which will not be cleared is as follows:

- a) Station Speed Dialling Numbers
- b) [001] System Speed Dialling Number Set
- c) [404] CLIP/COLP Number Assignment
- d) [405] Direct Dialling In
- e) [406] ISDN Configuration
- f) [407] Multiple Subscriber Number Set
- g) [412] ISDN DDI Number/Extension Number Transformation



- The default setting for each programming item is listed in Section 4.4 “Default Values.”
- System re-initialisation causes the system to terminate all calls or programs in progress.



- Optional Programming (Section 3.12)
 - [900] System Data All Clear
 - [901] System Data Clear Except ISDN Data

| | | | |
|--|-----|--------|----|
| System Programming with a Personal Computer | SLT | ISDN-T | PT |
| | | | |

This system can be programmed and administered using a personal computer (PC). A floppy disk for PC programming (included) is required to perform this feature.

On-Site Programming

By connecting a PC to your system, system programming can be performed locally. Connect the PC to the Serial Interface (RS-232C) port provided.



- Only one access is allowed to System Programming at any one time.
- To access system administration, a valid password must be entered.
- System administration can be performed on-line.



- System Programming (Section 3.4)
 - [103] System Password
- Connecting the Printer and PC (Section 4.15)

3.1 System Management

| | | | |
|-------------------------|-----|--------|----|
| Toll Restriction | SLT | ISDN-T | PT |
| | ✓ | ✓ | ✓ |

Toll Restriction is used in conjunction with the assigned Class of Service and can prohibit certain extension users from placing unauthorised toll calls.

Each Class of Service is programmed to have a toll restriction level for day mode and night mode.

There are eight toll restriction levels available. Toll restriction level 1 is the highest level and the level 8 is the lowest. Level 1 allows all toll calls and levels 7 and 8 prohibits all toll calls. Levels 2 through 6 are used to restrict calls by combining pre-programmed deny and excepted code tables.

Pre-assigned emergency numbers are allowed in any level.

Denied Code Tables

An outgoing outside call made by an extension with a toll restriction level between 2 and 6 is checked first against the selected Denied Code Tables. If the leading seven digits of the dialled number (not including the line access code) are not found in the table, the call is made. There are five system programs for Denied Code Tables: **[300]-[304] TRS**

Denied Code Entry for Levels 2 through 6.

Complete each table by storing numbers that are to be prohibited. These numbers are defined as denied codes. Each table can store up to 20 denied codes, each consisting of seven digits.

Excepted Code Tables

These tables are used to override a programmed denied code. A call denied by the selected Denied Code Tables is checked against the selected Excepted Code Tables. If a match is found, the call is made. There are five system programs for these tables: **[305]-[309] TRS**

Excepted Code Entry for Levels 2 through 6.

Complete each table by storing numbers that are exceptions to the denied codes. These numbers are defined as excepted codes. Each table can store up to 20 excepted codes, each consisting of seven digits.

Applicable Denied and Excepted Code Tables depend on the assigned toll restriction level of an extension as follows:

| | Denied Code Tables | Excepted Code Tables |
|---------|---------------------------|-------------------------------|
| Level 1 | None | None |
| Level 2 | Table for Level 2 | Tables for Levels 2 through 6 |
| Level 3 | Tables for Levels 2 and 3 | Tables for Levels 3 through 6 |
| Level 4 | Tables for Levels 2 to 4 | Tables for Levels 4 through 6 |
| Level 5 | Tables for Levels 2 to 5 | Tables for Levels 5 through 6 |
| Level 6 | Tables for Levels 2 to 6 | Tables for Level 6 |
| Level 7 | None | None |
| Level 8 | None | None |

(Continued)

3.1 System Management

[Explanation]

Level 1: allows all calls.

Level 2: denies the codes stored in the Denied Code Table for Level 2 except the codes stored in Excepted Code Tables for Levels 2 through 6.

Level 3: denies the codes stored in the Denied Code Tables for Levels 2 and 3 except the codes stored in Excepted Code Tables for Levels 3 through 6.

Level 4: denies the codes stored in the Denied Code Tables for Levels 2 through 4 except the codes stored in Excepted Code Tables for Levels 4 through 6.

Level 5: denies the codes stored in the Denied Code Tables for Levels 2 through 5 except the codes stored in Excepted Code Tables for Levels 5 and 6.

Level 6: • denies the codes stored in the Denied Code Tables for Levels 2 through 6 except the codes stored in Excepted Code Table for Level 6.
• denies intercom calls except manager calls.

Level 7: allows intercom calls only.

Level 8: allows manager calls only.

Example of Toll Restriction programming

Here is an example to explain the procedures for Toll Restriction programming.

1. Determining the application

Determine the dialling numbers that should be denied for levels 2 through 6. (Levels 1, 7 and 8 are fixed and do not require programming.)

[Entry Example]

| Level | Denied Code | Excepted Code |
|-------|---|--------------------|
| 2 | 011 | None |
| 3 | 011 976 1xxx976 | None |
| 4 | 011 976 1xxx976 0 | None |
| 5 | 011 976 1xxx976 0 411 1xxx555 | None |
| 6 | 011 976 1xxx976 0 411 1xxx555 1 x0 x1 | 911 1911 130 |

Note: "x" can be substituted with a digit.

3.1 System Management

2. Programming

(1) [500]-[501] Toll Restriction Level — Day/Night

Assign a toll restriction level to each Class of Service (COS).

[Example]

| COS | Level (Day) | Level (Night) |
|-----|-------------|---------------|
| 1 | 1 | 6 |
| 2 | 2 | 6 |
| 3 | 3 | 7 |
| 4 | 4 | 8 |

(2) [300]-[304] TRS Denied Code Entry for Levels 2 through 6

Depending on the application, enter the denied codes in the associated tables. You can use numeric characters and the wild card character “*.”

| Level 2 Denied Code Table | |
|---------------------------|------|
| Location | Code |
| 01 | 001 |
| : | |
| : | |
| 20 | |

| Level 3 Denied Code Table | |
|---------------------------|-----------|
| Location | Code |
| 01 | 976 |
| 02 | 1* * *976 |
| : | |
| 20 | |

| Level 4 Denied Code Table | |
|---------------------------|------|
| Location | Code |
| 01 | 0 |
| : | |
| : | |
| 20 | |

| Level 5 Denied Code Table | |
|---------------------------|-----------|
| Location | Code |
| 01 | 411 |
| 02 | 1* * *555 |
| : | |
| 20 | |

| Level 6 Denied Code Table | |
|---------------------------|------|
| Location | Code |
| 01 | 1 |
| 02 | *0 |
| 03 | *1 |
| : | |
| 20 | |

(3) [305]-[309] TRS Excepted Code Entry for Levels 2 through 6

Depending on the application, enter the excepted codes in the associated tables. You can use numeric characters and the wild card character “*.”

| Level 6 Excepted Code Table | |
|-----------------------------|------|
| Location | Code |
| 1 | 911 |
| 2 | 1911 |
| 3 | 130 |
| : | |
| 20 | |

[Explanation]

If your Toll Restriction Level is 6;

- You cannot make a call whose toll call number is “201,” because the number whose second digit “0” is one of the Denied Codes for Level 6.
- You can make a call whose toll call number is “130.” Though the number whose first digit “1” is one of the Denied Codes for Level 6, the number “130” is one of the Excepted Codes for Level 6. The Excepted Codes override the Denied Codes.

(Continued)

3.1 System Management

Flow Chart of Toll Restriction

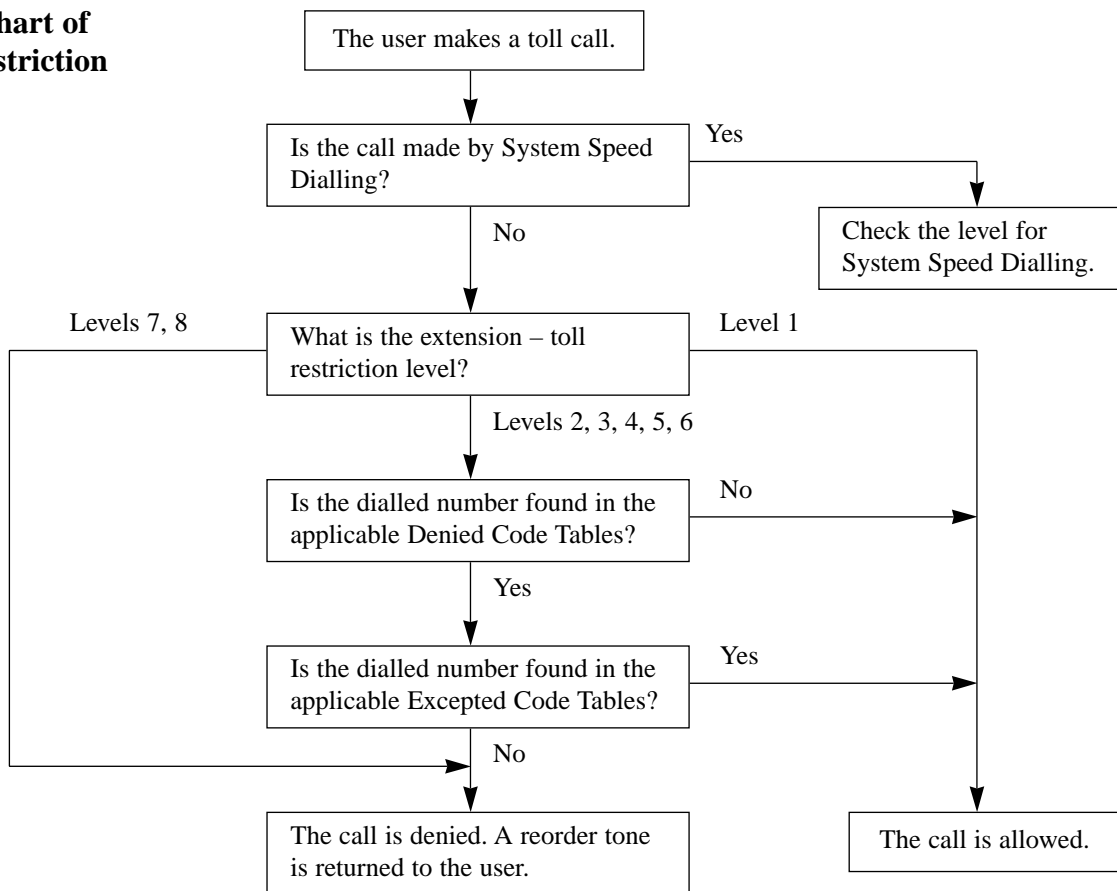

- Toll restriction checks are applied to the following:
 - (1) Account Code Entry
 - (2) Dial Access, Automatic
 - (3) Line Access, Individual
- If a stored Host PBX access code is found in the dialled number, a toll restriction check starts from the following telephone number.
- Toll restriction for System Speed Dialling can be assigned in a Class of Service setting.
- It is programmable whether “*” or “#” dialled by the user is to be checked or not with the Toll Restriction code. This is useful to prevent unauthorised calls which could be possible through certain Central Offices’ exchange systems.



- TRS Programming (Section 3.6)
 - [300]–[304] TRS Denied Code Entry for Levels 2 through 6
 - [305]–[309] TRS Excepted Code Entry for Levels 2 through 6
- COS Programming (Section 3.8)
 - [500]–[501] Toll Restriction Level — Day/Night
 - [506]–[507] Toll Restriction Level for System Speed Dialling — Day/Night
- Optional Programming (Section 3.12)
 - [902] System Additional Information, Area 2 – Field (03)

3.1 System Management

Toll Restriction Override by Account Code Entry

| SLT | ISDN-T | PT |
|-----|--------|----|
| ✓ | ✓ | ✓ |

Allows the extension user to override toll restriction temporarily to make a toll call from a toll-restricted telephone. The user can carry out this feature by entering the appropriate account code before dialling the telephone number.



- The toll restriction level of the user is changed to level 2 by this feature. Thus this can be used by extension users assigned to toll restriction levels 3 through 6. Levels 1 and 2 are not changed.
- A Class of Service which has assigned Account Code Entry – Verified Toll Restriction Override permits the class members to override their toll restrictions.
- If the user does not enter any account code or enters an invalid account code, an ordinary toll restriction check is done.



- COS Programming (Section 3.8)
[505] Account Code Entry Mode

Flow Chart of TRS Override by Account Code Entry

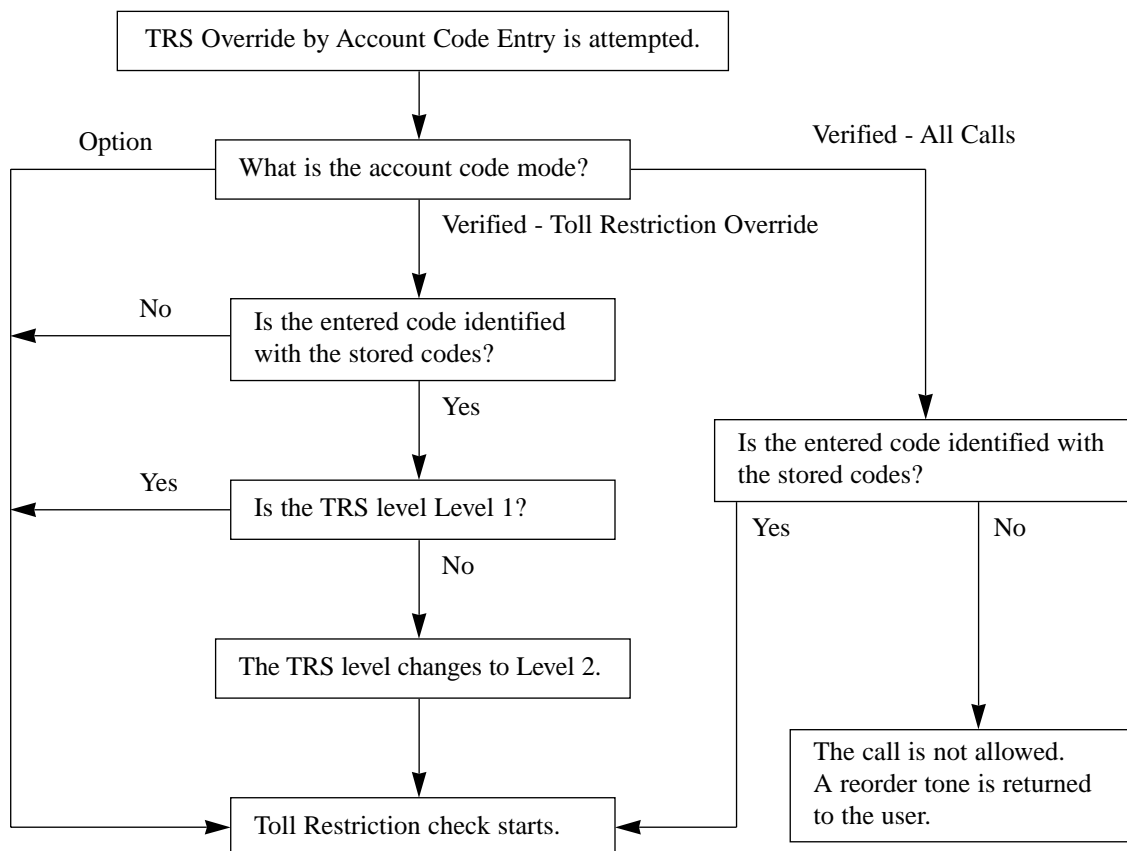

3.1 System Management

Toll Restriction Override for System Speed Dialling

| SLT | ISDN-T | PT |
|-----|--------|----|
| ✓ | ✓ | ✓ |

Calls originated by System Speed Dialling are restricted depending on the extension's toll restriction level for System Speed Dialling.



- Manager Programming (Section 3.3)
 - [001] System Speed Dialling Number Set
- COS Programming (Section 3.8)
 - [506]–[507] Toll Restriction Level for System Speed Dialling – Day/Night

Uniform Call Distribution (UCD)

| SLT | ISDN-T | PT |
|-----|--------|----|
| ✓ | | ✓ |

Allows incoming calls to be distributed uniformly to a specific group of extensions called an UCD group. Calls to an UCD group hunt for an idle extension in a circular way. This UCD feature is particularly helpful when a certain extension receives a high volume of calls compared with other extensions.



- Types of calls whose destination can be the UCD extension are:
 - Outside calls – DDI; IRNA
 - Intercom calls – Extension; Transfer
- This feature requires assignment of an UCD group for a Station Hunting type in System Programming. An extension cannot belong to two or more UCD groups.
- The floating number is assigned on an UCD group basis (291 through 298). The UCD group is based on the extension group.
- It is possible to set the log-in or log-out status on an extension basis.
- The extension which is assigned as a disconnect extension in program [609] should not belong to the extension group which is assigned as an UCD group.



- System Programming (Section 3.4)
 - [102] Station Hunting Type
- Extension Programming (Section 3.9)
 - [602] Extension Group Assignment

3.1 System Management

An outline sketch of an UCD is shown below.

(1) When a number of calls have arrived at an UCD group, the 1st call arrives at extension A first.

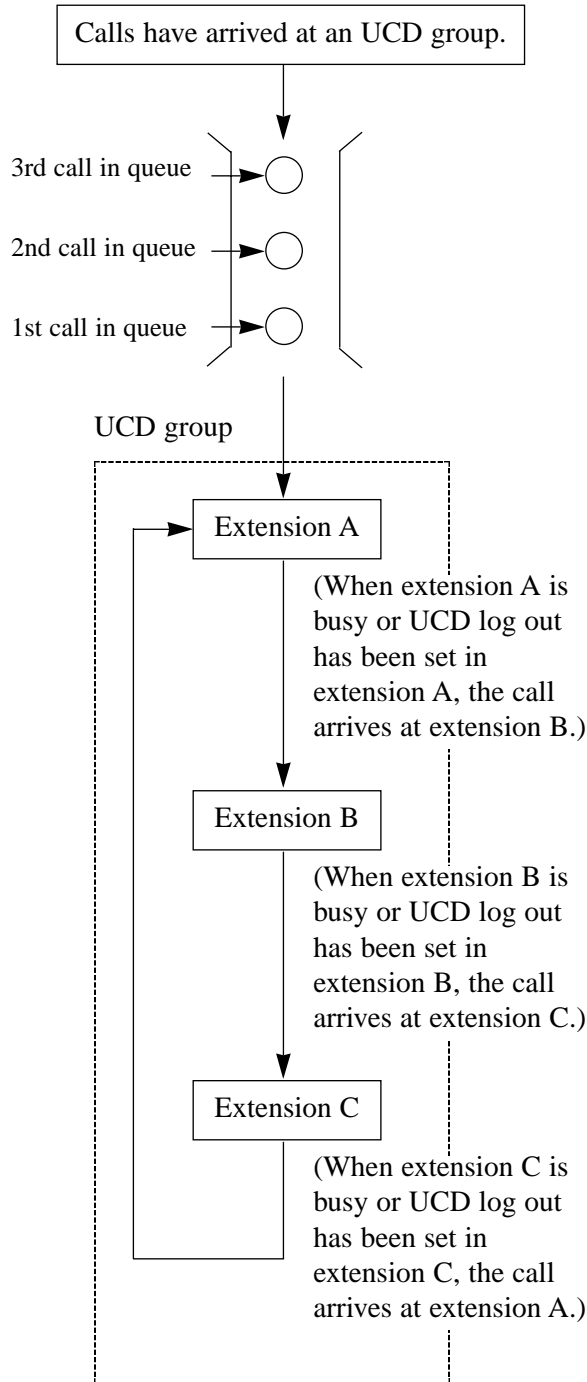

(2) When the 1st call arrives at extension A, the 2nd call arrives at extension B.

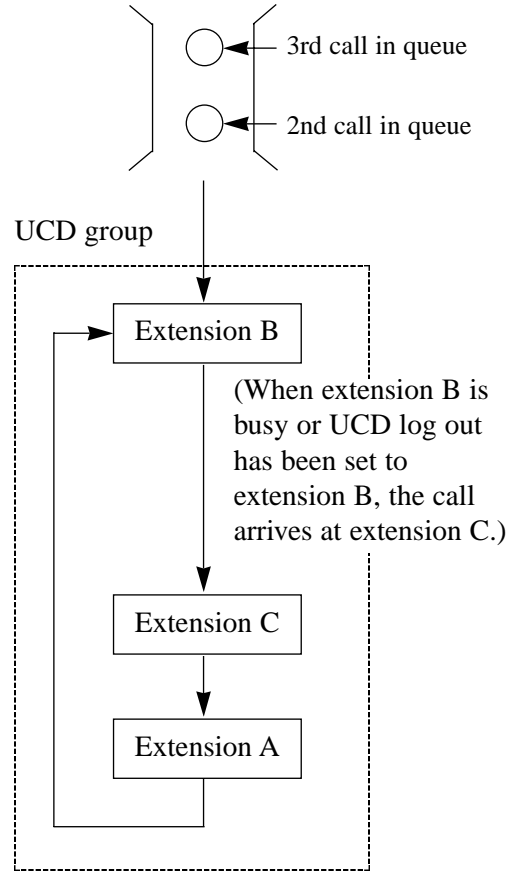

(3) When the 2nd call arrives at extension C, the 3rd call will arrive at extension A.

3.2 Before System Programming

Default Setting

This system has a default factory setting. If any of the programming needs to be changed, you can change the setting by System Programming.  represents the default factory setting (**DEFAULT**) and user-programmed data (**CHANGE**). Any required changes can be written in the (**CHANGE**) space or Programming Tables listed on pages 3-60 through 3-79.

Required Telephone Set

A proprietary telephone or tone type Single Line Telephone (SLT) is required for system programming.

Connect the telephone to either of the following:

- Jack number 1 (Extension number 21)
- Jack number 2 (Extension number 22)

Before entering the programming mode

Before entering the programming mode, confirm that:

- Your telephone is on-hook.
- No calls are on hold at your telephone.

To enter the programming mode

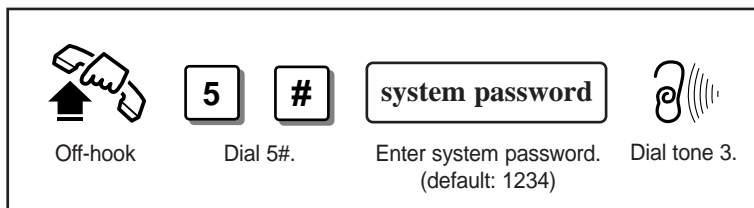

- The System Password can be changed by System Programming [103] "System Password."
- During the programming mode, your extension is treated as a busy extension.
- Only one telephone can be in programming mode at any one time.

Programming sequence

After entering the programming mode:

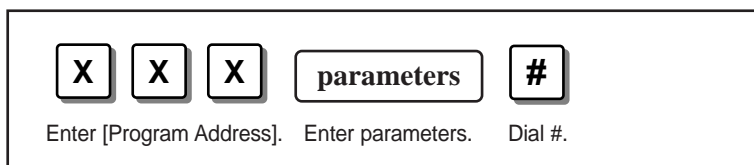

After pressing #, you will hear one of the following tones:

Confirmation tone 1 and then dial tone 3 :

This informs you that storing is completed. You can continue programming by entering the same or another program address.

Reorder tone : This informs you that the entry is invalid. Replace the handset and lift it again. Then you will hear dial tone 3. You can restart programming by entering the program address.

To exit the programming mode

Press  while hearing dial tone 3.

3.2 Before System Programming

Programming example

The following programming instructions assume that you have already entered the programming mode.

Example: Program [001] "System Speed Dialling Number Set"

Program address

Program title

[001] System Speed Dialling Number Set

Assigns a maximum of 100 System Speed Dial numbers. To delete the current entry, press # after entering the speed dial number.

0

0

1

speed dial no.

(00...99)

phone no.

24 digits max.

#

(0...9, ✕)

!

- Up to twenty-four digits, consisting of "0 through 9" and "✕," can be stored. Enter "✕ ✕" for a PAUSE. The PAUSE is counted as two digits.
- If you are storing an external number, include the ISDN port access code (9, 81 or 82) before the number.
- If you are storing an account code, enter the feature number, account code and the delimiter before the ISDN port access code. Enter "99" for the delimiter. (# is invalid.) Example: 49 12345 99 0 12345678
- System Speed Dial numbers are also used to indicate the caller's name on the display when receiving the call (**Caller Identification Service**). To utilize this service, you must store the caller's phone number with "-" (hyphen) after the line access code by PC Programming. The caller's names can be programmed by PC Programming.

DEFAULT Not stored.
CHANGE The Programming Tables are on pages 3-60 and 3-61.

Program description

Program sequence:

1. Enter program address "001".
2. Enter the speed dial number (00 through 99).
3. Enter the phone number (24 digits max. consisting of 0 through 9 and ✕).
4. Press #.

Additional information

Provides the default factory setting (**DEFAULT**) and user-programmed data (**CHANGE**). If you change the setting, write the programmed data in the programming table on the indicated page, or check the provided box (), or write the entry in the provided underline space (____).

Additional Information

- Jack numbers 1 through 8 correspond to extension numbers 21 through 28 respectively.
- If ISDN port 2 is assigned as an ISDN extension, the ISDN extension numbers can be 300, or 301 through 308.
- If you want to assign all extensions, ISDN ports, or COS to one selection, press ✕ instead of entering the number.
- System Programming is also available using a personal computer. Refer to Section 3.13 "PC Programming."

[000] Date and Time Set

Sets the current date and time.

| | | | | | | | | | |
|---|---|---|-----------|-----------|-----------|---------|-----------|-----------|---|
| 0 | 0 | 0 | day | month | year | week* | hour | minute | # |
| | | | (01...31) | (01...12) | (00...99) | (1...7) | (00...23) | (00...59) | |

* Day of the week selection number:

1 (Sunday) / 2 (Monday) / 3 (Tuesday) / 4 (Wednesday) /
5 (Thursday) / 6 (Friday) / 7 (Saturday)



- After changing an entry, you can press #. You do not have to perform the rest of the steps. For example, if you only want to change the month, enter [000][day][month][#].
- The time is adjusted automatically, if the first outgoing call is made via an ISDN line after three o'clock each morning.

DEFAULT 1 Jan '99 FRI 00:00

[001] System Speed Dialling Number Set

Assigns a maximum of 100 System Speed Dial numbers. To delete the current entry, press # after entering the speed dial number.

| | | | | | |
|---|---|---|----------------|------------------------------|---|
| 0 | 0 | 1 | speed dial no. | phone no. | # |
| | | | (00...99) | 24 digits max. (0...9, *) | |



- Up to twenty-four digits, consisting of “0 through 9” and “*,” can be stored. Enter “* *” for a PAUSE. The PAUSE is counted as two digits.
- If you are storing an external number, include the ISDN port access code (9, 81 or 82) before the number.
- If you are storing an account code, enter the feature number, account code and the delimiter before the ISDN port access code. Enter “99” for the delimiter. (# is invalid.)
Example: 49 12345 99 0 12345678
- System Speed Dial numbers are also used to indicate the caller’s name on the display when receiving the call (**Caller Identification Service**).
To utilize this service, you must store the caller’s phone number with “-” (hyphen) after the line access code by PC Programming. The caller’s names can be programmed by PC Programming.

DEFAULT Not stored.

CHANGE The Programming Tables are on pages 3-60 and 3-61.



[002] *Emergency Dial Number Set*

Stores four emergency call numbers. To delete the current entry, press # after entering the emergency code number.

| | | | | | |
|---|---|---|--------------------|---------------------------|---|
| 0 | 0 | 2 | emergency code no. | emergency no. | # |
| | | | (1...4) | 16 digits max. (0...9) | |

 **DEFAULT** Not Stored.
CHANGE Code 1 _____ Code 2 _____ Code 3 _____ Code 4 _____

[003] *Budget Management*

Assigns the total call charge limitation on an extension basis. If it is set “0,” no restriction is applied.

| | | | | | |
|---|---|---|----------------|-------------------|---|
| 0 | 0 | 3 | extension no.* | charge limitation | # |
| | | | | (0...9999) | |

* Extension number: 21 through 28, 31 through 34 (standard extension) /
 30 (all ISDN extensions) / *

 **Default** 0 (No limitation)
CHANGE The Programming Table is on page 3-61.

[100] Day/Night Service Starting Time

Sets the starting time on a day of the week basis, when automatic day/night switching is selected. To select the non-switching mode, press # after entering the day or night selection number.

1 0 0 week* X hour minute #
(1...7,*) (1...2) (00...23) (00...59)

* Day of the week selection number number: 1 (Sunday) / 2 (Monday) / 3 (Tuesday) / 4 (Wednesday) / 5 (Thursday) / 6 (Friday) / 7 (Saturday) / * (every day)

X – Day or night selection number: 1 (Day) / 2 (Night)

DEFAULT Every day – Day – 9:00 / Night – 17:00



| | | | | | | | | |
|---------------|-----------|------|------|------|------|------|------|------|
| CHANGE | Every day | Sun. | Mon. | Tue. | Wed. | Thu. | Fri. | Sat. |
| Day | | | | | | | | |
| Night | | | | | | | | |

[101] Account Codes

Assigns a maximum of 40 account codes for the Account Code Entry, Verified – All Calls and Verified – Toll Restriction Override modes. To delete the current entry, press # after entering the location number.

1 0 1 location no. account code #
(01...40) 5 digits max. (0...9)



- Account codes having “99” in any part or ending with “9” are invalid (e.g. 12993, 12349), as “99” is used as a delimiter when entering an account code.
- The entry location 01 is used as the account code for a Private Call.

DEFAULT Not stored.



CHANGE The Programming Table is on page 3-61.

[102] Station Hunting Type

Assigns the Station Hunting type for each extension group. The available Station Hunting types are: Circular, Termination, Uniform Call Distribution (UCD) and Ring Group.

1 0 2 extension group no. hunting type no.* #
(1...8,*) (1...5)

* Hunting Type number:

1 (no hunting) / 2 (Termination) / 3 (Circular) / 4 (UCD) / 5 (Ring Group)



DEFAULT All extension groups – No hunting

CHANGE The Programming Table is on page 3-61.

[103] System Password

Assigns the password required for entering the System Programming mode and used for personal computer maintenance.

4 to 7 digits max.
 (0...9)

DEFAULT 1234
CHANGE _____

[104] Pulse Dial Reception Assignment

Assigns whether the pulse dial from an extension can be received or not by the system.

(1...2)

X – Pulse dial reception selection number: 1 (Enable) / 2 (Disable)

DEFAULT Enable
CHANGE Disable

[105] Automatic Door Open Assignment

Assigns whether the door is automatically unlocked or not, when pressing the Call button on the doorphone.

(1...2) (1...2)

X – Day or night selection number: 1 (Day) / 2 (Night)

Y – Automatic door open selection number: 1 (Enable) / 2 (Disable)



DEFAULT Both day and night – Disable
CHANGE Both day and night – Enable
 Day – Enable, Night – Disable
 Day – Disable, Night – Enable

[107] Charge Indication Selection

Assigns the initial indication format of a charge fee on the SMDR.

1 **0** **7** **X** **#**
 (1...2)

X – Charge indication selection number: 1 (Frequency) / 2 (Charge)

 **DEFAULT** Charge
CHANGE Frequency

[108] Charge Verification ID Code Set

Assigns an ID code required to refer to the charge information.

1 **0** **8** **ID code** **#**
 4 digits
 (0000...9999)

 **DEFAULT** 1234
CHANGE _____

[109] One-Touch Transfer by DSS Button Set

Enables or disable the automatic outside call hold when a DSS button is pressed.

1 **0** **9** **X** **#**
 (1...2)

X – Selection number: 1 (Enable) / 2 (Disable)

 **DEFAULT** Enable
CHANGE Disable

[200] Hold Recall Time

Assigns the length of the Hold Recall timer. Select “0” if Hold Recall is not required.

(0...240 seconds)

 **DEFAULT** 60 seconds
CHANGE _____ seconds No Hold Recall

[201] Transfer Recall Time

Assigns the number of rings before Transfer Recall occurs.
One ring is equivalent to 5 seconds.

(3...48)

 **DEFAULT** 12 rings
CHANGE _____ rings

[202] Call Forwarding — No Answer Time

Assigns the number of rings for the Call Forwarding — No Answer feature.
One ring is equivalent to 5 seconds.

(1...12)

 **DEFAULT** 3 rings
CHANGE _____ rings

[203] Intercept Time

Assigns the number of rings for the Intercept Routing — No Answer (IRNA) feature. One ring is equivalent to 5 seconds.

2 **0** **3** **no. of rings** **#**
(3...48)

 **DEFAULT** 12 rings
CHANGE _____ rings

[204] Pickup Dial Waiting Time

Assigns the number of seconds for Pickup Dialling. When the timer expires after lifting the handset, the programmed party is called automatically.

2 **0** **4** **time** **#**
(1...8 seconds)

 **DEFAULT** 1 second
CHANGE _____ seconds

[205] DTMF Sending PAUSE Time

Assigns the starting time for sending out the DTMF signalling to the ISDN Network.

2 **0** **5** **X** **#**
(1...6)

X – X + 0.5 sec.

 **DEFAULT** 1.5 seconds (1 + 0.5 sec.)
CHANGE _____ seconds

[206] Door Opener Time

Assigns the time to keep the door open. If “0” is assigned, the system will keep the door open until the controlling telephone hangs up.

2 **0** **6** **time** **#**
(0...99 seconds)

 **DEFAULT** 5 seconds
CHANGE _____ seconds

[207] Message Waiting Ring Interval Time

Sets the Message Waiting ring interval time for a single line telephone.

2 **0** **7** **#**
(0...64 minutes)



- When the internal time is set “0”, the telephone does not ring for Message Waiting Notification.



DEFAULT 10 minutes
CHANGE _____ minutes

[208] Automatic Redial Repeat Time

Sets the number or times Automatic Redial is tried. Automatic redialling of the last dialled or saved number is done up to the specified number of times.

2 **0** **8** **#**
(0...8 times)



DEFAULT 4 times
CHANGE _____ times

[209] Automatic Redial Interval Time

Sets the interval time between Automatic Redial attempts.

2 **0** **9** **#**
3...120 (× 10 is the actual time)



DEFAULT 12 (× 10) seconds
CHANGE _____ seconds

[300]–[304] TRS Denied Code Entry for Levels 2 through 6

These allow you to specify which numbers are toll-restricted for each toll restriction level as follows:

Program [300]: restricts levels 2 through 6

Program [301]: restricts levels 3 through 6

Program [302]: restricts levels 4 through 6

Program [303]: restricts levels 5 through 6

Program [304]: restricts level 6

To delete the current entry, press # after entering the location number.

| | | | | | |
|----------|----------|----------|--------------|------------------------------|----------|
| 3 | 0 | X | location no. | restricted no. | # |
| | | (0...4) | (01...20) | 7 digits max. (0...9, *)* | |

X – Program address selection number: 0 ([300]) / 1 ([301]) / 2 ([302]) / 3 ([303]) / 4 ([304])

* The character “*” can be used as a wild card character.



DEFAULT All locations – Not stored.

CHANGE The Programming Table is on page 3-62.

[305]–[309] TRS Excepted Code Entry for Levels 2 through 6

These allow you to assign numbers which are exceptions to the toll restriction specified in programs [300] through [304] as follows:

Program [305]: applies to level 2

Program [306]: applies to levels 2 through 3

Program [307]: applies to levels 2 through 4

Program [308]: applies to levels 2 through 5

Program [309]: applies to levels 2 through 6

To delete the current entry, press # after entering the location number.

| | | | | | |
|----------|----------|----------|--------------|------------------------------|----------|
| 3 | 0 | X | location no. | excepted no. | # |
| | | (5...9) | (01...20) | 7 digits max. (0...9, *)* | |

X – Program address selection number: 5 ([305]) / 6 ([306]) / 7 ([307]) / 8 ([308]) / 9 ([309])

* The character “*” can be used as a wild card character.



DEFAULT All locations – Not stored.

CHANGE The Programming Table is on page 3-63.

[400] ISDN Port Connection Assignment

Used to identify the ISDN ports which are connected to the system. This prevents users from originating a call from a line which is not connected.

4 **0** **0** **ISDN port no.** **X** **#**
 (1...2,*) (1...2)

X – ISDN port connection selection number: 1 (Connect) / 2 (Not connect)

 **DEFAULT** ISDN port 1 – Connect / ISDN port 2 – Not connect
CHANGE The Programming Table is on page 3-62.

[401]–[402] Intercept Extension — Day/Night

Assigns the destination extension number in day and night modes for Intercept Routing. To disable Intercept Routing, press # after entering the ISDN port number.

4 **0** **X** **ISDN port no.** **extension no.*** **#**
 (1...2) (1...2,*)

X – Program address selection number: 1 ([401] for day) / 2 ([402] for night)

* Extension number: 21 through 28, 31 through 34 (standard extension) /
 30 (all ISDN extensions) /
 291 through 298 (UCD, Ring Group)

 **DEFAULT** All ISDN ports – Disable
CHANGE The Programming Table is on page 3-62.

[403] Host PBX Access Codes

Assigns Host PBX access codes. To delete the current entry, press # after entering the location number.

4 **0** **3** **ISDN port no.** **location no.** **access code** **#**
 (1...2,*) (1...4) 1 or 2 digits
 (0...9)

 • If conflicting access codes (such as 8 and 81) are stored for the same ISDN port, only the 1-digit code (8) will be affected.

 **DEFAULT** All ISDN ports – Not stored.
CHANGE The Programming Table is on page 3-62.

[404] CLIP/COLP Number Assignment

Assigns the Calling Line Identification Presentation (CLIP) and Connected Line Identification Presentation (COLP) numbers. You can classify both CLIP and COLP numbers into the business and private modes.

4 **0** **4** **ISDN port no.** **extension no.*** **X** **CLIP/COLP no.** **#**
 (1...2,*) (1...4,*) 20 digits max. (0...9)

* Extension number: 21 through 28, 31 through 34 /
 301 through 308 (ISDN extension) /
 300 (all ISDN extensions)

X – CLIP / COLP Classification 1 : CLIP no. — Business
 2 : CLIP no. — Private
 3 : COLP no. — Business
 4 : COLP no. — Private
 * : All



• To delete the entry, press # after CLIP / COLP Classification.



DEFAULT All CLIP/COLP numbers – Not stored.
CHANGE The Programming Table is on pages 3-63 through 3-65.

[405] Direct Dialling In

Assigns the contract status of the Direct Dialling In (DDI) service on an ISDN port basis.

4 **0** **5** **ISDN port no.** **X** **#**
 (1...2,*) (1...2)

X – DDI service selection number: 1 (Enable) / 2 (Disable)



DEFAULT All ISDN ports – Enable
CHANGE The Programming Table is on page 3-62.

[406] ISDN Configuration

Assigns the configuration on an ISDN port basis as stated in the ISDN contract. If you change the assignment, reset the system so that the assignment will be activated.

4 **0** **6** **ISDN port no.** **X** **#**
 (1...2,*) (1...4)

X – Configuration selection number: 1 (outside line (CO) / Point-to-multi-point)
 2 (outside line (CO) / Point-to-point)
 3 (Extension line / Point-to-multi-point)
 4 (Extension line / Point-to-point)

 **DEFAULT** All ISDN ports – outside line (CO) / Point-to-multi-point
CHANGE The Programming Table is on page 3-62.

[407] Multiple Subscriber Number Set

Assigns a maximum of ten multiple subscriber numbers (MSN) on an ISDN port basis. To delete the current entry, press # after entering the location number.

4 **0** **7** **ISDN port no.** **location no.** **MSN** **#**
 (1...2,*) (01...10) 16 digits max.
 (0...9)

 **DEFAULT** All locations – Not stored.
CHANGE The Programming Table is on page 3-64.

[408]–[409] Extension Ringing Assignment — Day/Night for ISDN

Determines which extension receives a call and the notification method on a multiple subscriber number (MSN) basis for the ISDN port in the day and night modes.

You can continuously program up to eight extensions before pressing #. To delete the current entry, press # after entering the location number.

4 **0** **X** **ISDN port no.** **location no.** **extension no.** **Y** **#**
 (8...9) (1...2,*) (21...28, 31...34) (0, 1, 3, 6, 9)

X – Program address selection number: 8 ([408] for day) / 9 ([409] for night)
Y – Delayed ringing selection number: 0 (Immediate ringing) / 1 (1 ring delay) /
 3 (3 rings delay) / 6 (6 rings delay) / 9 (disable)

 **DEFAULT** All locations – All extensions – Immediate ringing (in both modes)
CHANGE The Programming Table is on pages 3-65 through 3-68.

[410]–[411] ISDN Extension Ringing Assignment — Day/Night for ISDN

Determines which ISDN extension receives a call on a multiple subscriber number (MSN) basis for the ISDN port in the day and night modes. To delete the current entry, press # after entering the location number.

| | | | | | | |
|----------|----------|----------|----------------------|---------------------|----------------------------|----------|
| 4 | 1 | X | ISDN port no. | location no. | ISDN extension no.* | # |
| | | | (0...1) | (1...2,*) | (01...10) | |

X – Program address selection number: 0 ([410] for day) / 1 ([411] for night)

* ISDN extension number: 301 through 308 (ISDN extension) /
300 (all ISDN extensions)



DEFAULT All locations – Not stored.

CHANGE The Programming Table is on page 3-69.

[412] ISDN DDI Number/Extension Number Transformation

Used to convert a DDI number to an extension number in order to put an incoming DDI call to a specific extension.

| | | | | | | |
|----------|----------|----------|----------------------|-----------------------|------------------------|----------|
| 4 | 1 | 2 | ISDN port no. | extension no.* | DDI no. | # |
| | | | (1...2,*) | | 20 digits max. (0...9) | |

* Extension number: 21 through 28, 31 through 34 (standard extension) /
291 through 298 (UCD Group or Ring Group) /
301 through 308 (ISDN extension) /
300 (all ISDN extensions)



- Please see [903] for your reference.
- To delete the entry, press # after the extension number.



DEFAULT All DDI numbers – Not stored.

CHANGE The Programming Table is on page 3-70.

[500]–[501] Toll Restriction Level — Day/Night

Assigns the toll restriction value for each Class of Service (COS) in the day or night mode.

5 **0** **X** **COS no.** **level no.** **#**
 (0…1) (1…4,*) (1…8)

X – Program address selection number: 0 ([500] for day) / 1 ([501] for day)

DEFAULT All COS – Level 1 (in both modes)

CHANGE The Programming Table is on page 3-71.

**[503] Call Forwarding to Outside Line (CO)**

Enables or disables the Call Forwarding to a outside line (CO) function on a Class of Service (COS) basis.

5 **0** **3** **COS no.** **X** **#**
 (1…4,*) (1…2)

X – Selection number: 1 (Enable) / 2 (Disable)

DEFAULT All COS – Enable

CHANGE The Programming Table is on page 3-71.

**[504] Do Not Disturb Override**

Enables or disables the Do Not Disturb Override function on a Class of Service (COS) basis.

5 **0** **4** **COS no.** **X** **#**
 (1…4,*) (1…2)

X – Selection number: 1 (Enable) / 2 (Disable)

DEFAULT All COS – Disable

CHANGE The Programming Table is on page 3-71.

**[505] Account Code Entry Mode**

Determines the account code mode to be used on a Class of Service (COS) basis.

5 **0** **5** **COS no.** **X** **#**
 (1…4,*) (1…3)

X – Account code entry mode selection number:

1 (Option) / 2 (Verified – All Calls) / 3 (Verified – Toll Restriction Override)

DEFAULT All COS – Option mode

CHANGE The Programming Table is on page 3-71.



[506]–[507] *Toll Restriction Level for System Speed Dialling* — *Day/Night*

Assigns the toll restriction value used in System Speed Dialling for each Class of Service (COS) in the day or night mode.

(6…7) (1…4,*) (1…8)

X – Program address selection number: 6 ([506] for day) / 7 ([507] for night)



DEFAULT All COS – Level 1 (in both modes)

CHANGE The Programming Table is on page 3-71.

[508] *Door Opener Access*

Assigns whether each extension has access to the door opener or not.

(1…4,*) (1…2)

X – Selection number: 1 (Enable) / 2 (Disable)



DEFAULT All COS – Enable

CHANGE The Programming Table is on page 3-71.

[509] *Night Service Access*

Enables or disables switching the Day/Night service on a Class of Service (COS) basis. The manager can switch the mode regardless of the setting.

(1…4,*) (1…2)

X – Selection number: 1 (Enable) / 2 (Disable)



DEFAULT All COS – Enable

CHANGE The Programming Table is on page 3-71.

[510] Do Not Disturb for Direct Dialling In Call

Enables or disables the Do Not Disturb for Direct Dialling In Call function on a Class of Service (COS) basis. The manager cannot reject a call regardless of the setting.

5 **1** **0** **COS no.** **X** **#**
(1...4,*) (1...2)

X – Selection number: 1 (Enable) / 2 (Disable)



DEFAULT All COS – Disable

CHANGE The Programming Table is on page 3-72.

[511] Call Forwarding — Follow Me

Enables or disables the Call Forwarding – Follow Me function on a COS basis.

5 **1** **1** **COS no.** **X** **#**
(1...4,*) (1...2)

X – Selection number: 1 (Enable) / 2 (Disable)



DEFAULT All COS – Enable

CHANGE The Programming Table is on page 3-72.

[512] Calling Line Identification Restriction (CLIR)

Enables or disables the Calling Line Identification Restriction (CLIR) service on a Class of Service (COS) basis.

5 **1** **2** **COS no.** **X** **#**
(1...4,*) (1...2)

X – Selection number: 1 (Enable) / 2 (Disable)



DEFAULT All COS – Disable

CHANGE The Programming Table is on page 3-72.

[513] Connected Line Identification Restriction (COLR)

Enables or disables the Connected Line Identification Restriction (COLR) service on a Class of Service (COS) basis.

5 **1** **3** **COS no.** **X** **#**
(1...4,*) (1...2)

X – Selection number: 1 (Enable) / 2 (Disable)



DEFAULT All COS – Disable

CHANGE The Programming Table is on page 3-72.

[514] Executive Busy Override

Enables or disables the Executive Busy Override function on a Class of Service (COS) basis.

5 **1** **4** **COS no.** **X** **#**
(1...4, *) (1...2)

X – Selection number: 1 (Enable) / 2 (Disable)



DEFAULT All COS – Disable

CHANGE The Programming Table is on page 3-72.

[515] Executive Busy Override Deny

Enables or disables the Executive Busy Override Deny function on a Class of Service (COS) basis.

5 **1** **5** **COS no.** **X** **#**
(1...4, *) (1...2)

X – Selection number: 1 (Enable) / 2 (Disable)



DEFAULT All COS – Enable

CHANGE The Programming Table is on page 3-72.

[517] Call Forwarding by ISDN Service

Enables or disables the Call Forwarding by ISDN service function on a Class of Service (COS) basis.

5 **1** **7** **COS no.** **X** **#**
(1...4, *) (1...2)

X – Selection number: 1 (Enable) / 2 (Disable)



- The availability of this feature depends on your local ISDN services.



DEFAULT All COS – Disable

CHANGE The Programming Table is on page 3-72.

[600] *EXtra Device Port*

Assigns which extensions have the Extra Device Port (XDP).

(21...24) (1...2)

X – Selection number: 1 (Enable) / 2 (Disable)



- You cannot enter your own extension number.

DEFAULT All extensions – Disable

CHANGE The Programming Table is on page 3-72.

[601] *Class of Service*

Programs each extension a Class of Service (COS). There are a maximum of four Class of Services. A primary and a secondary COS number can be assigned per extension.

(1...4) (1...4)

* Extension number: 21 through 28, 31 through 34 (standard extension) /
30 (all ISDN extensions) / *



- Every extension must be assigned to a Class of Service and is subject to COS Programming for programs [500] through [514].

DEFAULT All extensions – COS 1

CHANGE The Programming Table is on page 3-72.

[602] *Extension Group Assignment*

Assigns each extension to an extension group. There is a maximum of eight extension groups. Each extension can belong to only one group.

(1...8)

* Extension number: 21 through 28, 31 through 34 (standard extension) / *



DEFAULT All extensions – Extension group 1

CHANGE The Programming Table is on page 3-72.

[603]–[604] *DIL 1:N Extension and Delayed Ringing — Day/Night*

Assigns the ringing extensions and the notification method in the day or night mode for each ISDN port which is assigned to the Direct In Lines (DIL) 1:N function.

| | | | | | | |
|----------|----------|----------|----------------|---------------|-----------------|----------|
| 6 | 0 | X | extension no.* | ISDN port no. | Y | # |
| | | (3...4) | | (1...2,*) | (0, 1, 3, 6, 9) | |

- X** – Program address selection number: 3 ([603] for day) / 4 ([604] for night)
Y – Delayed ringing selection number: 0 (Immediate ringing) / 1 (1 ring delay) / 3 (3 ring delay) / 6 (6 ring delay) / 9 (Disable)
 * Extension number: 21 through 28, 31 through 34 (standard extension) / *

 **DEFAULT** All extensions – All ISDN ports – Immediate ringing (in both modes)
CHANGE The Programming Table is on page 3-73.

[605]–[606] *Outgoing Permitted ISDN Port Assignment — Day/Night*

Determines which ISDN port can be accessed by an extension in both the day and night modes.

| | | | | | | |
|----------|----------|----------|----------------|---------------|----------|----------|
| 6 | 0 | X | extension no.* | ISDN port no. | Y | # |
| | | (5...6) | | (1...2,*) | (1...2) | |

- X** – Program address selection number: 5 ([605] for day) / 6 ([606] for night)
Y – Selection number: 1 (Enable) / 2 (Disable)
 * Extension number: 21 through 28, 31 through 34 (standard extension) / 30 (all ISDN extensions) / *

 **DEFAULT** All extensions – All ISDN ports – Enable (in both modes)
CHANGE The Programming Table is on page 3-73.

[607]–[608] *Doorphone Ringing Assignment — Day/Night*

Assigns which extensions will ring when a doorphone call is received during the day and night modes.

| | | | | | |
|----------|----------|----------|----------------|----------|----------|
| 6 | 0 | X | extension no.* | Y | # |
| | | (7...8) | | (1...2) | |

- X** – Program address selection number: 7 ([607] for day) / 8 ([608] for night)
Y – Selection number: 1 (Enable) / 2 (Disable)
 * Extension number: 21 through 28, 31 through 34 (standard extension) / *

 **DEFAULT** Extension 21 – Enable (in both modes) / Other extensions – Disable (in both modes)
CHANGE The Programming Table is on page 3-73.

[609] *Extension Connection Assignment*

Assigns whether the extension can perform all accesses or not. The extension of jack number 1 should be set to “Connect”.

(1...2)

X – Selection number: 1 (Connect) / 2 (Not connect)

* Extension number: 22 through 28, 31 through 34 (standard extension) / *

DEFAULT All extensions – Connect

CHANGE The Programming Table is on page 3-74.

**[610] *IRNA Assignment***

Enables or disables Intercept Routing – No Answer (IRNA) on an extension basis.

(1...2)

X – Selection number: 1 (Enable) / 2 (Disable)

* Extension number: 21 through 28, 31 through 34 (standard extension) /
30 (all ISDN extensions) / *

DEFAULT All extensions – Enable

CHANGE The Programming Table is on page 3-74.

**[611] *TAM Connection Assignment***

Assigns which extensions are connected to TAMs.

(1...2)

X – Selection number: 1 (Enable) / 2 (Disable)

* Extension number: 21 through 28, 31 through 34 (standard extension) / *

DEFAULT All extensions – Disable

CHANGE The Programming Table is on page 3-74.



[612] Data Line Security

Enables or disables the Data Line Security mode on an extension basis.

6 **1** **2** **extension no.*** **X** **#**
(1...2)

X – Selection number: 1 (Enable) / 2 (Disable)

* Extension number: 21 through 28, 31 through 34 (standard extension) / *



DEFAULT All extensions – Disable

CHANGE The Programming Table is on page 3-74.

[613] Department Codes

Assigns the department codes. To delete the current entry, press # after entering the extension number.

6 **1** **3** **extension no.*** **department no.** **#**
5 digits max. (0...9)

* Extension number: 21 through 28, 31 through 34 (standard extension)
30 (all ISDN extensions) / *



DEFAULT All extensions – Not stored.

CHANGE The Programming Table is on page 3-74.

[614]–[615] Doorphone Call Forwarding – Day/Night

Assigns the destination phone number to the system for forwarding an incoming doorphone call. To delete the current entry, press # after entering the programming address.

6 **1** **X** **ISDN port access code (9, 81, 82) + destination phone no.** **#**
(4, 5) (20 digits max. 0...9, *)

X – Program address selection number: 4 ([614] for day) / 5 ([615] for night)



- Enter “* *” for a PAUSE. The PAUSE is counted as two digits.
- To delete the current entry, press # after entering the programming address.



DEFAULT Not stored.

CHANGE ISDN port access code + destination phone no.
for day _____
for night _____

[700] ARS Mode

Assigns whether each ISDN port can perform the ARS feature or not.

7 **0** **0** **ISDN port no.** **X** **#**
 (1...2,*) (1...2)

X – ARS mode selection number: 1 (Enable) / 2 (Disable)



DEFAULT Both ISDN ports – Disable
CHANGE Both ISDN ports – Enable
 ISDN Port 1 – Enable, ISDN Port 2 – Disable
 ISDN Port 1 – Disable, ISDN Port 2 – Enable

[701] ARS Carrier Code

Assigns the carrier access code for each route.

7 **0** **1** **route no.** **carrier code** **#**
 (1...4) 10 digits max.
 (0...9, *)



- To delete the current entry, press # after entering the route number.
- Enter * * to pause then send the remaining digits as DTMF.



DEFAULT All routes – Not stored.
CHANGE The Programming Table is on page 3-75.

[702] ARS Route Selection Code

Assigns the area codes for each route.

7 **0** **2** **route no.** **area no.** **area code** **#**
 (1...4) (00...79) 7 digits max.
 (0...9, *)



- To delete the current entry, press # after entering the area number.
- * is used as a wildcard character that stands for any digit in a phone number.



DEFAULT All routes – All area numbers – Not stored.
CHANGE The Programming Table is on pages 3-76 and 3-77.

[703] ARS Authorization Code

Registers the authorization code applied to an ISDN line.

| | | | | | | |
|---|---|---|-------------------------------------|---|--|---|
| 7 | 0 | 3 | route no. <small>(1...4)</small> | ISDN port no. <small>(1...2,*)</small> | authorization code <small>20 digits max. (0...9, *)</small> | # |
|---|---|---|-------------------------------------|---|--|---|



- To delete the current entry, press # after entering the ISDN port number.
- Enter * * to pause then send the remaining digits as DTMF.



DEFAULT All routes – All ISDN ports – Not stored.
CHANGE The Programming Table is on page 3-75.

[704] ARS Itemized Bill Code

Assigns whether to send an itemized code or not.

| | | | | | | |
|---|---|---|-------------------------------------|---|-----------------------------|---|
| 7 | 0 | 4 | route no. <small>(1...4)</small> | ISDN port no. <small>(1...2,*)</small> | X <small>(1...2)</small> | # |
|---|---|---|-------------------------------------|---|-----------------------------|---|

X – Itemized bill code selection number: 1 (send) / 2 (Not send)



DEFAULT All routes – All ISDN ports – Not send.
CHANGE The Programming Table is on page 3-75.

[705] 1st Carrier Access Code

Stores the 1st Carrier access code.

| | | | | |
|---|---|---|---|---|
| 7 | 0 | 5 | 1st Carrier access code <small>5 digits max. (0...9)</small> | # |
|---|---|---|---|---|



- To delete the current entry, press # after entering the programming address.



DEFAULT Not stored.
CHANGE _____

[706] ARS Route Exceptional Code

Assigns dialling numbers that are excepted from ARS routing plans of the specified carrier.

| | | | | | | |
|----------|----------|----------|------------------|-----------------|-----------------------------|----------|
| 7 | 0 | 6 | route no. | area no. | excepted code | # |
| | | | (1...4) | (00...79) | 7 digits max. (0...9, *) | |



- To delete the current entry, press # after entering the area number.
- * is used as a wildcard character that stands for any digit in a phone number.



DEFAULT All routes – All area numbers – Not stored.
CHANGE The Programming Table is on pages 3-78 and 3-79.

[708] ARS Modify Removed Digit

Determines how the dialled number should be modified before sending to the exchange line. The digits are deleted from the beginning of the dialled number.

| | | | | | |
|----------|----------|----------|------------------|---------------------------------------|----------|
| 7 | 0 | 8 | route no. | number of digits to be deleted | # |
| | | | (1...4) | (0...9) | |



- Only the numbers assigned in [702] can be deleted even if you assign more digits than these numbers in [708].



DEFAULT All routes – 0 digit (no deletion)
CHANGE The Programming Table is on page 3-75.

[709] ARS Modify Added Number

Determines how the dialled number should be modified before sending to the exchange line. Numbers are added to the beginning of the dialled number.

| | | | | | |
|----------|----------|----------|------------------|----------------------------|----------|
| 7 | 0 | 9 | route no. | number to be added | # |
| | | | (1...4) | (0...9, 20 digits maximum) | |



- To delete the current entry, press # after entering the route number.
- The ARS Modify Added Number will be added to the number after deleting the digits assigned in programming [708] “ARS Modify Removed Digit”.



DEFAULT All routes – Not stored.
CHANGE The Programming Table is on page 3-75.

[800] SMDR Incoming/Outgoing Call Log Printout

Determines which calls will produce an SMDR printout.

8 **0** **0** **X** **Y** **#**
 (1...3) (1...2)

X – Selection number for Outgoing calls: 1 (All calls) / 2 (Toll calls only) / 3 (No printing)

Y – Selection number for Incoming calls: 1 (All calls) / 2 (No printing)



- If “Toll calls only” is selected, the system will print out all of the calls starting from the numbers stored in programs [300]–[304] “TRS Denied Code Entry for Levels 2 through 6”.



DEFAULT Outgoing calls / Incoming calls – No printing

CHANGE Outgoing calls – All calls Toll calls only No printing
 Incoming calls – All calls No printing

[801] SMDR Format

Used to match the SMDR output with the paper size being used in the printer. Page length determines the number of lines per page. Skip perforation determines the number of lines to be skipped at the end of every page.

8 **0** **1** **page length** **skip perforation** **#**
 (04...99) (00...95)



- The page length should be at least 4 lines longer than the skip perforation length.
- The programmed format becomes valid only if a Serial Interface (RS-232C) cable is connected. If a printer is already connected, disconnect it and connect again. Otherwise, the previous format becomes valid.



DEFAULT Page length – 66 lines / Skip perforation – 0 line

CHANGE Page length – _____ lines / Skip perforation – _____ lines

[802] System Data Printout

Starts or stops printing all of the current system-programmed data.

8 **0** **2** **X** **#**
 (1...2)

X – Selection number: 1 (Start) / 2 (Stop)

[803] Music Source Use

Assigns the music source to be used for Music on Hold and Background Music (BGM).

8 **0** **3** **X** **Y** **#**
 (1...2) (1...2)

X – Selection number for Music on Hold: 1 (Music source) / 2 (No music source)

Y – Selection number for BGM: 1 (Music source) / 2 (No music source)



DEFAULT Both – Music source

CHANGE Both – No music source

Music on Hold – Music source, BGM – No music source

Music on Hold – No music source, BGM – Music source

[804] Serial Interface (RS-232C) Parameters

Assigns the communication parameters for the Serial Interface (RS-232C).

New line code: Selects the code for your printer or personal computer. If your printer or personal computer automatically feeds lines with a carriage return, select “CR”. If not, select “CR+LF”.

Baud rate: The baud rate code indicates the data transmission speed from the system to the printer or personal computer.

Word length: The word length code indicates how many bits compose a character.

Parity: The parity code indicates what type of parity is used to detect an error in the string of bits composing a character. Make an appropriate selection depending on the requirements of your printer or personal computer.

Stop bits: The stop bit code indicates the end of a bit string which composes a character. Select the appropriate value depending on the requirements of your printer or personal computer.

8 **0** **4** **new line code no.*1** **baud rate no.*2** **word length no.*3** **parity no.*4** **stop bit no.*5** **#**
 (1...2) (1...7) (1...2) (1...5) (1...2)

*1 New line code number: 1 (CR+LF) / 2 (CR) (CR=Carriage Return, LF=Line Feed)

*2 Baud rate (baud) number: 1 (150) / 2 (300) / 3 (600) / 4 (1200) / 5 (2400) / 6 (4800) / 7 (9600)

*3 Word length number: 1 (7 bits) / 2 (8 bits)

*4 Parity number: 1 (None) / 2 (Mark) / 3 (Space) / 4 (Even) / 5 (Odd)

*5 Stop bit number: 1 (1 bit) / 2 (2 bits)



• The following combinations are invalid.

| Parity | Word Length | Stop Bit |
|--------|-------------|----------|
| Mark | 8 | 2 |
| Space | 8 | 1 |
| Space | 8 | 2 |

DEFAULT New line code – CR+LF / Baud rate – 9600 baud / Word length – 8 bits / Parity – None / Stop bits – 1 bit



CHANGE New line code – _____ / Baud rate – _____ baud / Word length – _____ bits / Parity – _____ / Stop bits – _____ bits

[900] *System Data All Clear*

Clears all of the current system-programmed data. This program causes the system to terminate all calls or programs in progress.

9 **0** **0** **#**

[901] *System Data Clear Except ISDN Data*

Clears all of the current system-programmed data except the ISDN data.

Data which will not be cleared is as follows:

- a) Station Speed Dialling Numbers
- b) [001] System Speed Dialling Number Set
- c) [404] CLIP/COLP Number Assignment
- d) [405] Direct Dialling In
- e) [406] ISDN Configuration
- f) [407] Multiple Subscriber Number Set
- g) [412] ISDN DDI Number/Extension Number Transformation

This program causes the system to terminate all calls or programs in progress.

9 **0** **1** **#**

[902] *System Additional Information*

Assigns the additional programming items, if required. There are 01 through 15 fields in each Area 1 through 4.

| | | | | | | |
|----------|----------|----------|-----------------------------|-------------------------------|---------------------------------|----------|
| 9 | 0 | 2 | area code (1...4) | field no. (00...15) | selection no* (0...1) | # |
|----------|----------|----------|-----------------------------|-------------------------------|---------------------------------|----------|

* Refer to “**Selection**” shown in the lists.

DEFAULT Refer to “**Default**” shown in the lists.



CHANGE Write the change, if any, into “**Change**” shown in the lists.

Explanation for Area 1

| Field | Description | Selection | Default | Change | Reference |
|-------|---|--|---------|--------|----------------------------|
| 00 | Sound source during transfer. | 0 : ringback tone 1 : call hold tone or hold music | 1 | | Call Transfer to Extension |
| 01 | Result of pressing the Recall button and then replacing the handset (during an outside call). | 0 : Consultation hold 1 : disconnect | 0 | | Call Hold |
| 03-02 | Unused | | | | |
| 04 | Selects the destination when the DDI number does not match. | 0 : DIL 1:N 1 : Manager | 1 | | Direct Dialling In (DDI) |
| 15-05 | Unused | | | | |

(Continued)

Explanation for Area 2

| Field | Description | Selection | Default | Change | Reference |
|-------|---|---|---------|--------|---|
| 00 | If an outside party is transferred and unanswered, assigns whether Transfer Recall occurs at the originating transfer extension or the manager. | 0 : extension 1 : manager | 0 | | <ul style="list-style-type: none"> • Call Transfer to Extension • Call Park |
| 01 | Unused | | | | |
| 02 | Allows you to remove confirmation tone 4. By default, a beep tone sounds when a three-party conference is started / ended. | 0 : disable 1 : enable | 1 | | Confirmation Tone |
| 03 | Determines if the dialled “*” and “#” will be checked by Toll Restriction. This assignment is required for certain central offices (CO) to prevent toll fraud. Some CO’s ignore the user-dialled “*” and “#”. If your CO is such a type, select “0” (no check). | 0 : no check 1 : check | 1 | | Toll Restriction |
| 04 | Unused | | | | |
| 05 | Allows you to remove Confirmation Tone 3. This tone is sent when a conversation is established just after dialling the feature numbers to access the following: Call Pickup, Hold Retrieve and Call Park Retrieve. | 0 : disable 1 : enable | 1 | | Confirmation Tone |
| 07-06 | Unused | | | | |
| 08 | Assigns the initial display of the digital large display proprietary telephone (KX-T7235) for Station Speed Dialling. | 0 : names 1 : numbers | 0 | | Display Operation with the KX-T7235 |
| 11-09 | Unused | | | | |
| 12 | Selects the intercom dial tone frequency. To make this assignment effective, you must press the system reset switch after programming. | 0 : normal 1 : distinctive | 0 | | None |
| 13 | Selects the maximum extension - hooking signal detection time. | 0 : ~ 1012ms 1 : ~ 140ms | 0 | | None |
| 14 | Selects the minimum extension - hooking signal detection time. | 0 : 80ms ~ 1 : 116ms ~ | 0 | | None |
| 15 | Unused | | | | |

Explanation for Area 3

| Field | Description | Selection | Default | Change | Reference |
|-------|--|---|---------|--------|--|
| 01-00 | Unused | | | | |
| 02 | Assigns if pressing the HOLD button twice acts as an Exclusive Hold or Hold Retrieve. | 0 : Hold Retrieve 1 : Exclusive Hold | 1 | | <ul style="list-style-type: none"> • Call Hold • Call Hold, Retrieve |
| 03 | Selects the first information to appear on the display while receiving an incoming call (Ext. 21). | 0 : Other party's CLIP no. and name 1 : Called party's no. and name | 0 | | <ul style="list-style-type: none"> • Caller Identification Services |
| 04 | Selects the first information to appear on the display while receiving an incoming call (Ext. 22). | 0 : Other party's CLIP no. and name 1 : Called party's no. and name | 0 | | |
| 05 | Selects the first information to appear on the display while receiving an incoming call (Ext. 23). | 0 : Other party's CLIP no. and name 1 : Called party's no. and name | 0 | | |
| 06 | Selects the first information to appear on the display while receiving an incoming call (Ext. 24). | 0 : Other party's CLIP no. and name 1 : Called party's no. and name | 0 | | |
| 09-07 | Selects the currency unit. | 000 : Polish (ZL) 001 : Hungarian* (Ft) 010 : Czech (Kc) 011 : Slovenian (KM) 100 : Yugoslavian (DI) 101 : Croatian (kn) 110, 111 : Not Stored | 000 | | None |
| 11-10 | Unused | | | | |
| 12 | Selects whether a tone or internal music is used for music on hold. | 0 : tone 1 : music | 0 | | |
| 13 | Unused | | | | |
| 14 | Changes all ROT into BT | 0 : ROT into ROT 1 : ROT into BT | 0 | | None |
| 15 | Unused | | | | |

*If the Hungarian currency is selected;

| field | 09 | 08 | 07 |
|--------|----|----|----|
| Area 3 | 0 | 0 | 1 |

Explanation for Area 4

| Field | Description | Selection | Default | Change | Reference |
|-------|---|---|---------|--------|--------------------------|
| 04-00 | Unused | | | | |
| 05 | Selects the destination during the night mode, when the operator number is sent as a Direct Dialling In number. | 0 : DIL 1:N 1 : Operator | 1 | | Direct Dialling In (DDI) |
| 06 | Selects the destination during the day mode, when the operator number is sent as a Direct Dialling In number. | 0 : DIL 1:N 1 : Operator | 1 | | Direct Dialling In (DDI) |
| 09-08 | Unused | | | | |
| 10 | Assigns whether the system displays the secret dial number or not. | 0 : do not display 1 : display | 0 | | None |
| 15-11 | Unused | | | | |

[903] *Received Number Check*

Indicates the number of the last outside incoming call which was transmitted from the ISDN network on PC or on the display of the PT.

9 **0** **3** **X** **#**
(1...2)

X – Selection number: 1 (indicates the leading 16 digits) / 2 (indicates from 17th to 20th digit)



- You can also check this number by PC.
 - Starts PC programming on PC.
 - Selects “Received Number Check”.

3.13 *PC Programming*

You can program the system data using the special application software which is available for the IBM-PC AT or compatible personal computer. The system programming data can be stored either on the floppy disk or on your hard disk.

To set up for PC programming, you must have MS-DOS (or equivalent) version 5.0 or later. A minimum of 450KB of free conventional memory is required.

File Configuration

The file name: TD208.EXE (Execution file)

You may store the following files if desired.

Database file: *.DBE

ASCII file: *.DBA

Screen save file: P208.PRT



- Substitute your file name with the * mark.

Setup

- (1) Insert the floppy disk into drive A.
- (2) Change the current directory to drive A.
- (3) Type **TD208** after confirming the sign ">" and press the **Enter** key.
 - The initial screen appears.



- After the initial screen appears, you can remove the included disk and insert a database file disk to save the data.
- If your monitor is monochrome and you cannot see a cursor well, exit the program mode and re-type **TD208/MONO**.
- If you need an explanation of the system and its operations, press F4 (Help) on the initial screen.
- This program is guaranteed to work with MS-DOS only. It is not guaranteed with MS-DOS in Windows.



- Connecting the Printer and PC (Section 4.15)

3.14 Programming Tables

| [001] System Speed Dialling Number Set | | | |
|--|-----------------------------------|---------|-----------------------------------|
| Default: All – Not Stored | | | |
| SPD No. | Telephone Number (24 digits max.) | SPD No. | Telephone Number (24 digits max.) |
| 00 | | 40 | |
| 01 | | 41 | |
| 02 | | 42 | |
| 03 | | 43 | |
| 04 | | 44 | |
| 05 | | 45 | |
| 06 | | 46 | |
| 07 | | 47 | |
| 08 | | 48 | |
| 09 | | 49 | |
| 10 | | 50 | |
| 11 | | 51 | |
| 12 | | 52 | |
| 13 | | 53 | |
| 14 | | 54 | |
| 15 | | 55 | |
| 16 | | 56 | |
| 17 | | 57 | |
| 18 | | 58 | |
| 19 | | 59 | |
| 20 | | 60 | |
| 21 | | 61 | |
| 22 | | 62 | |
| 23 | | 63 | |
| 24 | | 64 | |
| 25 | | 65 | |
| 26 | | 66 | |
| 27 | | 67 | |
| 28 | | 68 | |
| 29 | | 69 | |
| 30 | | 70 | |
| 31 | | 71 | |
| 32 | | 72 | |
| 33 | | 73 | |
| 34 | | 74 | |
| 35 | | 75 | |
| 36 | | 76 | |
| 37 | | 77 | |
| 38 | | 78 | |
| 39 | | 79 | |

3.14 Programming Tables

| [001] System Speed Dialling Number Set | | | |
|--|-----------------------------------|---------|-----------------------------------|
| SPD No. | Telephone Number (24 digits max.) | SPD No. | Telephone Number (24 digits max.) |
| 80 | | 90 | |
| 81 | | 91 | |
| 82 | | 92 | |
| 83 | | 93 | |
| 84 | | 94 | |
| 85 | | 95 | |
| 86 | | 96 | |
| 87 | | 97 | |
| 88 | | 98 | |
| 89 | | 99 | |

| [003] Budget Management | | [101] Account Codes | | | | | |
|-------------------------|------------------------------|----------------------------|------------------------------|--------------|------------------------------|--------------|------------------------------|
| Default : all – 0 | | Default : all – Not Stored | | | | | |
| Extension No. | Charge Limitation (0...9999) | Location No. | Account Code (5 digits max.) | Location No. | Account Code (5 digits max.) | Location No. | Account Code (5 digits max.) |
| All extensions | 0 | 01 | | 15 | | 29 | |
| Ext. 21 | | 02 | | 16 | | 30 | |
| 22 | | 03 | | 17 | | 31 | |
| 23 | | 04 | | 18 | | 32 | |
| 24 | | 05 | | 19 | | 33 | |
| 25 | | 06 | | 20 | | 34 | |
| 26 | | 07 | | 21 | | 35 | |
| 27 | | 08 | | 22 | | 36 | |
| 28 | | 09 | | 23 | | 37 | |
| 31 | | 10 | | 24 | | 38 | |
| 32 | | 11 | | 25 | | 39 | |
| 33 | | 12 | | 26 | | 40 | |
| 34 | | 13 | | 27 | | | |
| ISDN extensions | | 14 | | 28 | | | |

| [102] Station Hunting Type | | | | | | | | | | |
|----------------------------|---------|---|---|---|---|---|---|---|---|---|
| | Default | Extension group number (1...8, * : all) | | | | | | | | |
| | All | 1 | 2 | 3 | 4 | 5 | 6 | 7 | 8 | * |
| 1 (No hunting) | ✓ | | | | | | | | | |
| 2 (Termination) | | | | | | | | | | |
| 3 (Circular) | | | | | | | | | | |
| 4 (UCD) | | | | | | | | | | |
| 5 (Ring Group) | | | | | | | | | | |

3.14 Programming Tables

| | [300] TRS Denied Code Entry for Levels 2 – 6 | [301] TRS Denied Code Entry for Levels 3 – 6 | [302] TRS Denied Code Entry for Levels 4 – 6 | [303] TRS Denied Code Entry for Levels 5 – 6 | [304] TRS Denied Code Entry for Level 6 |
|--------------|---|---|---|---|--|
| Location No. | TRS Denied Code (7 digits max.) | | | | |
| Default | All: Not Stored | | | | |
| 01 | | | | | |
| 02 | | | | | |
| 03 | | | | | |
| 04 | | | | | |
| 05 | | | | | |
| 06 | | | | | |
| 07 | | | | | |
| 08 | | | | | |
| 09 | | | | | |
| 10 | | | | | |
| 11 | | | | | |
| 12 | | | | | |
| 13 | | | | | |
| 14 | | | | | |
| 15 | | | | | |
| 16 | | | | | |
| 17 | | | | | |
| 18 | | | | | |
| 19 | | | | | |
| 20 | | | | | |

| | [400] ISDN Port Connection Assignment | | [401] Intercept Extension — Day | | [402] Intercept Extension — Night | |
|----------------|---|-------------|------------------------------------|---------------|--------------------------------------|---------------|
| ISDN Port No. | Connect | Not Connect | Disable | Extension No. | Disable | Extension No. |
| Default : all | ✓ | | ✓ | | ✓ | |
| All ISDN ports | | | | | | |
| ISDN Port 1 | | | | | | |
| 2 | | | | | | |

| | [403] Host PBX Access Codes | | | [405] Direct Dialling In | | [406] ISDN Configuration | | | |
|----------------|--------------------------------|--|--|-----------------------------|---------|-----------------------------|-----|----------------|-----|
| ISDN Port No. | Access Code (1 or 2 digits) | | | Enable | Disable | Outside line (CO) | | Extension line | |
| | | | | | | P-MP | P-P | P-MP | P-P |
| Default : all | Not Stored | | | ✓ | | ✓ | | | |
| All ISDN ports | | | | | | | | | |
| ISDN Port 1 | | | | | | | | | |
| 2 | | | | | | | | | |

<Note> P-MP : Point-to-multi-point P-P : Point-to-point

3.14 Programming Tables

| | [305] TRS Excepted Code Entry for Level 2 | [306] TRS Excepted Code Entry for Levels 2 – 3 | [307] TRS Excepted Code Entry for Levels 2 – 4 | [308] TRS Excepted Code Entry for Levels 2 – 5 | [309] TRS Excepted Code Entry for Levels 2 – 6 |
|--------------|--|---|---|---|---|
| Location No. | Excepted Code (7 digits max.) | | | | |
| Default | All: Not Stored | | | | |
| 01 | | | | | |
| 02 | | | | | |
| 03 | | | | | |
| 04 | | | | | |
| 05 | | | | | |
| 06 | | | | | |
| 07 | | | | | |
| 08 | | | | | |
| 09 | | | | | |
| 10 | | | | | |
| 11 | | | | | |
| 12 | | | | | |
| 13 | | | | | |
| 14 | | | | | |
| 15 | | | | | |
| 16 | | | | | |
| 17 | | | | | |
| 18 | | | | | |
| 19 | | | | | |
| 20 | | | | | |

| [404] CLIP/COLP Number Assignment | | | | | |
|-----------------------------------|--|--------|-----------|--|--------|
| Default: all | Not Stored | | | | |
| | All CLIP/COLP no. (Business and Private) | | | All CLIP/COLP no. (Business and Private) | |
| | Port 1 | Port 2 | | Port 1 | Port 2 |
| Ext. 21 | | | Ext. 34 | | |
| 22 | | | 300 or 30 | | |
| 23 | | | 301 | | |
| 24 | | | 302 | | |
| 25 | | | 303 | | |
| 26 | | | 304 | | |
| 27 | | | 305 | | |
| 28 | | | 306 | | |
| 31 | | | 307 | | |
| 32 | | | 308 | | |
| 33 | | | | | |

3.14 Programming Tables

| [404] CLIP/COLP Number Assignment | | | | |
|-----------------------------------|---------------------|--------|--------------------|--------|
| Default : all | Not Stored | | | |
| | CLIP no. (Business) | | CLIP no. (Private) | |
| | Port 1 | Port 2 | Port 1 | Port 2 |
| Ext. 21 | | | | |
| 22 | | | | |
| 23 | | | | |
| 24 | | | | |
| 25 | | | | |
| 26 | | | | |
| 27 | | | | |
| 28 | | | | |
| 31 | | | | |
| 32 | | | | |
| 33 | | | | |
| 34 | | | | |
| 300 or 30 | | | | |
| 301 | | | | |
| 302 | | | | |
| 303 | | | | |
| 304 | | | | |
| 305 | | | | |
| 306 | | | | |
| 307 | | | | |
| 308 | | | | |

| [407] Multiple Subscriber Number Set | | | |
|--------------------------------------|----------------------------|-------------|-------------|
| MSN Loc. No. | MSN No. (16 digits max.) | | |
| | Default : All – Not Stored | | |
| | All ISDN ports | ISDN Port 1 | ISDN Port 2 |
| 01 | | | |
| 02 | | | |
| 03 | | | |
| 04 | | | |
| 05 | | | |
| 06 | | | |
| 07 | | | |
| 08 | | | |
| 09 | | | |
| 10 | | | |

3.14 Programming Tables

| [404] CLIP/COLP Number Assignment | | | | | |
|-----------------------------------|--|---------------------|--------|--------------------|--------|
| Default : all | | Not Stored | | | |
| | | COLP no. (Business) | | COLP no. (Private) | |
| | | Port 1 | Port 2 | Port 1 | Port 2 |
| Ext. 21 | | | | | |
| 22 | | | | | |
| 23 | | | | | |
| 24 | | | | | |
| 25 | | | | | |
| 26 | | | | | |
| 27 | | | | | |
| 28 | | | | | |
| 31 | | | | | |
| 32 | | | | | |
| 33 | | | | | |
| 34 | | | | | |
| 300 or 30 | | | | | |
| 301 | | | | | |
| 302 | | | | | |
| 303 | | | | | |
| 304 | | | | | |
| 305 | | | | | |
| 306 | | | | | |
| 307 | | | | | |
| 308 | | | | | |

| | | [408] Extension Ringing Assignment – Day for ISDN | | | | | | [409] Extension Ringing Assignment – Night for ISDN | | | | | | | | | | | | | | | | | | | | | | | |
|--------------|---------------|--|---|---|-------------|---|---|--|---|---|----------------|---|---|-------------|---|---|-------------|---|---|---|---|---|---|---|---|---|---|--|--|--|--|
| MSN Loc. No. | Extension No. | All ISDN ports | | | ISDN port 1 | | | ISDN port 2 | | | All ISDN ports | | | ISDN port 1 | | | ISDN port 2 | | | | | | | | | | | | | | |
| | | 0 | 1 | 3 | 6 | 9 | 0 | 1 | 3 | 6 | 9 | 0 | 1 | 3 | 6 | 9 | 0 | 1 | 3 | 6 | 9 | 0 | 1 | 3 | 6 | 9 | | | | | |
| Default: all | | ✓ | | | | | ✓ | | | | | ✓ | | | | | ✓ | | | | | ✓ | | | | | ✓ | | | | |
| 01 | All exts | | | | | | | | | | | | | | | | | | | | | | | | | | | | | | |
| | Ext. 21 | | | | | | | | | | | | | | | | | | | | | | | | | | | | | | |
| | 22 | | | | | | | | | | | | | | | | | | | | | | | | | | | | | | |
| | 23 | | | | | | | | | | | | | | | | | | | | | | | | | | | | | | |
| | 24 | | | | | | | | | | | | | | | | | | | | | | | | | | | | | | |
| | 25 | | | | | | | | | | | | | | | | | | | | | | | | | | | | | | |
| | 26 | | | | | | | | | | | | | | | | | | | | | | | | | | | | | | |
| | 27 | | | | | | | | | | | | | | | | | | | | | | | | | | | | | | |
| | 28 | | | | | | | | | | | | | | | | | | | | | | | | | | | | | | |
| | 31 | | | | | | | | | | | | | | | | | | | | | | | | | | | | | | |
| | 32 | | | | | | | | | | | | | | | | | | | | | | | | | | | | | | |
| 33 | | | | | | | | | | | | | | | | | | | | | | | | | | | | | | | |
| 34 | | | | | | | | | | | | | | | | | | | | | | | | | | | | | | | |

<Note> 0 : Immediate, 1 : 1 ring delay, 3 : 3 ring delay, 6 : 6 ring delay, 9 : disable

3.14 Programming Tables

| | | [408] Extension Ringing Assignment – Day for ISDN | | | | | | | | | [409] Extension Ringing Assignment – Night for ISDN | | | | | | | | | | | | | | | | | | | | | | | | | |
|-----------------|------------------|--|---|---|---|---|-------------|---|---|---|--|---|---|---|----------------|---|---|---|---|-------------|---|---|---|-------------|---|---|---|---|---|---|---|---|---|---|---|---|
| | | All ISDN ports | | | | | ISDN port 1 | | | | ISDN port 2 | | | | All ISDN ports | | | | | ISDN port 1 | | | | ISDN port 2 | | | | | | | | | | | | |
| MSN Loc. No. | Extension No. | 0 | 1 | 3 | 6 | 9 | 0 | 1 | 3 | 6 | 9 | 0 | 1 | 3 | 6 | 9 | 0 | 1 | 3 | 6 | 9 | 0 | 1 | 3 | 6 | 9 | 0 | 1 | 3 | 6 | 9 | 0 | 1 | 3 | 6 | 9 |
| Default: all | | ✓ | | | | | ✓ | | | | | ✓ | | | | | ✓ | | | | | ✓ | | | | | ✓ | | | | | ✓ | | | | |
| 02 | All exts | | | | | | | | | | | | | | | | | | | | | | | | | | | | | | | | | | | |
| | Ext. 21 | | | | | | | | | | | | | | | | | | | | | | | | | | | | | | | | | | | |
| | 22 | | | | | | | | | | | | | | | | | | | | | | | | | | | | | | | | | | | |
| | 23 | | | | | | | | | | | | | | | | | | | | | | | | | | | | | | | | | | | |
| | 24 | | | | | | | | | | | | | | | | | | | | | | | | | | | | | | | | | | | |
| | 25 | | | | | | | | | | | | | | | | | | | | | | | | | | | | | | | | | | | |
| | 26 | | | | | | | | | | | | | | | | | | | | | | | | | | | | | | | | | | | |
| | 27 | | | | | | | | | | | | | | | | | | | | | | | | | | | | | | | | | | | |
| | 28 | | | | | | | | | | | | | | | | | | | | | | | | | | | | | | | | | | | |
| | 31 | | | | | | | | | | | | | | | | | | | | | | | | | | | | | | | | | | | |
| | 32 | | | | | | | | | | | | | | | | | | | | | | | | | | | | | | | | | | | |
| | 33 | | | | | | | | | | | | | | | | | | | | | | | | | | | | | | | | | | | |
| 34 | | | | | | | | | | | | | | | | | | | | | | | | | | | | | | | | | | | | |
| 03 | All exts | | | | | | | | | | | | | | | | | | | | | | | | | | | | | | | | | | | |
| | Ext. 21 | | | | | | | | | | | | | | | | | | | | | | | | | | | | | | | | | | | |
| | 22 | | | | | | | | | | | | | | | | | | | | | | | | | | | | | | | | | | | |
| | 23 | | | | | | | | | | | | | | | | | | | | | | | | | | | | | | | | | | | |
| | 24 | | | | | | | | | | | | | | | | | | | | | | | | | | | | | | | | | | | |
| | 25 | | | | | | | | | | | | | | | | | | | | | | | | | | | | | | | | | | | |
| | 26 | | | | | | | | | | | | | | | | | | | | | | | | | | | | | | | | | | | |
| | 27 | | | | | | | | | | | | | | | | | | | | | | | | | | | | | | | | | | | |
| | 28 | | | | | | | | | | | | | | | | | | | | | | | | | | | | | | | | | | | |
| | 31 | | | | | | | | | | | | | | | | | | | | | | | | | | | | | | | | | | | |
| | 32 | | | | | | | | | | | | | | | | | | | | | | | | | | | | | | | | | | | |
| | 33 | | | | | | | | | | | | | | | | | | | | | | | | | | | | | | | | | | | |
| 34 | | | | | | | | | | | | | | | | | | | | | | | | | | | | | | | | | | | | |
| 04 | All exts | | | | | | | | | | | | | | | | | | | | | | | | | | | | | | | | | | | |
| | Ext. 21 | | | | | | | | | | | | | | | | | | | | | | | | | | | | | | | | | | | |
| | 22 | | | | | | | | | | | | | | | | | | | | | | | | | | | | | | | | | | | |
| | 23 | | | | | | | | | | | | | | | | | | | | | | | | | | | | | | | | | | | |
| | 24 | | | | | | | | | | | | | | | | | | | | | | | | | | | | | | | | | | | |
| | 25 | | | | | | | | | | | | | | | | | | | | | | | | | | | | | | | | | | | |
| | 26 | | | | | | | | | | | | | | | | | | | | | | | | | | | | | | | | | | | |
| | 27 | | | | | | | | | | | | | | | | | | | | | | | | | | | | | | | | | | | |
| | 28 | | | | | | | | | | | | | | | | | | | | | | | | | | | | | | | | | | | |
| | 31 | | | | | | | | | | | | | | | | | | | | | | | | | | | | | | | | | | | |
| | 32 | | | | | | | | | | | | | | | | | | | | | | | | | | | | | | | | | | | |
| | 33 | | | | | | | | | | | | | | | | | | | | | | | | | | | | | | | | | | | |
| 34 | | | | | | | | | | | | | | | | | | | | | | | | | | | | | | | | | | | | |

<Note> 0 : Immediate, 1 : 1 ring delay, 3 : 3 ring delay, 6 : 6 ring delay, 9 : disable

3.14 Programming Tables

| | | [408] Extension Ringing Assignment – Day for ISDN | | | | | | | | | [409] Extension Ringing Assignment – Night for ISDN | | | | | | | | | | | | | | | | | | | | | | | | | |
|-----------------|------------------|--|---|---|---|---|-------------|---|---|---|--|---|---|---|----------------|---|---|---|---|-------------|---|---|---|-------------|---|---|---|---|---|---|---|---|--|--|--|--|
| | | All ISDN ports | | | | | ISDN port 1 | | | | ISDN port 2 | | | | All ISDN ports | | | | | ISDN port 1 | | | | ISDN port 2 | | | | | | | | | | | | |
| MSN Loc. No. | Extension No. | 0 | 1 | 3 | 6 | 9 | 0 | 1 | 3 | 6 | 9 | 0 | 1 | 3 | 6 | 9 | 0 | 1 | 3 | 6 | 9 | 0 | 1 | 3 | 6 | 9 | 0 | 1 | 3 | 6 | 9 | | | | | |
| | Default: all | ✓ | | | | | ✓ | | | | | ✓ | | | | | ✓ | | | | | ✓ | | | | | ✓ | | | | | ✓ | | | | |
| 05 | All exts | | | | | | | | | | | | | | | | | | | | | | | | | | | | | | | | | | | |
| | Ext. 21 | | | | | | | | | | | | | | | | | | | | | | | | | | | | | | | | | | | |
| | 22 | | | | | | | | | | | | | | | | | | | | | | | | | | | | | | | | | | | |
| | 23 | | | | | | | | | | | | | | | | | | | | | | | | | | | | | | | | | | | |
| | 24 | | | | | | | | | | | | | | | | | | | | | | | | | | | | | | | | | | | |
| | 25 | | | | | | | | | | | | | | | | | | | | | | | | | | | | | | | | | | | |
| | 26 | | | | | | | | | | | | | | | | | | | | | | | | | | | | | | | | | | | |
| | 27 | | | | | | | | | | | | | | | | | | | | | | | | | | | | | | | | | | | |
| | 28 | | | | | | | | | | | | | | | | | | | | | | | | | | | | | | | | | | | |
| | 31 | | | | | | | | | | | | | | | | | | | | | | | | | | | | | | | | | | | |
| | 32 | | | | | | | | | | | | | | | | | | | | | | | | | | | | | | | | | | | |
| | 33 | | | | | | | | | | | | | | | | | | | | | | | | | | | | | | | | | | | |
| 34 | | | | | | | | | | | | | | | | | | | | | | | | | | | | | | | | | | | | |
| 06 | All exts | | | | | | | | | | | | | | | | | | | | | | | | | | | | | | | | | | | |
| | Ext. 21 | | | | | | | | | | | | | | | | | | | | | | | | | | | | | | | | | | | |
| | 22 | | | | | | | | | | | | | | | | | | | | | | | | | | | | | | | | | | | |
| | 23 | | | | | | | | | | | | | | | | | | | | | | | | | | | | | | | | | | | |
| | 24 | | | | | | | | | | | | | | | | | | | | | | | | | | | | | | | | | | | |
| | 25 | | | | | | | | | | | | | | | | | | | | | | | | | | | | | | | | | | | |
| | 26 | | | | | | | | | | | | | | | | | | | | | | | | | | | | | | | | | | | |
| | 27 | | | | | | | | | | | | | | | | | | | | | | | | | | | | | | | | | | | |
| | 28 | | | | | | | | | | | | | | | | | | | | | | | | | | | | | | | | | | | |
| | 31 | | | | | | | | | | | | | | | | | | | | | | | | | | | | | | | | | | | |
| | 32 | | | | | | | | | | | | | | | | | | | | | | | | | | | | | | | | | | | |
| | 33 | | | | | | | | | | | | | | | | | | | | | | | | | | | | | | | | | | | |
| 34 | | | | | | | | | | | | | | | | | | | | | | | | | | | | | | | | | | | | |
| 07 | All exts | | | | | | | | | | | | | | | | | | | | | | | | | | | | | | | | | | | |
| | Ext. 21 | | | | | | | | | | | | | | | | | | | | | | | | | | | | | | | | | | | |
| | 22 | | | | | | | | | | | | | | | | | | | | | | | | | | | | | | | | | | | |
| | 23 | | | | | | | | | | | | | | | | | | | | | | | | | | | | | | | | | | | |
| | 24 | | | | | | | | | | | | | | | | | | | | | | | | | | | | | | | | | | | |
| | 25 | | | | | | | | | | | | | | | | | | | | | | | | | | | | | | | | | | | |
| | 26 | | | | | | | | | | | | | | | | | | | | | | | | | | | | | | | | | | | |
| | 27 | | | | | | | | | | | | | | | | | | | | | | | | | | | | | | | | | | | |
| | 28 | | | | | | | | | | | | | | | | | | | | | | | | | | | | | | | | | | | |
| | 31 | | | | | | | | | | | | | | | | | | | | | | | | | | | | | | | | | | | |
| | 32 | | | | | | | | | | | | | | | | | | | | | | | | | | | | | | | | | | | |
| | 33 | | | | | | | | | | | | | | | | | | | | | | | | | | | | | | | | | | | |
| 34 | | | | | | | | | | | | | | | | | | | | | | | | | | | | | | | | | | | | |

<Note> 0 : Immediate, 1 : 1 ring delay, 3 : 3 ring delay, 6 : 6 ring delay, 9 : disable

3.14 Programming Tables

| | | [408] Extension Ringing Assignment – Day for ISDN | | | | | | | | | [409] Extension Ringing Assignment – Night for ISDN | | | | | | | | | | | | | | | | | | | | | | | | | |
|--------------|---------------|--|---|---|---|---|-------------|---|---|---|--|---|---|---|----------------|---|---|---|---|-------------|---|---|---|-------------|---|---|---|---|---|---|---|---|---|---|---|---|
| | | All ISDN ports | | | | | ISDN port 1 | | | | ISDN port 2 | | | | All ISDN ports | | | | | ISDN port 1 | | | | ISDN port 2 | | | | | | | | | | | | |
| MSN Loc. No. | Extension No. | 0 | 1 | 3 | 6 | 9 | 0 | 1 | 3 | 6 | 9 | 0 | 1 | 3 | 6 | 9 | 0 | 1 | 3 | 6 | 9 | 0 | 1 | 3 | 6 | 9 | 0 | 1 | 3 | 6 | 9 | 0 | 1 | 3 | 6 | 9 |
| Default: all | | ✓ | | | | | ✓ | | | | | ✓ | | | | | ✓ | | | | | ✓ | | | | | ✓ | | | | | ✓ | | | | |
| 08 | All exts | | | | | | | | | | | | | | | | | | | | | | | | | | | | | | | | | | | |
| | Ext. 21 | | | | | | | | | | | | | | | | | | | | | | | | | | | | | | | | | | | |
| | 22 | | | | | | | | | | | | | | | | | | | | | | | | | | | | | | | | | | | |
| | 23 | | | | | | | | | | | | | | | | | | | | | | | | | | | | | | | | | | | |
| | 24 | | | | | | | | | | | | | | | | | | | | | | | | | | | | | | | | | | | |
| | 25 | | | | | | | | | | | | | | | | | | | | | | | | | | | | | | | | | | | |
| | 26 | | | | | | | | | | | | | | | | | | | | | | | | | | | | | | | | | | | |
| | 27 | | | | | | | | | | | | | | | | | | | | | | | | | | | | | | | | | | | |
| | 28 | | | | | | | | | | | | | | | | | | | | | | | | | | | | | | | | | | | |
| | 31 | | | | | | | | | | | | | | | | | | | | | | | | | | | | | | | | | | | |
| | 32 | | | | | | | | | | | | | | | | | | | | | | | | | | | | | | | | | | | |
| | 33 | | | | | | | | | | | | | | | | | | | | | | | | | | | | | | | | | | | |
| 34 | | | | | | | | | | | | | | | | | | | | | | | | | | | | | | | | | | | | |
| 09 | All exts | | | | | | | | | | | | | | | | | | | | | | | | | | | | | | | | | | | |
| | Ext. 21 | | | | | | | | | | | | | | | | | | | | | | | | | | | | | | | | | | | |
| | 22 | | | | | | | | | | | | | | | | | | | | | | | | | | | | | | | | | | | |
| | 23 | | | | | | | | | | | | | | | | | | | | | | | | | | | | | | | | | | | |
| | 24 | | | | | | | | | | | | | | | | | | | | | | | | | | | | | | | | | | | |
| | 25 | | | | | | | | | | | | | | | | | | | | | | | | | | | | | | | | | | | |
| | 26 | | | | | | | | | | | | | | | | | | | | | | | | | | | | | | | | | | | |
| | 27 | | | | | | | | | | | | | | | | | | | | | | | | | | | | | | | | | | | |
| | 28 | | | | | | | | | | | | | | | | | | | | | | | | | | | | | | | | | | | |
| | 31 | | | | | | | | | | | | | | | | | | | | | | | | | | | | | | | | | | | |
| | 32 | | | | | | | | | | | | | | | | | | | | | | | | | | | | | | | | | | | |
| | 33 | | | | | | | | | | | | | | | | | | | | | | | | | | | | | | | | | | | |
| 34 | | | | | | | | | | | | | | | | | | | | | | | | | | | | | | | | | | | | |
| 10 | All exts | | | | | | | | | | | | | | | | | | | | | | | | | | | | | | | | | | | |
| | Ext. 21 | | | | | | | | | | | | | | | | | | | | | | | | | | | | | | | | | | | |
| | 22 | | | | | | | | | | | | | | | | | | | | | | | | | | | | | | | | | | | |
| | 23 | | | | | | | | | | | | | | | | | | | | | | | | | | | | | | | | | | | |
| | 24 | | | | | | | | | | | | | | | | | | | | | | | | | | | | | | | | | | | |
| | 25 | | | | | | | | | | | | | | | | | | | | | | | | | | | | | | | | | | | |
| | 26 | | | | | | | | | | | | | | | | | | | | | | | | | | | | | | | | | | | |
| | 27 | | | | | | | | | | | | | | | | | | | | | | | | | | | | | | | | | | | |
| | 28 | | | | | | | | | | | | | | | | | | | | | | | | | | | | | | | | | | | |
| | 31 | | | | | | | | | | | | | | | | | | | | | | | | | | | | | | | | | | | |
| | 32 | | | | | | | | | | | | | | | | | | | | | | | | | | | | | | | | | | | |
| | 33 | | | | | | | | | | | | | | | | | | | | | | | | | | | | | | | | | | | |
| 34 | | | | | | | | | | | | | | | | | | | | | | | | | | | | | | | | | | | | |

<Note> 0 : Immediate, 1 : 1 ring delay, 3 : 3 ring delay, 6 : 6 ring delay, 9 : disable

3.14 Programming Tables

| | [410] ISDN Extension Ringing Assignment – Day for ISDN | | | [411] ISDN Extension Ringing Assignment – Night for ISDN | | |
|-----------------|---|-------------|-------------|---|-------------|-------------|
| MSN Loc. No. | ISDN Extension No. (300, 301...308) | | | | | |
| | Default : All – Not Stored | | | | | |
| | All ISDN ports | ISDN Port 1 | ISDN Port 2 | All ISDN ports | ISDN Port 1 | ISDN Port 2 |
| 01 | | | | | | |
| 02 | | | | | | |
| 03 | | | | | | |
| 04 | | | | | | |
| 05 | | | | | | |
| 06 | | | | | | |
| 07 | | | | | | |
| 08 | | | | | | |
| 09 | | | | | | |
| 10 | | | | | | |

3.14 Programming Tables

| [412] ISDN DDI Number/Extension Number Transformation | | |
|---|------------------|------------------|
| Default : all | Not Stored | |
| | DDI no. (Port 1) | DDI no. (Port 2) |
| Ext. 21 | | |
| 22 | | |
| 23 | | |
| 24 | | |
| 25 | | |
| 26 | | |
| 27 | | |
| 28 | | |
| 31 | | |
| 32 | | |
| 33 | | |
| 34 | | |
| 291 | | |
| 292 | | |
| 293 | | |
| 294 | | |
| 295 | | |
| 296 | | |
| 297 | | |
| 298 | | |
| 300 or 30 | | |
| 301 | | |
| 302 | | |
| 303 | | |
| 304 | | |
| 305 | | |
| 306 | | |
| 307 | | |
| 308 | | |

3.14 Programming Tables

| | Selection | Default | COS No. | | | | |
|--|--|---------|---------|-------|-------|-------|-------|
| | | All | All COS | COS 1 | COS 2 | COS 3 | COS 4 |
| [500] Toll Restriction Level – Day | Level 1 | ✓ | | | | | |
| | 2 | | | | | | |
| | 3 | | | | | | |
| | 4 | | | | | | |
| | 5 | | | | | | |
| | 6 | | | | | | |
| | 7 | | | | | | |
| | 8 | | | | | | |
| | [501] Toll Restriction Level – Night | Level 1 | ✓ | | | | |
| 2 | | | | | | | |
| 3 | | | | | | | |
| 4 | | | | | | | |
| 5 | | | | | | | |
| 6 | | | | | | | |
| 7 | | | | | | | |
| 8 | | | | | | | |
| [503] Call Forwarding to Outside Line (CO) | | Enable | ✓ | | | | |
| | Disable | | | | | | |
| [504] Do Not Disturb Override | Enable | | | | | | |
| | Disable | ✓ | | | | | |
| [505] Account Code Entry Mode | Option | ✓ | | | | | |
| | Verify-All | | | | | | |
| | Verify-Toll | | | | | | |
| [506] Toll Restriction Level for System Speed Dialling – Day | Level 1 | ✓ | | | | | |
| | 2 | | | | | | |
| | 3 | | | | | | |
| | 4 | | | | | | |
| | 5 | | | | | | |
| | 6 | | | | | | |
| | 7 | | | | | | |
| | 8 | | | | | | |
| | [507] Toll Restriction Level for System Speed Dialling – Night | Level 1 | ✓ | | | | |
| 2 | | | | | | | |
| 3 | | | | | | | |
| 4 | | | | | | | |
| 5 | | | | | | | |
| 6 | | | | | | | |
| 7 | | | | | | | |
| 8 | | | | | | | |
| [508] Door Opener Access | | Enable | ✓ | | | | |
| | Disable | | | | | | |
| [509] Night Service Access | Enable | ✓ | | | | | |
| | Disable | | | | | | |

3.14 Programming Tables

| | Selection | Default | COS No. | | | | |
|---|-----------|---------|---------|-------|-------|-------|-------|
| | | All | All COS | COS 1 | COS 2 | COS 3 | COS 4 |
| [510] Do Not Disturb for Direct Dialling In Call | Enable | | | | | | |
| | Disable | ✓ | | | | | |
| [511] Call Forwarding – Follow Me | Enable | ✓ | | | | | |
| | Disable | | | | | | |
| [512] Calling Line Identification Restriction (CLIR) | Enable | | | | | | |
| | Disable | ✓ | | | | | |
| [513] Connected Line Identification Restriction (COLR) | Enable | | | | | | |
| | Disable | ✓ | | | | | |
| [514] Executive Busy Override | Enable | | | | | | |
| | Disable | ✓ | | | | | |
| [515] Executive Busy Override Deny | Enable | ✓ | | | | | |
| | Disable | | | | | | |
| [517] Call Forwarding by ISDN Service | Enable | | | | | | |
| | Disable | ✓ | | | | | |

| Extension No. | [600] Extra Device Port | | [601] Class of service | | | | | | | | [602] Extension Group Assignment | | | | | | | | |
|-----------------|--------------------------------|---------|-------------------------------|---|---|---|---------------------------|---|---|---|---|---|---|---|---|---|---|---|--|
| | Enable | Disable | Primary COS No. (1...4) | | | | Secondary COS No. (1...4) | | | | Extension Group No. (1...8) | | | | | | | | |
| | | | 1 | 2 | 3 | 4 | 1 | 2 | 3 | 4 | 1 | 2 | 3 | 4 | 5 | 6 | 7 | 8 | |
| Default : all | | ✓ | ✓ | | | | | ✓ | | | | | | ✓ | | | | | |
| All extensions | | | | | | | | | | | | | | | | | | | |
| Ext. 21 | | | | | | | | | | | | | | | | | | | |
| 22 | | | | | | | | | | | | | | | | | | | |
| 23 | | | | | | | | | | | | | | | | | | | |
| 24 | | | | | | | | | | | | | | | | | | | |
| 25 | | | | | | | | | | | | | | | | | | | |
| 26 | | | | | | | | | | | | | | | | | | | |
| 27 | | | | | | | | | | | | | | | | | | | |
| 28 | | | | | | | | | | | | | | | | | | | |
| 31 | | | | | | | | | | | | | | | | | | | |
| 32 | | | | | | | | | | | | | | | | | | | |
| 33 | | | | | | | | | | | | | | | | | | | |
| 34 | | | | | | | | | | | | | | | | | | | |
| ISDN extensions | | | | | | | | | | | | | | | | | | | |

3.14 Programming Tables

| Extension No. | [603] DIL 1:N Extension and Delayed Ringing – Day | | | | | | | | | [604] DIL 1:N Extension and Delayed Ringing – Night | | | | | | | | | | | | | | | | | | | | |
|---------------|--|---|---|-------------|---|---|-------------|---|---|--|---|---|-------------|---|---|-------------|---|---|---|---|---|---|---|---|---|---|--|--|--|--|
| | All ISDN ports | | | ISDN port 1 | | | ISDN port 2 | | | All ISDN ports | | | ISDN port 1 | | | ISDN port 2 | | | | | | | | | | | | | | |
| | 0 | 1 | 3 | 6 | 9 | 0 | 1 | 3 | 6 | 9 | 0 | 1 | 3 | 6 | 9 | 0 | 1 | 3 | 6 | 9 | 0 | 1 | 3 | 6 | 9 | | | | | |
| Default: all | ✓ | | | | | ✓ | | | | | ✓ | | | | | ✓ | | | | | ✓ | | | | | ✓ | | | | |
| All exts | | | | | | | | | | | | | | | | | | | | | | | | | | | | | | |
| Ext. 21 | | | | | | | | | | | | | | | | | | | | | | | | | | | | | | |
| 22 | | | | | | | | | | | | | | | | | | | | | | | | | | | | | | |
| 23 | | | | | | | | | | | | | | | | | | | | | | | | | | | | | | |
| 24 | | | | | | | | | | | | | | | | | | | | | | | | | | | | | | |
| 25 | | | | | | | | | | | | | | | | | | | | | | | | | | | | | | |
| 26 | | | | | | | | | | | | | | | | | | | | | | | | | | | | | | |
| 27 | | | | | | | | | | | | | | | | | | | | | | | | | | | | | | |
| 28 | | | | | | | | | | | | | | | | | | | | | | | | | | | | | | |
| 31 | | | | | | | | | | | | | | | | | | | | | | | | | | | | | | |
| 32 | | | | | | | | | | | | | | | | | | | | | | | | | | | | | | |
| 33 | | | | | | | | | | | | | | | | | | | | | | | | | | | | | | |
| 34 | | | | | | | | | | | | | | | | | | | | | | | | | | | | | | |

<Note> 0 : Immediate, 1 : 1 ring delay, 3 : 3 rings delay, 6 : 6 rings delay, 9 : Disable

| Extension No. | [605] Outgoing Permitted ISDN Port Assignment – Day | | | | [606] Outgoing Permitted ISDN Port Assignment – Night | | | | [607] Doorphone Ringing Assignment – Day | | [608] Doorphone Ringing Assignment – Night | |
|-----------------|--|---------|-------------|---------|--|---------|-------------|---------|--|---------|--|---------|
| | ISDN port 1 | | ISDN port 2 | | ISDN port 1 | | ISDN port 2 | | Enable | Disable | Enable | Disable |
| | Enable | Disable | Enable | Disable | Enable | Disable | Enable | Disable | | | | |
| Default: all | ✓ | | ✓ | | ✓ | | ✓ | | Ext. 21 – Enable, Other extensions – Disable | | | |
| All extensions | | | | | | | | | | | | |
| Ext. 21 | | | | | | | | | | | | |
| 22 | | | | | | | | | | | | |
| 23 | | | | | | | | | | | | |
| 24 | | | | | | | | | | | | |
| 25 | | | | | | | | | | | | |
| 26 | | | | | | | | | | | | |
| 27 | | | | | | | | | | | | |
| 28 | | | | | | | | | | | | |
| 31 | | | | | | | | | | | | |
| 32 | | | | | | | | | | | | |
| 33 | | | | | | | | | | | | |
| 34 | | | | | | | | | | | | |
| ISDN extensions | | | | | | | | | | | | |

3.14 Programming Tables

| Extension No. | [609] Extension Connection Assignment | | [610] IRNA Assignment | | [611] TAM Connection Assignment | | [612] Date Line Security | | [613] Department Codes |
|-----------------|---------------------------------------|-------------|-----------------------|---------|---------------------------------|---------|--------------------------|---------|---------------------------------|
| | Connect | Not Connect | Enable | Disable | Enable | Disable | Enable | Disable | Department code (5 digits max.) |
| Default: all | ✓ | | ✓ | | | ✓ | | ✓ | Not Stored |
| All extensions | | | | | | | | | |
| Ext. 21 | ✓ | | | | | | | | |
| 22 | | | | | | | | | |
| 23 | | | | | | | | | |
| 24 | | | | | | | | | |
| 25 | | | | | | | | | |
| 26 | | | | | | | | | |
| 27 | | | | | | | | | |
| 28 | | | | | | | | | |
| 31 | | | | | | | | | |
| 32 | | | | | | | | | |
| 33 | | | | | | | | | |
| 34 | | | | | | | | | |
| ISDN extensions | | | | | | | | | |

3.14 Programming Tables

| | [701] ARS Carrier Code | [703] ARS Authorization Code | | |
|--------------|-------------------------------|---|-------------|-------------|
| | Carrier code (10 digits max.) | Authorization code (20 digits max., 0...9, *) | | |
| | | All ISDN ports | ISDN port 1 | ISDN port 2 |
| Default: all | Not Stored | Not Stored | | |
| Route 1 | | | | |
| Route 2 | | | | |
| Route 3 | | | | |
| Route 4 | | | | |

| [704] ARS Itemized Bill code | | | | | | | | |
|------------------------------|--|----------|---------|----------|---------|----------|---------|----------|
| ISDN Port No. | Route 1 | | Route 2 | | Route 3 | | Route 4 | |
| | Send | Not send | Send | Not send | Send | Not send | Send | Not send |
| Default: all | All routes – All ISDN ports – Not send | | | | | | | |
| All ports | | | | | | | | |
| ISDN Port1 | | | | | | | | |
| ISDN Port2 | | | | | | | | |

| | [708] ARS Modify Removed Digit | [709] ARS Modify Added Number |
|--------------|--|---|
| | Number of digits to be deleted (0...9) | Number to be added (0...9, 20 digits maximum) |
| Default: all | 0 digit (no deletion) | Not Stored |
| Route 1 | | |
| Route 2 | | |
| Route 3 | | |
| Route 4 | | |

3.14 Programming Tables

| [702] ARS Route Selection Code | | | | |
|--------------------------------|----------------------------|---------|---------|---------|
| Area No. | Area Code (7 digits max.) | | | |
| | Default : All – Not Stored | | | |
| | Route 1 | Route 2 | Route 3 | Route 4 |
| 00 | | | | |
| 01 | | | | |
| 02 | | | | |
| 03 | | | | |
| 04 | | | | |
| 05 | | | | |
| 06 | | | | |
| 07 | | | | |
| 08 | | | | |
| 09 | | | | |
| 10 | | | | |
| 11 | | | | |
| 12 | | | | |
| 13 | | | | |
| 14 | | | | |
| 15 | | | | |
| 16 | | | | |
| 17 | | | | |
| 18 | | | | |
| 19 | | | | |
| 20 | | | | |
| 21 | | | | |
| 22 | | | | |
| 23 | | | | |
| 24 | | | | |
| 25 | | | | |
| 26 | | | | |
| 27 | | | | |
| 28 | | | | |
| 29 | | | | |
| 30 | | | | |
| 31 | | | | |
| 32 | | | | |
| 33 | | | | |
| 34 | | | | |
| 35 | | | | |
| 36 | | | | |
| 37 | | | | |
| 38 | | | | |
| 39 | | | | |

3.14 Programming Tables

| [702] ARS Route Selection Code | | | | |
|--------------------------------|----------------------------|---------|---------|---------|
| Area No. | Area Code (7 digits max.) | | | |
| | Default : All – Not Stored | | | |
| | Route 1 | Route 2 | Route 3 | Route 4 |
| 40 | | | | |
| 41 | | | | |
| 42 | | | | |
| 43 | | | | |
| 44 | | | | |
| 45 | | | | |
| 46 | | | | |
| 47 | | | | |
| 48 | | | | |
| 49 | | | | |
| 50 | | | | |
| 51 | | | | |
| 52 | | | | |
| 53 | | | | |
| 54 | | | | |
| 55 | | | | |
| 56 | | | | |
| 57 | | | | |
| 58 | | | | |
| 59 | | | | |
| 60 | | | | |
| 61 | | | | |
| 62 | | | | |
| 63 | | | | |
| 64 | | | | |
| 65 | | | | |
| 66 | | | | |
| 67 | | | | |
| 68 | | | | |
| 69 | | | | |
| 70 | | | | |
| 71 | | | | |
| 72 | | | | |
| 73 | | | | |
| 74 | | | | |
| 75 | | | | |
| 76 | | | | |
| 77 | | | | |
| 78 | | | | |
| 79 | | | | |

3.14 Programming Tables

| [706] ARS Route Exceptional Code | | | | |
|----------------------------------|-------------------------------|---------|---------|---------|
| Area No. | Excepted Code (7 digits max.) | | | |
| | Default : All – Not Stored | | | |
| | Route 1 | Route 2 | Route 3 | Route 4 |
| 00 | | | | |
| 01 | | | | |
| 02 | | | | |
| 03 | | | | |
| 04 | | | | |
| 05 | | | | |
| 06 | | | | |
| 07 | | | | |
| 08 | | | | |
| 09 | | | | |
| 10 | | | | |
| 11 | | | | |
| 12 | | | | |
| 13 | | | | |
| 14 | | | | |
| 15 | | | | |
| 16 | | | | |
| 17 | | | | |
| 18 | | | | |
| 19 | | | | |
| 20 | | | | |
| 21 | | | | |
| 22 | | | | |
| 23 | | | | |
| 24 | | | | |
| 25 | | | | |
| 26 | | | | |
| 27 | | | | |
| 28 | | | | |
| 29 | | | | |
| 30 | | | | |
| 31 | | | | |
| 32 | | | | |
| 33 | | | | |
| 34 | | | | |
| 35 | | | | |
| 36 | | | | |
| 37 | | | | |
| 38 | | | | |
| 39 | | | | |

3.14 Programming Tables

| [706] ARS Route Exceptional Code | | | | |
|----------------------------------|-------------------------------|---------|---------|---------|
| Area No. | Excepted Code (7 digits max.) | | | |
| | Default : All – Not Stored | | | |
| | Route 1 | Route 2 | Route 3 | Route 4 |
| 40 | | | | |
| 41 | | | | |
| 42 | | | | |
| 43 | | | | |
| 44 | | | | |
| 45 | | | | |
| 46 | | | | |
| 47 | | | | |
| 48 | | | | |
| 49 | | | | |
| 50 | | | | |
| 51 | | | | |
| 52 | | | | |
| 53 | | | | |
| 54 | | | | |
| 55 | | | | |
| 56 | | | | |
| 57 | | | | |
| 58 | | | | |
| 59 | | | | |
| 60 | | | | |
| 61 | | | | |
| 62 | | | | |
| 63 | | | | |
| 64 | | | | |
| 65 | | | | |
| 66 | | | | |
| 67 | | | | |
| 68 | | | | |
| 69 | | | | |
| 70 | | | | |
| 71 | | | | |
| 72 | | | | |
| 73 | | | | |
| 74 | | | | |
| 75 | | | | |
| 76 | | | | |
| 77 | | | | |
| 78 | | | | |
| 79 | | | | |

Section 4
Installation

4.1 *Before Installation*

Please read the following concerning installation and connection before installing the system.

Safety Installation Instructions

When installing telephone wiring, basic safety precautions should always be followed to reduce the risk of fire, electric shock and injury to persons, including the following:

1. Never install telephone wiring during a lightning storm.
2. Never install telephone jacks in wet locations unless the jack is specifically designed for wet locations.
3. Never touch uninsulated telephone wires or terminals unless the telephone line has been disconnected at the network interface.
4. Use caution when installing or modifying telephone lines.

Installation Precautions

This set is exclusively made for wall mounting only. Avoid installing in the following places. (Doing so may result in malfunction, noise, or discolouration.)

1. In direct sunlight and hot, cold, or humid places. (Temperature range: 0°C – 40°C)
2. Sulfuric gases produced in areas where there are thermal springs, etc. may damage the equipment or contacts.
3. Places where shocks or vibrations are frequent or strong.
4. Dusty places, or places where water or oil may come into contact with the unit.
5. Near high-frequency generating devices such as sewing machines or electric welders.
6. On or near computers, telexes, or other office equipment, as well as microwave ovens or air conditioners. (It is preferable not to install the unit in the same room with the above equipment.)
7. Install at least 1.8 m away from radios and televisions. (Both the main unit and proprietary telephones)
8. Do not obstruct area around the main unit (for maintenance and inspection — be especially careful to allow space for cooling above and on the sides of the main unit).

Wiring Precautions

Make sure to keep the following instructions when wiring.

1. Do not wire the telephone cable in parallel with an AC power source, computer, telex, etc. If the cables are run near those wires, shield the cables with metal tubing or use shielded cables and ground the shields.
2. If cables are run on the floor, use protectors or the like to protect the wires where they may be stepped on. Avoid wiring under carpets.
3. Avoid using the same power supply outlet for computers, telexes, and other office equipment. Otherwise, system operation may be interrupted by the induction noise from such equipment.
4. Please use one pair telephone wire for extension connection of (telephone) equipment such as single line telephones, data terminals, answering machines, computers, etc.

4.1 Before Installation

5. Unplug the system during wiring. After all of the wiring is completed, plug in the system.
6. Mis-connection may cause the system to operate improperly.
Refer to Section 4.7 “ISDN Line Connection Structure”.
7. Mis-wiring may cause the system to operate improperly.
Refer to Section 5.6.1 “Installation and Operation” and Section 5.6.2 “Connection”.
8. If an extension does not operate properly, disconnect the telephone from the extension line and connect it again, or unplug the system and plug in the system again.
9. The system is equipped with a 3-wire grounding type plug. This is a safety feature.
If you are unable to insert the plug into the outlet, contact your electrician to replace your obsolete outlet.
10. Use an ISDN line cord (cross type) for outside line (CO) connection.
11. CO lines should be installed with lightning protectors. For details, refer to Section 5.16 “Installing the Lightning Protector”.

Warning:

Static sensitive devices are used.
To protect printed circuit boards from static electricity, do not touch the connector indicated to the right without first discharging body static by touching a ground or wearing a properly installed grounding strap.

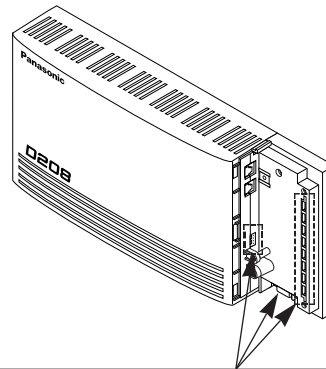

Warning : Static sensitive connector

4.2 Unpacking

| | | | |
|---------------------|-----|------------------------------------|--------|
| Main Unit..... | one | Screws and Washers | three |
| AC Cord..... | one | 4-pin Plugs..... | eleven |
| ISDN Line Cord..... | one | Floppy Disk for PC Programming ... | one |

4.3 Names and Locations

Overview of the Main Unit

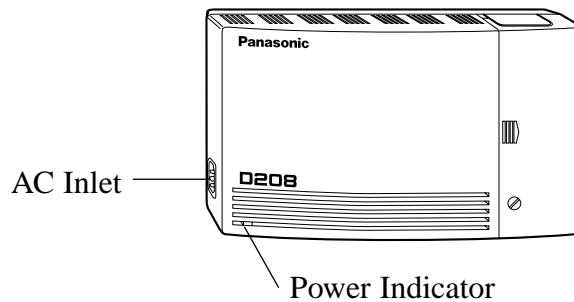

Inside View of the Main Unit

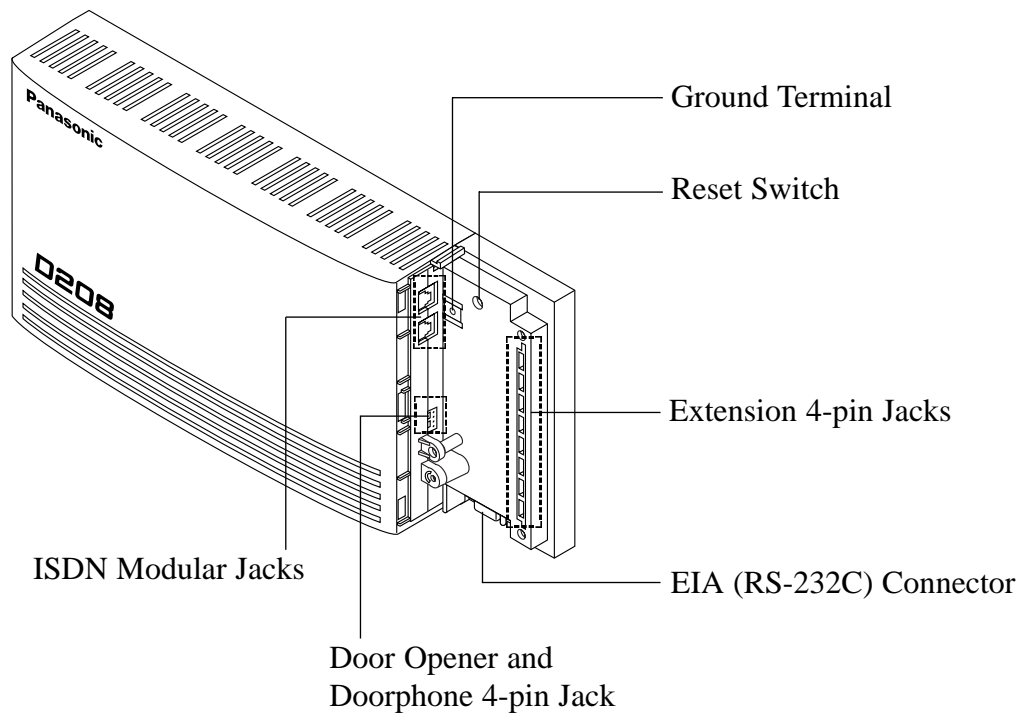

4.4 Wall Mounting

1. Place the template (on page 5-16) on the wall to mark the three screw positions.
2. Install the three screws and washers (included) into the wall.
3. Hook the main unit on the screw heads.

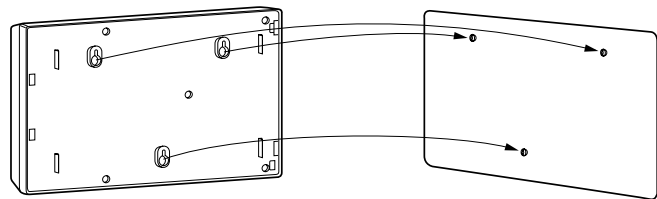
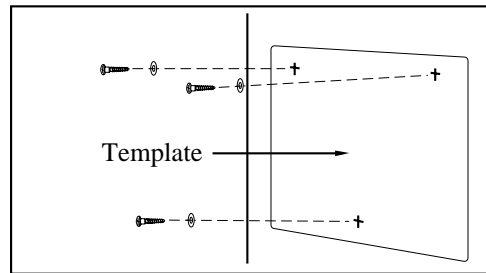

4.5 Opening the Front Cover

1. Loosen the screw.
2. Slide the cover in the direction of the arrow while pressing the arrow mark (▮).

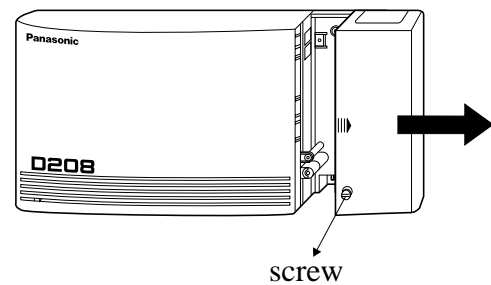

4.6 Connecting the Frame Earth

IMPORTANT!!!

Connect the frame of the main unit to the earth.

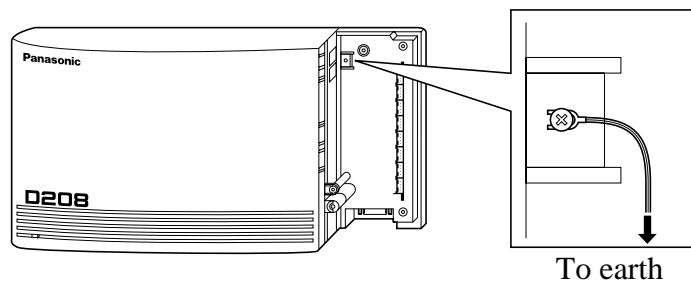

4.7 ISDN Line Connection Structure

The possible connection structures of ISDN lines for outside line (CO) use, depending on the contract, are shown below.

Because the Termination Register (TR) must be placed at the end of the connection, we recommend the B-2 connection. If the A and B-1 connections are necessary, you need to consult with your dealer.

A: When your contract is Point-to-Point

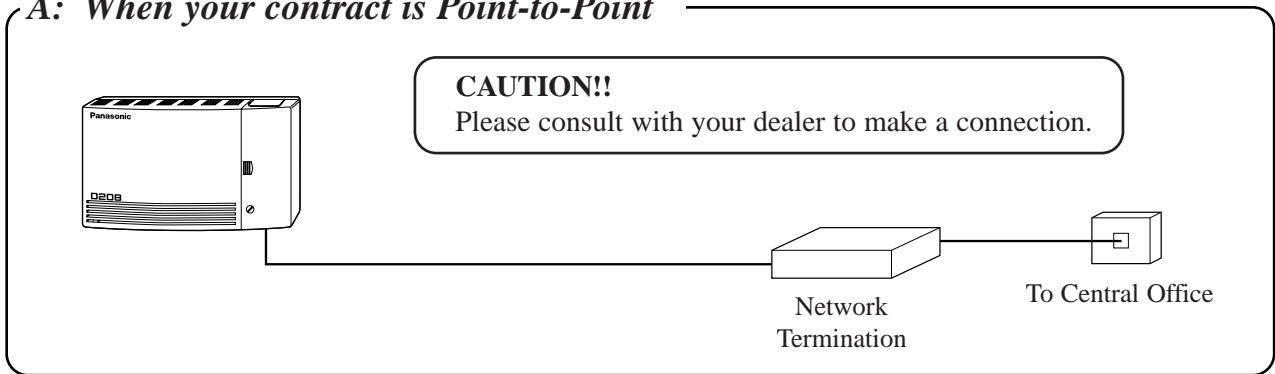

B: When your contract is Point-to-Multi-Point

B-1: Your system is at the end of the connection

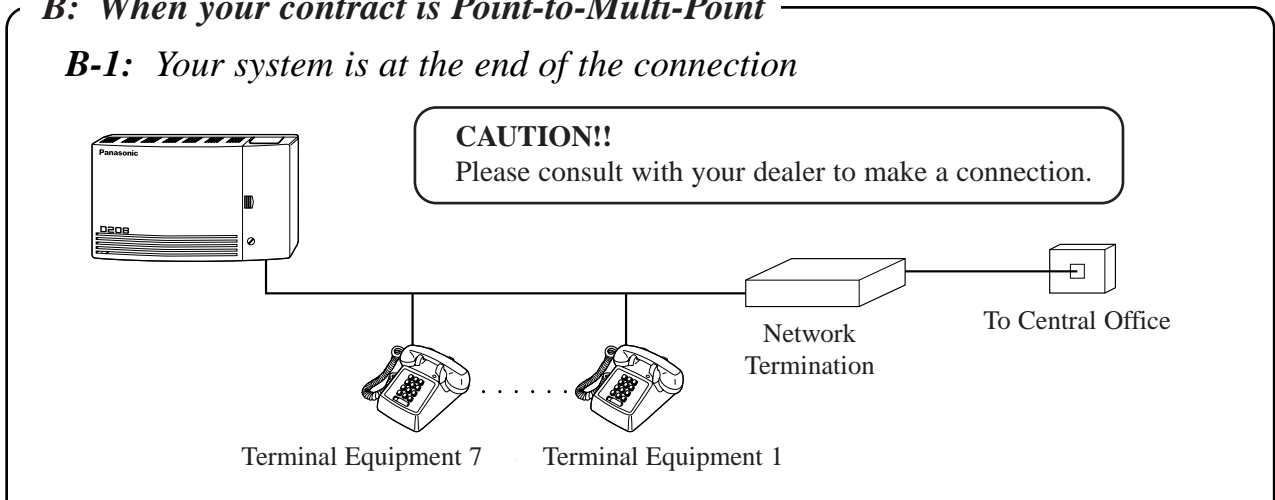

B-2: Your system is not at the end of the connection

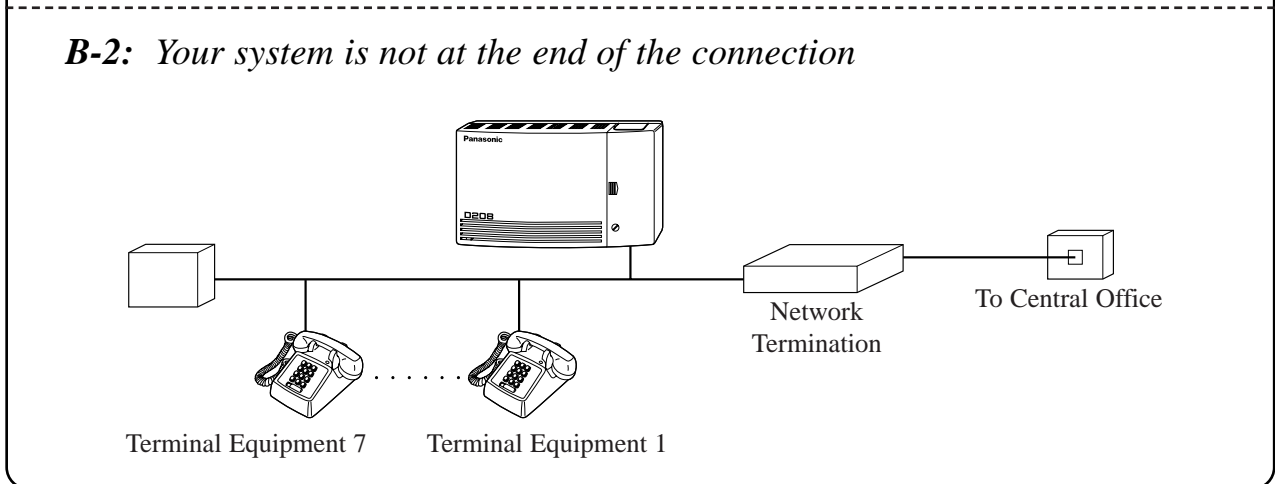

4.8 *Outside Line (CO) Connection*

Wire Specifications

When making a line connection, use an ISDN line cord (cross type) (included) for installation. The wire specifications are as follows:

| | |
|------------------------------|----------------|
| Wire | Solid wire |
| Diameter of conductor | 0.4 – 0.65 mm |
| Diameter with coating | 0.66 – 1.05 mm |

Connection

Two CO lines can be connected to ISDN port 1. Insert the modular plug of the ISDN line cord (8-conductor wiring) into ISDN port 1 on the system.

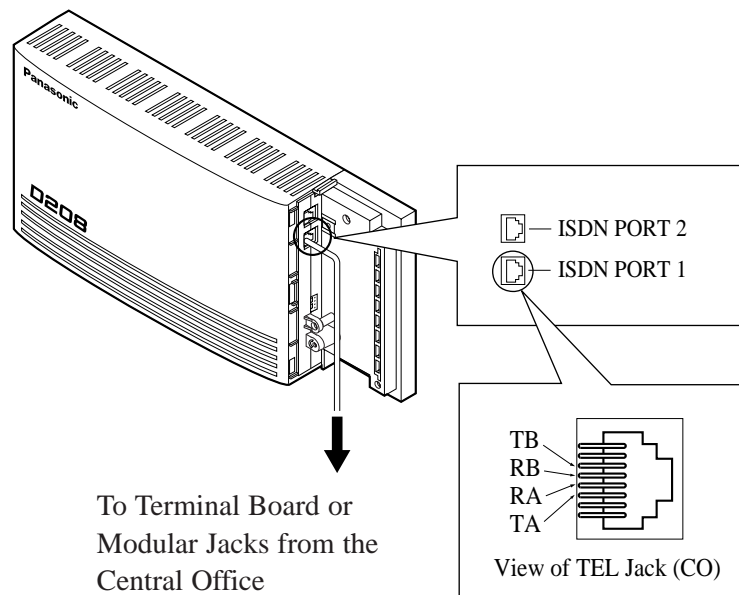

- Mis-connection may cause the system to operate improperly. See Section 5.6.1 "Installation and Operation" and 5.6.2 "Connection".

4.9 Extension Connection

Wire Specifications

The wire specifications are as follows:

| | |
|------------------------------|--------------|
| Wire | Solid wire |
| Diameter of conductor | 0.4 – 0.6 mm |

Connection Cable

2 or 4-conductor wiring is required for each extension as listed below. Required pins are “T,” “R,” “L” and “H.”

| | |
|---------|---------|
| T: Tip | L: Low |
| R: Ring | H: High |

| TELEPHONE | WIRING |
|--|---|
| Single line telephones | 1 pair wire (T, R) |
| KX-T7230, KX-T7235, KX-T7250 KX-T7425, KX-T7433, KX-T7436 | 1 pair wire (L, H) or 2 pair wire (L, H, T, R) for XDP |

Connection

Use a 4-pin plug (eight included) to connect extension lines.

EXTN. 1 through EXTN. 4 jacks can be used for all telephones, while EXTN. 5 through EXTN. 8 jacks can only be used for Single Line Telephones (SLTs).

To connect proprietary telephones, a 4 Extension Expansion Card (KX-TD20870) is required to be installed beforehand.

EXTN. 1 through EXTN. 8 jacks correspond to extension numbers 21 through 28 respectively.

1. Lift the transparent part of the plug.
2. Insert the required telephone wires into the holes of the plug.
Then press the transparent part back into the black part.

Note: Do not strip the wires. Insert the wires all the way into the plug.

4-pin plug for 2 pair wire

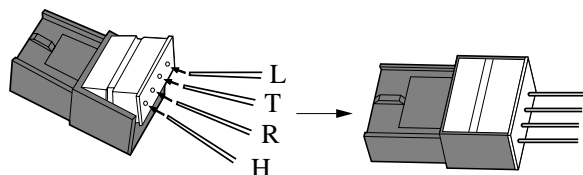

4-pin plug for 1 pair wire

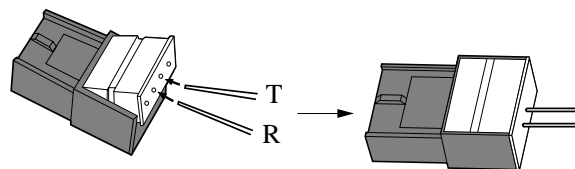

4.9 Extension Connection

3. Insert the plug into an extension jack in the main unit.

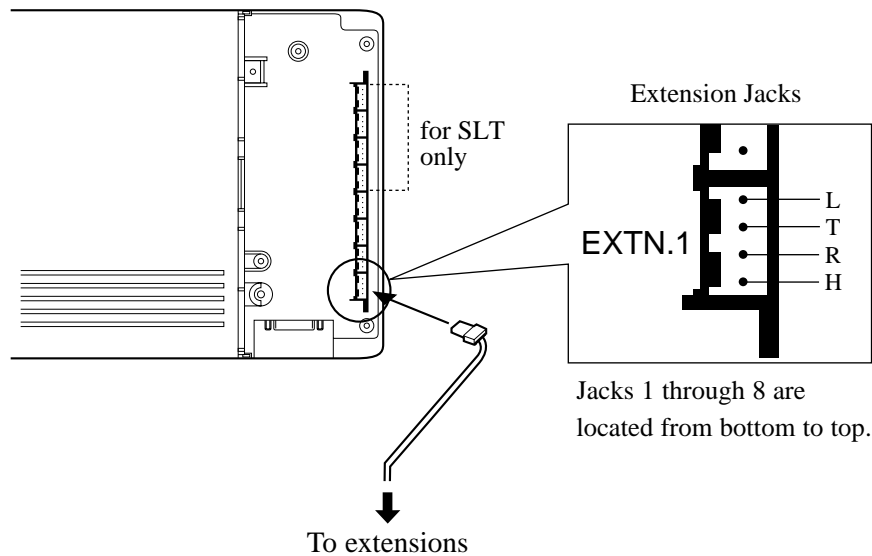

4. Connect the extensions.



- !**
- To connect proprietary telephones, a 4 Extension Expansion Card (KX-TD20870) is required to be installed.
 - The maximum length of the extension line cord (twisted cable) that connects the main unit and the extension is as follows:

| | Diameter of the line | Maximum length |
|-----|----------------------|----------------|
| SLT | 0.5 mm | 620 m |
| PT | 0.5 mm | 240 m |

4.10 Connecting the Telephones in Parallel

A single line telephone can be connected in parallel, using one extension number, with any proprietary telephone.

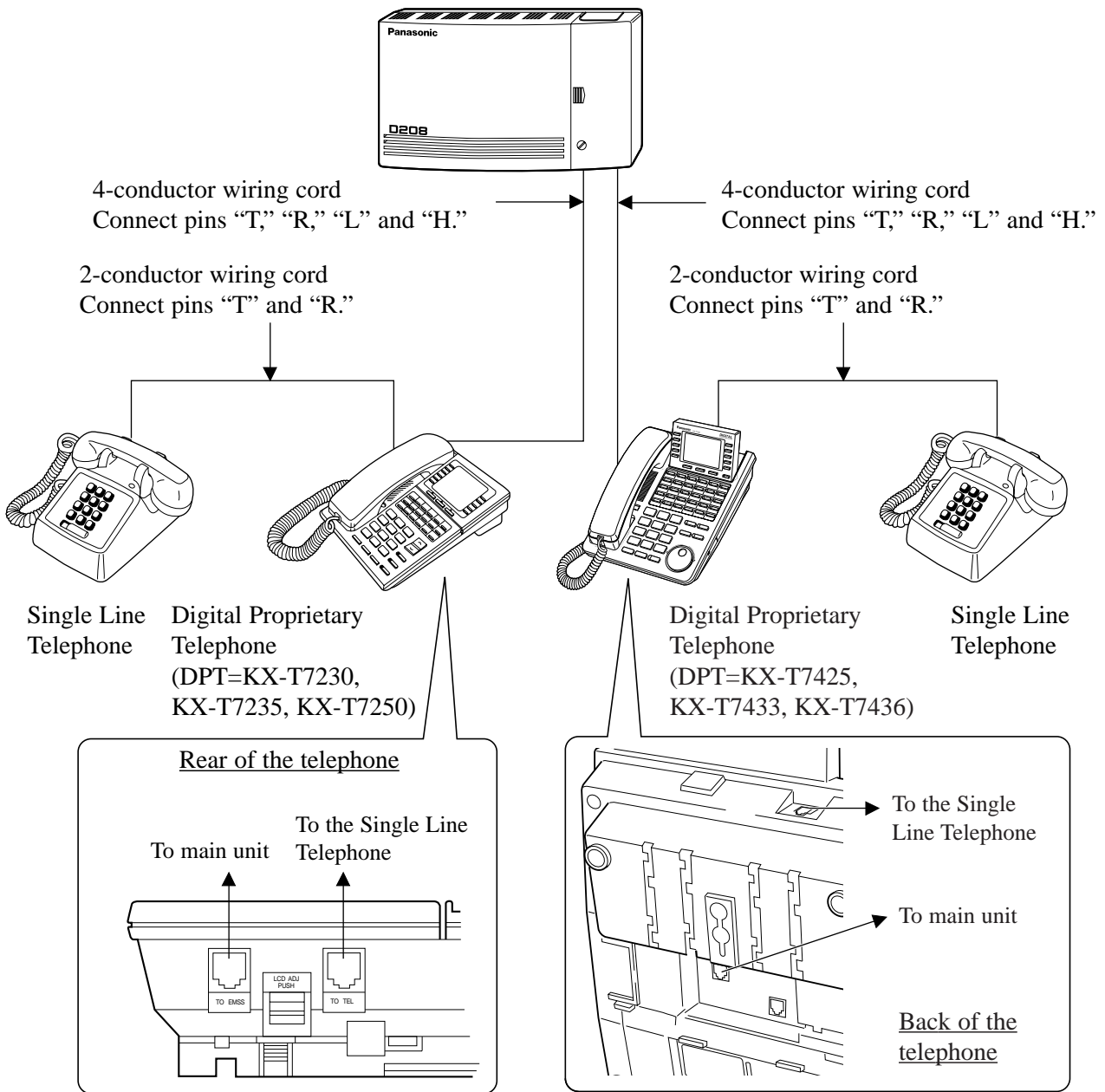

- Not only a single line telephone but a single line device such as an answering machine, facsimile, modem, (personal computer) etc. can be connected in parallel with a digital proprietary telephone.



- Others (Section 2.6)
Setting the Paralleled SLT to Ring (Paralleled Telephone Connection)

4.11 Connecting the Telephones in EXtra Device Port (XDP)

With the EXtra Device Port (XDP) connection, a single line telephone and a digital proprietary telephone can be connected to the same extension jack and have different extension numbers. System programming is required.

Method 1

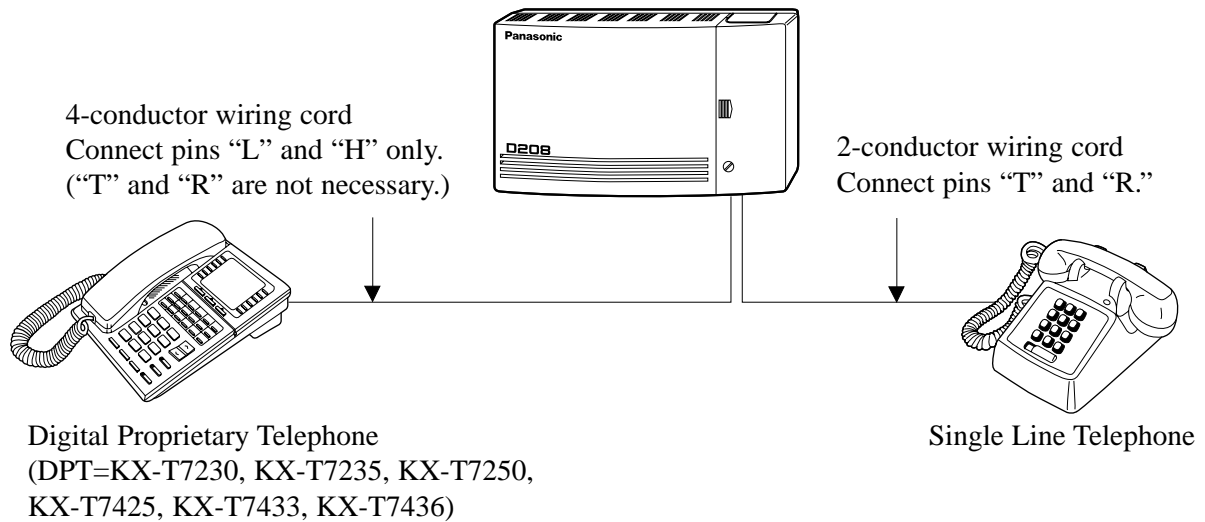

Method 2

Section 4.10 "Connecting the Telephones in Parallel" is also available for XDP connection.



- System Management (Section 3.1)
EXtra Device Port (XDP)
- Extension Programming (Section 3.9)
[600] EXtra Device Port

4.12 *Installing the Optional Cards*

1. Disconnect the AC cord from the system.
2. Loosen the screw.

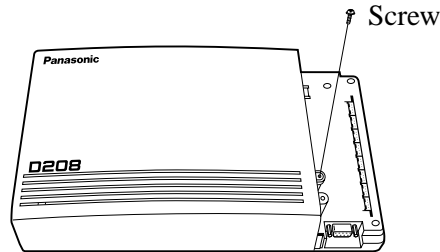

3. Remove the cover by pressing both tabs and lifting up.

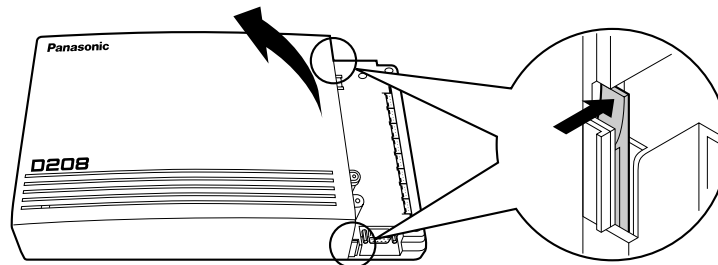

4. Attach the ISDN Line Card to the marked connector.

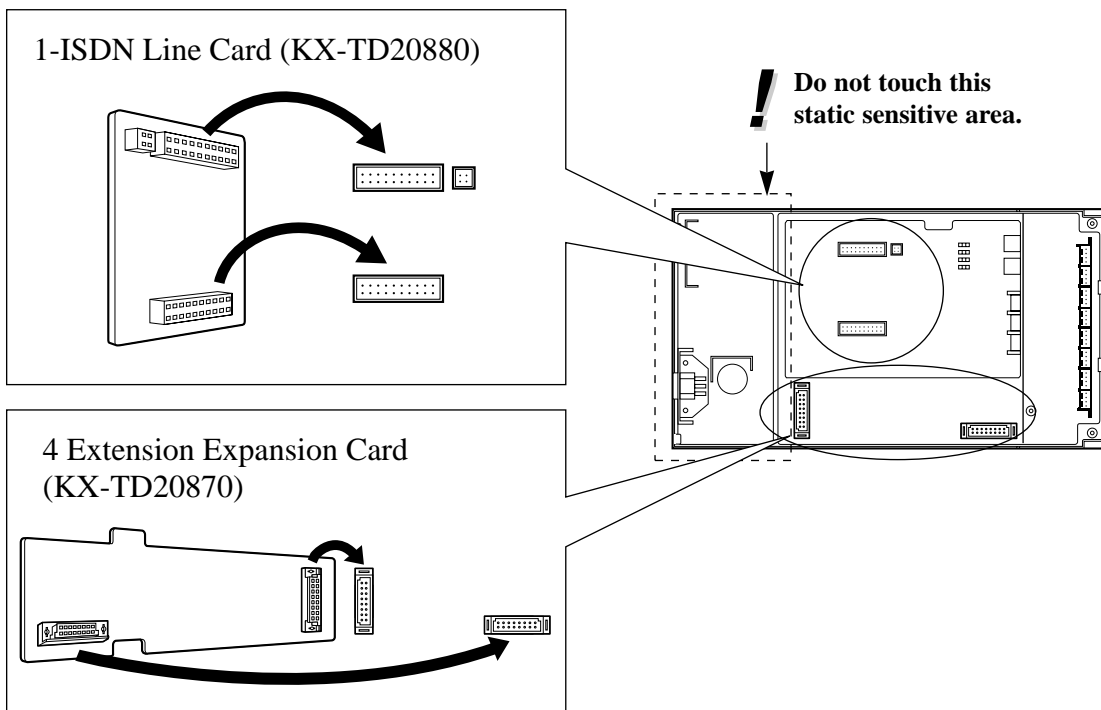

4.12 *Installing the Optional Cards*

5. If 1-ISDN Line Card is installed, adjust the extension/outside line (CO) switch socket depending on how the card, outside line (CO) or extension line (default: outside line (CO)), is used.
If installing a 4 Extension Expansion Card, skip this step.

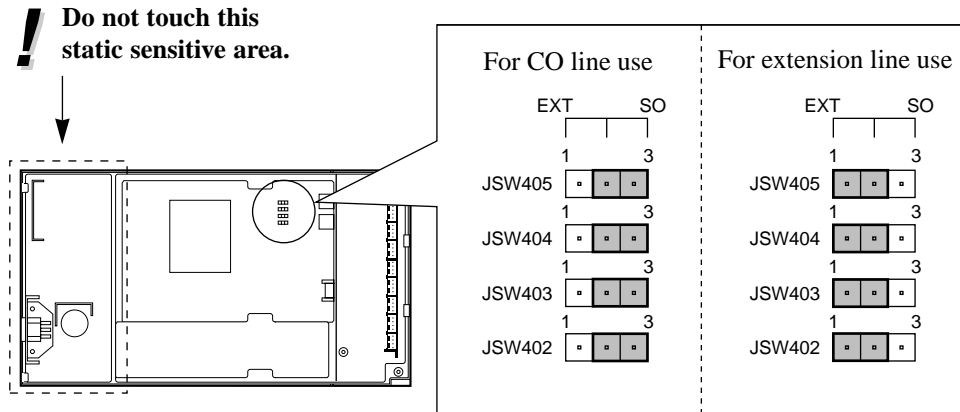

6. Replace the cover and secure the screw.
7. Connect the AC cord again.

4.13 Expanding the ISDN Line Connection

After installing the ISDN Line Card (KX-TD20880), two CO lines or eight ISDN extension lines can be connected on ISDN port 2.

When making a line connection, use an ISDN line cord (cross type) (included) for installation. Insert the modular plug of the ISDN line cord (8-conductor wiring) into ISDN port 2 on the system.

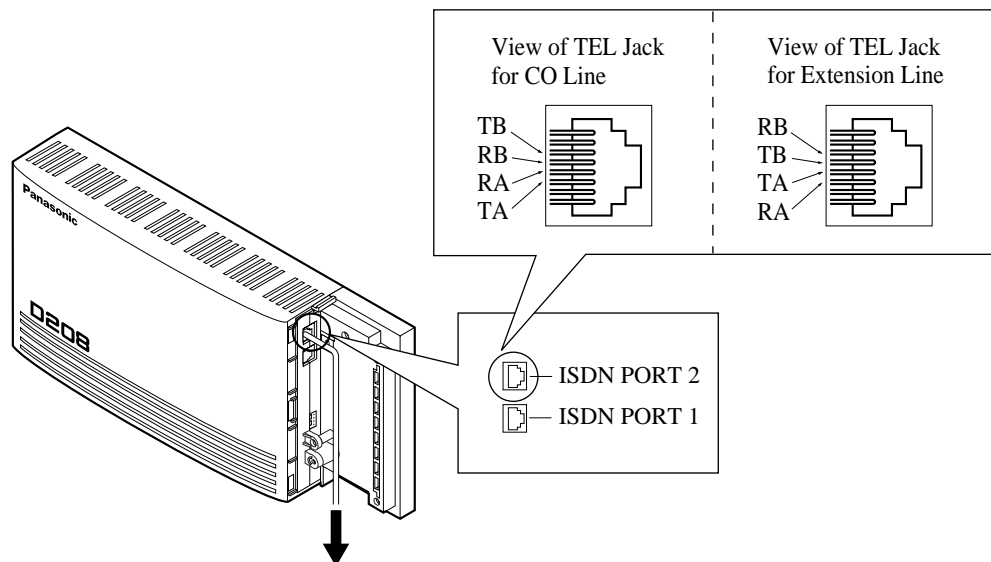

To Terminal Board or Modular Jacks from the Central Office, or ISDN extensions.



- System Programming is required depending on the port type.

Outside line (CO):

- Select “Connect” for ISDN port 2 in program [400] “ISDN Port Connection Assignment” (default: Not connect).
- Select the configuration for ISDN port 2 in program [406] “ISDN Configuration” (default: Outside line (CO) / Point-to-multi-point).

Extension line:

- Select the configuration for ISDN port 2 in program [406] “ISDN Configuration” (default: Outside line (CO) / Point-to-multi-point).
- Refer to Section 4.8 “Outside Line (CO) Connection” for the wire specifications.
- Mis-connection may cause the system to operate improperly. See Section 5.6.1 “Installation and Operation” and 5.6.2 “Connection.”
- The pin number assignment changes depending on how the extension/outside line (CO) switch socket is adjusted. (Refer to page 5-13.)

4.14 Connecting the Doorphone and Door Opener

One doorphone (KX-T30865) and/or user-supplied door opener can be connected to the system. For doorphone connection, prepare for the doorphone beforehand.

Installing the Doorphone

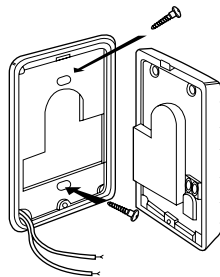
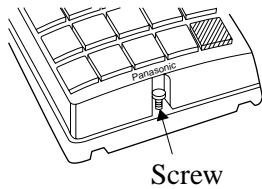

1. Loosen the screw to separate the doorphone into halves.

2. Attach the base cover to the wall with two screws.

Note: Two kinds of screws are included; choose the appropriate one depending on your wall type:

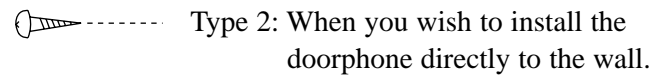
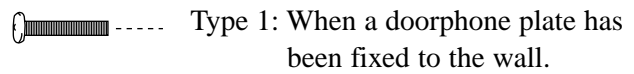

3. Connect the wires from the main unit to the screws located in the front cover.

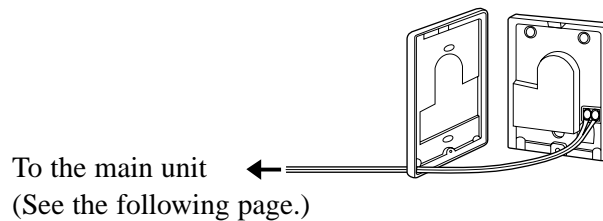

4. Re-attach the halves and re-install the screw.

Connection

Use a 4-pin plug (included) for connection.

1. Lift the transparent part of the plug.
2. Insert the required wires into the holes of the plug.
Then press the transparent part back into the black part.

Note: Do not strip the wires. Insert the wires all the way into the plug.

4-pin plug

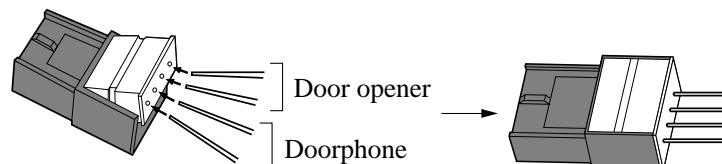

4.14 Connecting the Doorphone and Door Opener

3. Insert the plug into the desired jack in the main unit.

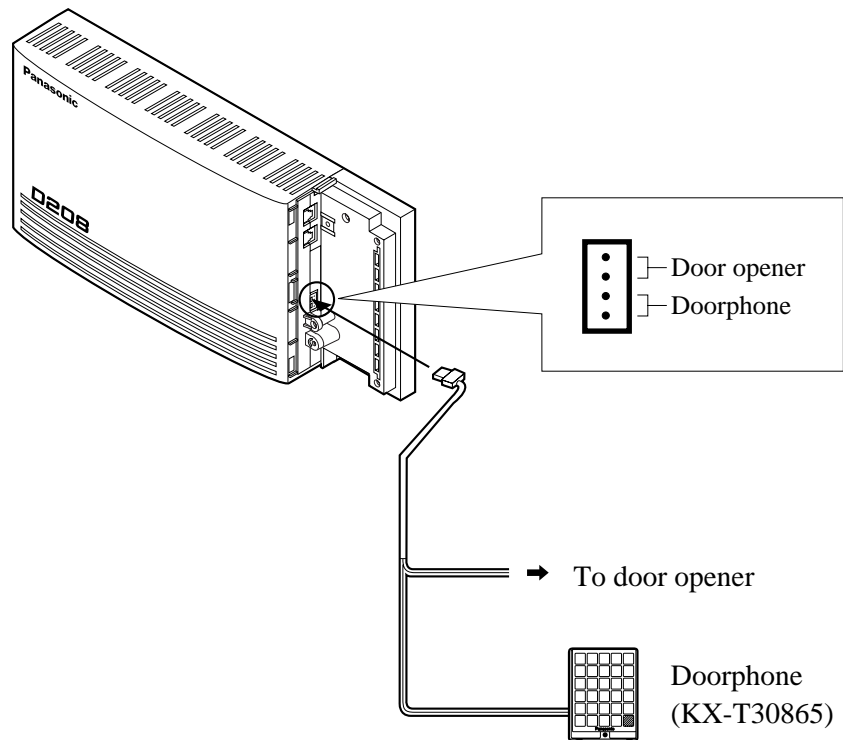

- The maximum length of the doorphone and door opener line that connects to the main unit is as follows:

| Diameter of the line | Maximum length |
|----------------------|----------------|
| 0.5 mm | 120 m |



- Others (Section 2.6)
 - Unlocking a Door (Door Opener)
 - Doorphone Call
- System Programming (Section 3.4)
 - [105] Automatic Door Open Assignment
- Extension Programming (Section 3.9)
 - [607]–[608] Doorphone Ringing Assignment — Day/Night

4.15 *Connecting the Printer and PC*

A user-supplied printer or personal computer (PC) can be connected to the Serial Interface (RS-232C) Connector (9-pin) on the main unit. The printer is used to print out SMDR call records and system programming data. The PC is used for system programming.

Connect the Serial Interface (RS-232C) connector of the printer or the PC to the Serial Interface Connector. Cables must be shielded and the maximum length is 2 m.

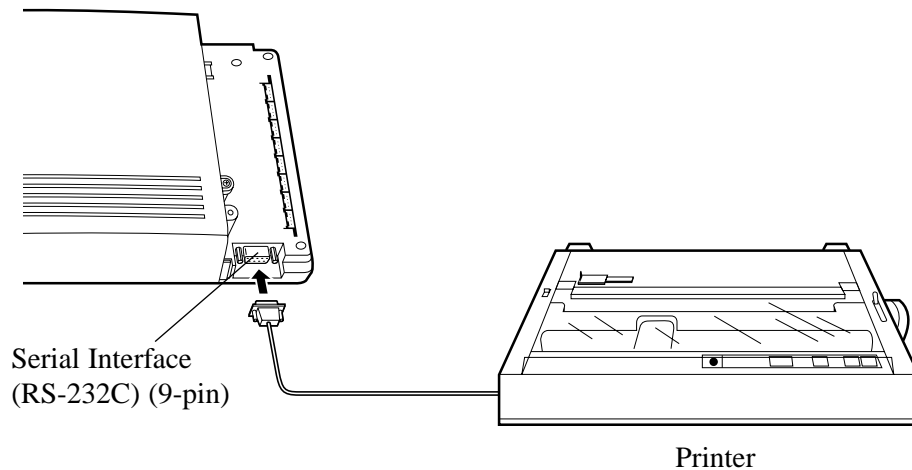

Arrange the cables so that the printer or the PC will be connected to the system as shown in the chart on the following page.

The pin configuration of the EIA (RS-232C) Connector is as follows:

| Pin No. | Signal Name | | Circuit Type | |
|---------|-------------|---------------------|--------------|-------|
| | | | EIA | CCITT |
| 2 | RXD | Received Data | BB | 104 |
| 3 | TXD | Transmitted Data | BA | 103 |
| 4 | DTR | Data Terminal Ready | CD | 108.2 |
| 5 | SG | Signal Ground | AB | 102 |
| 6 | DSR | Data Set Ready | CC | 107 |
| 7 | RTS | Request To Send | CA | 105 |
| 8 | CTS | Clear To Send | CB | 106 |

4.15 Connecting the Printer and PC

Connection Chart for Printer / IBM Personal Computer (9-pin)

If you connect a printer or an IBM-PC with a 9-pin EIA (RS-232C) connector to your system, see the chart below.

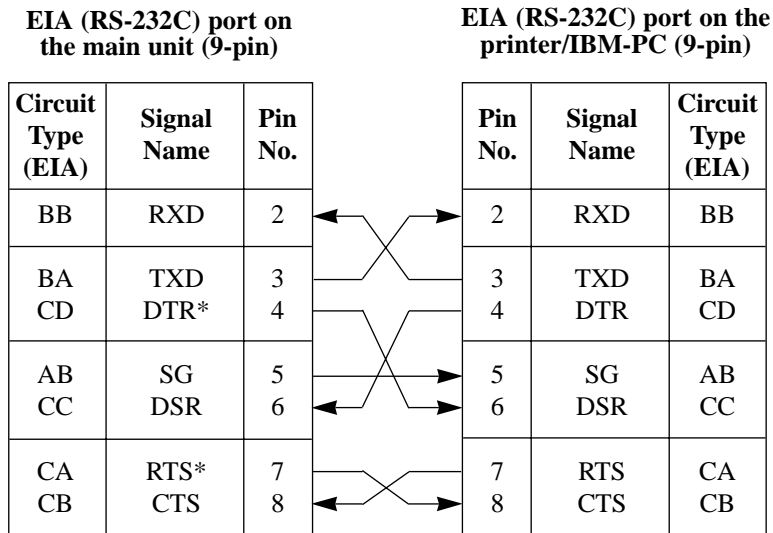

*RTS (7-pin) and DTR (4-pin) are connected on the board.

Connection Chart for Printer / Personal Computer (25-pin)

If you connect a printer or a PC with a 25-pin EIA (RS-232C) connector to your system, see the chart below.

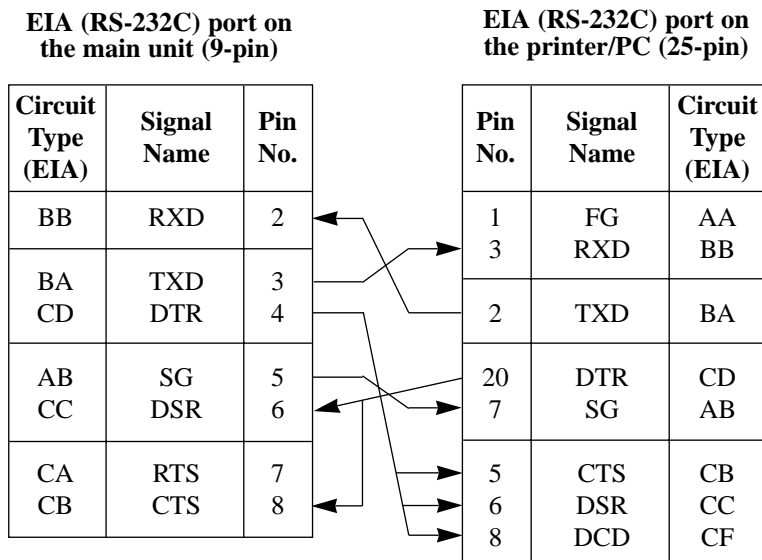

4.15 *Connecting the Printer and PC*

EIA (RS-232C) Signals

Frame Ground: FG

Connects to the unit frame and the earth ground conductor of the AC power cord.

Transmitted Data: TXD(output)

Conveys signals from the unit to the printer or the PC. A “Mark” condition is held unless data or BREAK signals are being transmitted.

Received Data: RXD(input)

Conveys signals from the printer or the PC.

Request to Send: RTS(output)

This lead is held ON whenever DSR is ON.

Clear To Send: CTS(input)

An ON condition for the circuit CTS indicates the printer or the PC is ready to receive data from the unit. The unit does not attempt to transfer data or receive data when the circuit CTS is OFF.

Data Set Ready: DSR(input)

An ON condition for the circuit DSR indicates the printer or the PC is ready. Circuit DSR ON does not indicate that communication has been established with the printer or the PC.

Signal Ground: SG

Connects to the DC ground of the unit for all interface signals.

Data Terminal Ready: DTR(output)

This signal line is turned ON by the unit to indicate that it is ON LINE. Circuit DTR ON does not indicate that communication has been established with the printer or the PC. It is switched OFF when the unit is OFF LINE.

Data Carrier Detect: DCD(input)

The ON condition is an indication to the data terminal (DTE) that the carrier signal is being received.



- System Management (Section 3.1)
 - Station Message Detail Recording (SMDR)
 - System Programming with a Personal Computer
- Resource Programming (Section 3.11)
 - [800] SMDR Incoming/Outgoing Call Log Printout
 - [801] SMDR Format
 - [802] System Data Printout
 - [804] Serial Interface (RS-232C) Parameters

4.16 *Installing the Lightning Protector*

A lightning protector is a device to be installed on a outside line (CO) to prevent a dangerous surge from entering the building and damaging equipment. A dangerous surge can occur if a telephone line comes in contact with a power line. Problems due to lightning surges have been showing a steady increase with the development of electronic equipment. In many countries, there are regulations requiring the installation of a lightning protector. A lightning strike to a telephone cable which is 10 m above ground can be as high as 200,000 volts. This system should be installed with lightning protectors. In addition, grounding (connection to an earth ground) is very important for the protection of the system.

Installation Diagram

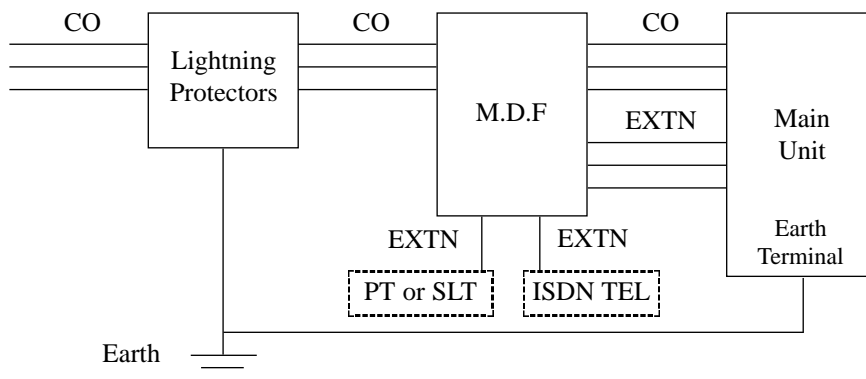

Outside Installation Diagram

If you install an extension outside of the main building, the following precautions are recommended:

- (1) Install the extension wire underground.
- (2) Use a conduit to protect the wire.

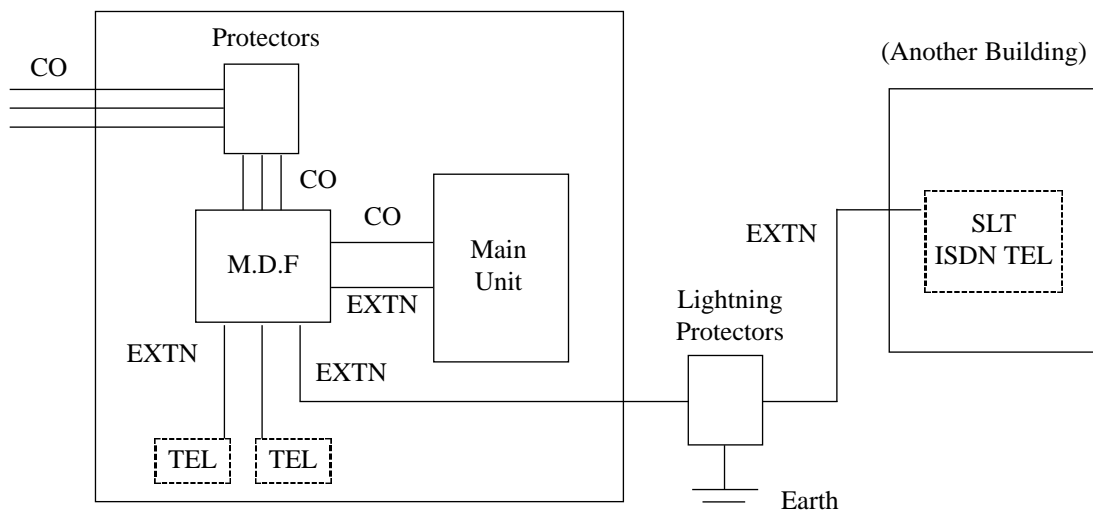

4.16 *Installing the Lightning Protector*

Installation of an Earth Rod

The length of the earth rod and required depth depend on the composition of the soil. Consider the following recommendations:

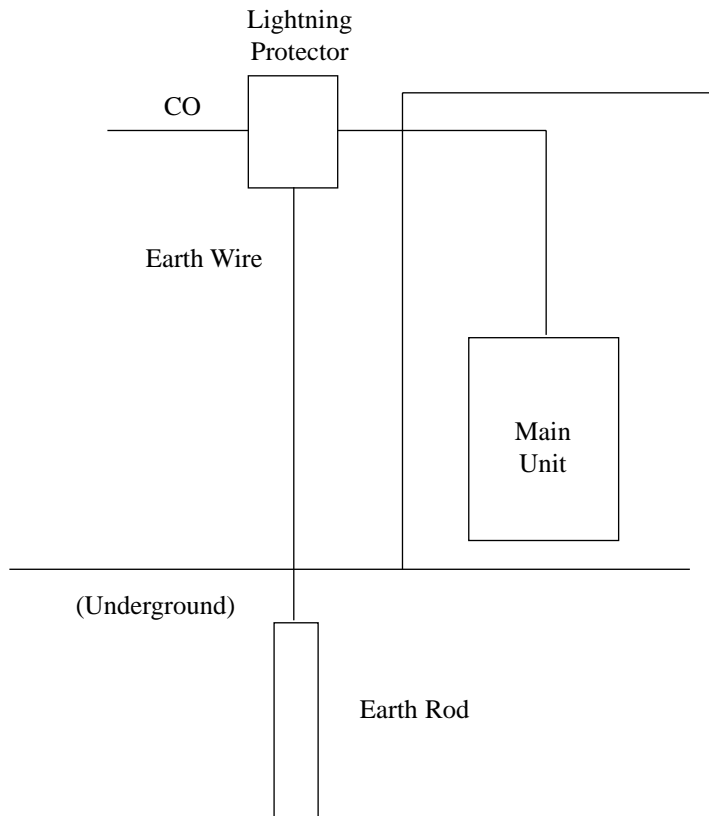

- (1) Installation location of the earth rodNear the protector
- (2) Check obstructionsNone
- (3) Composition of the earth rod.....Metal
- (4) Depth of the earth rod.....More than 50 cm
- (5) Size of the earth wire.....Thickness is greater than 1.6 mm

4.17 Closing the Front Cover

1. Slide the cover in the direction of the arrow.
2. Tighten the screw.
3. Tie together all of the connected cords and attach them to the wall so that the cords cannot be pulled out of the unit.

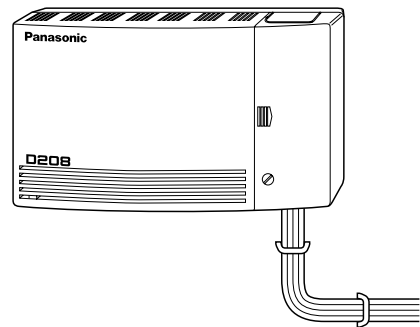
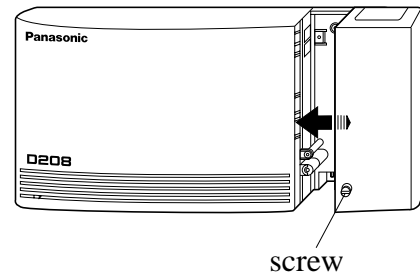

4.18 Starting the System for the First Time

Plug the AC cord into the system and an AC outlet.
(The power indicator of the system is lit.)

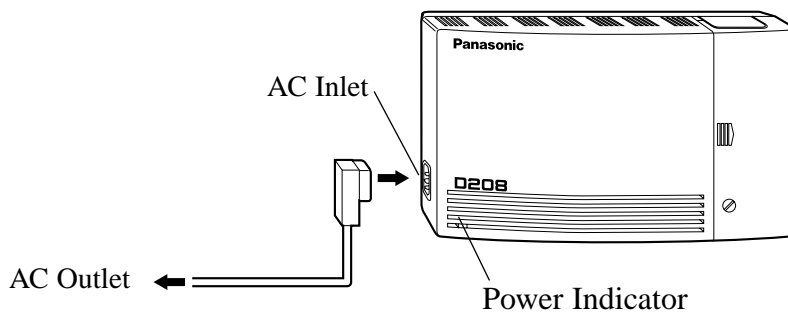

- ! • Use only the supplied AC cord for the purpose of applying the EMC standard, if a KX-TD208 is connected.

4.19 *Restarting the System*

After starting the system, if the system does not operate properly, restart the system by pressing the Reset Switch with a pointed tool. System Restart causes the following:

- Camp-On is cleared.
- Calls on Hold are terminated.
- Calls in progress are terminated.
- Call Park is cleared.

All other data, except the above, are not cleared by System Restart.

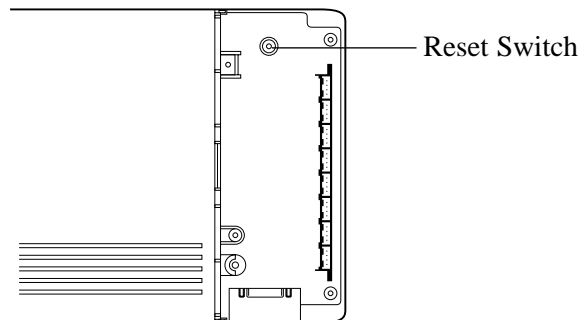

Section 5
Appendix

5.1 Tones / Ring Tones

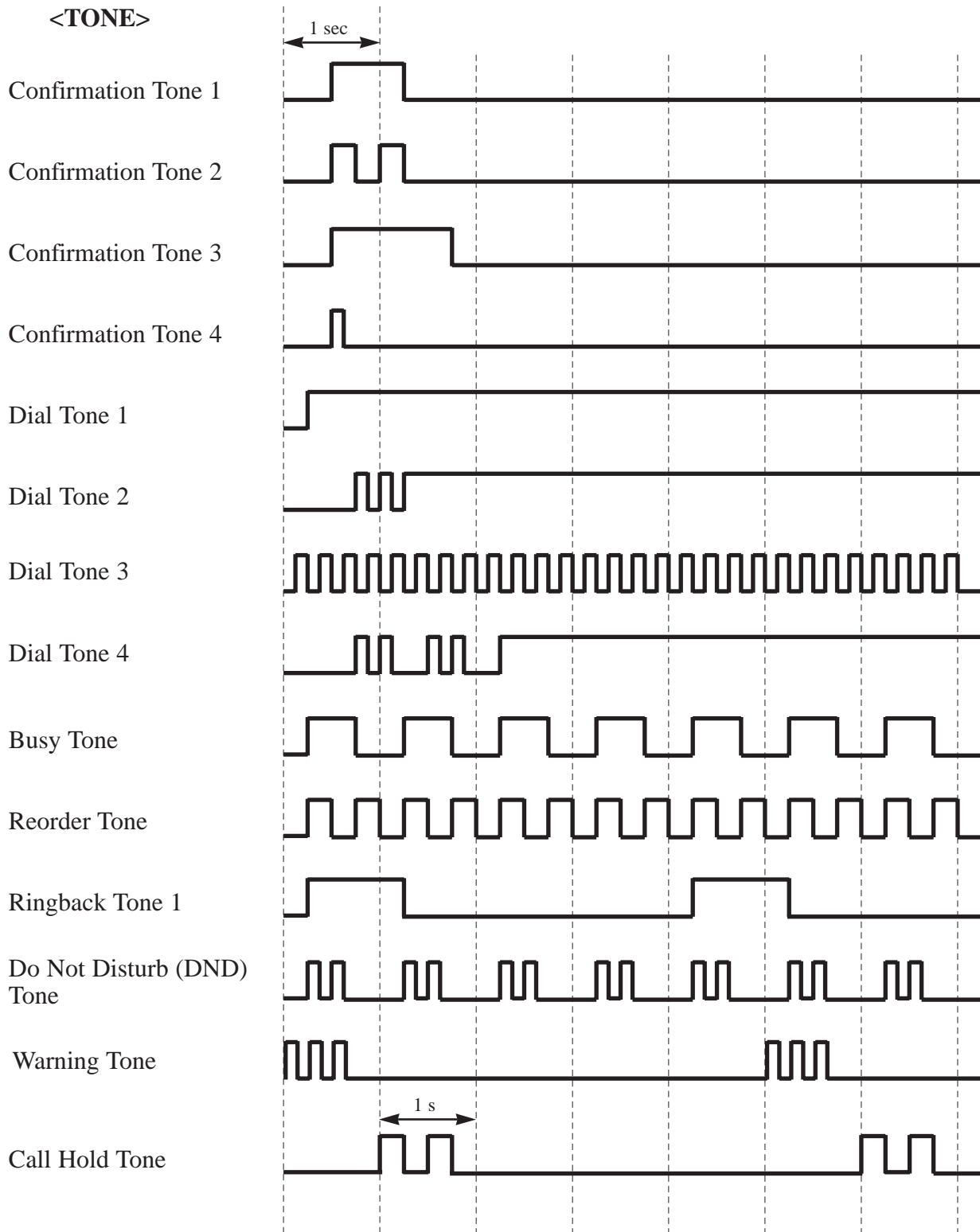

5.1 Tones / Ring Tones

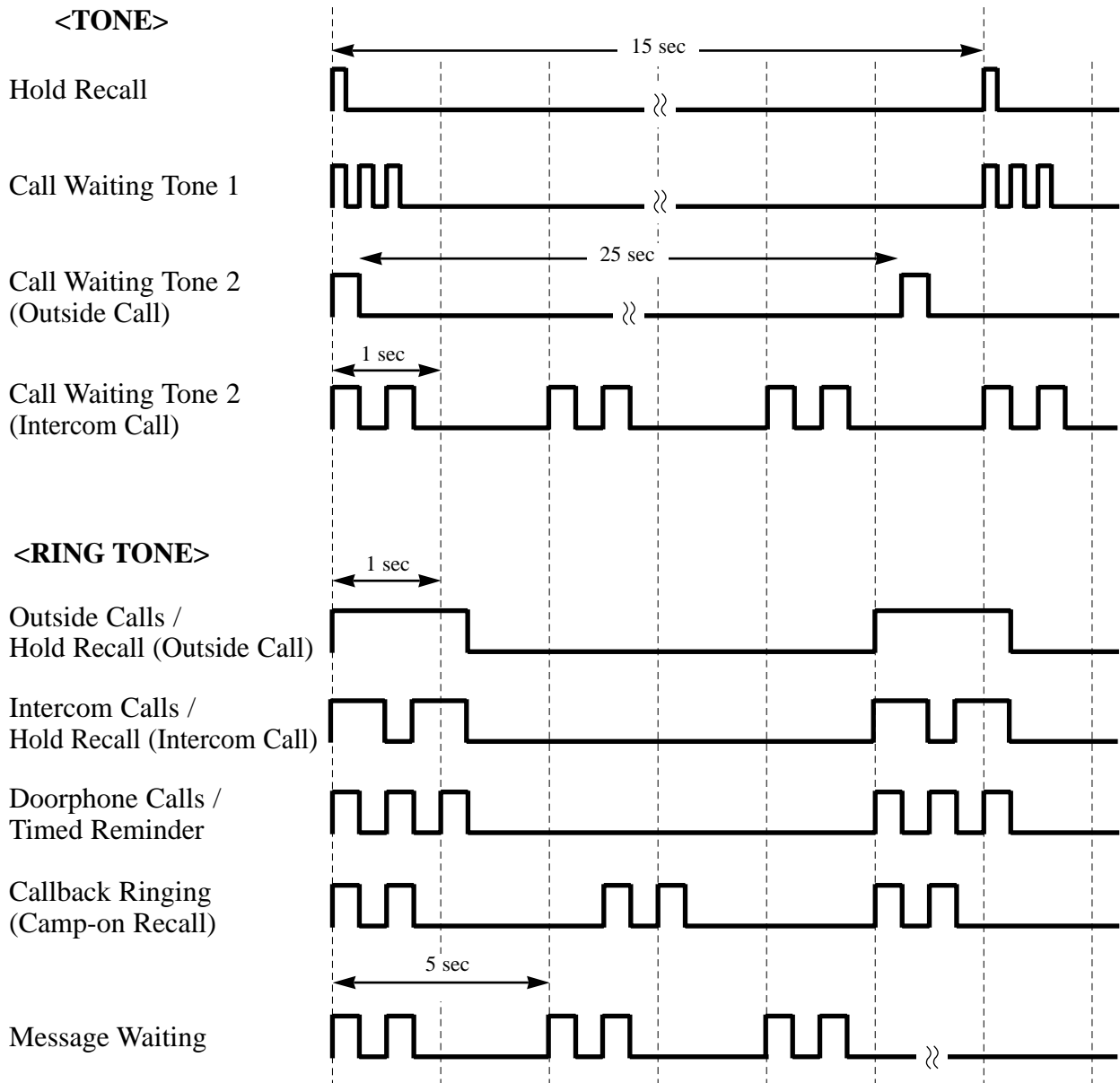

5.1 Tones / Ring Tones



- The confirmation tone and the dial tone vary depending on the conditions as follows:

Confirmation tone 1: (a) When the new setting differs from the previous setting.

(b) Electronic Station Lockout is set or cancelled.

It is possible to eliminate this tone by System Optional Programming.

Confirmation tone 2: (a) When the new setting is identical to the previous setting.

(b) Sent when various features are successfully performed or accessed. (e.g. Call Hold; Automatic Callback Busy)

Confirmation tone 3: Sent when a conversation is established just after dialling.

(e.g. Call Park Retrieve; Call Pickup; Call Hold Retrieve; Paging)

It is possible to eliminate this tone by System Optional Programming.

Confirmation tone 4: Sent when moving from a two-party call to a three-party call, and vice versa. (e.g. Conference) It is possible to eliminate this tone by System Optional Programming.

Dial tone 1 : A normal dial tone. None of the features listed below are enabled.

Dial tone 2 : Sounds when any one of the features below are set.

- | | |
|-------------------------------------|---------------------|
| • Automatic Callback Busy (Camp-On) | • Call Forwarding |
| • Call Pickup Deny | • CLIR |
| • Call Waiting | • COLR |
| • Do Not Disturb (DND) | • DND for DDI |
| • Electronic Station Lockout | • Log-Out |
| • Executive Busy Override Deny | • Pickup Dialling |
| • Paralleled Telephone Connection | • Timed Reminder |
| • BGM | • Paging – Deny |
| • Remote Station Lock Control | • Incoming Call Log |

Dial tone 3 : Sounds when answering the Timed Reminder or in the System Programming mode.

Dial tone 4 : Sounds when messages are waiting for the extension.



- Optional Programming (Section 3.12)
[902] System Additional Information

5.2 LED Indication

The Light Emitting Diode (LED) button indicators provide the line conditions by using lighting patterns.

Flashing light patterns

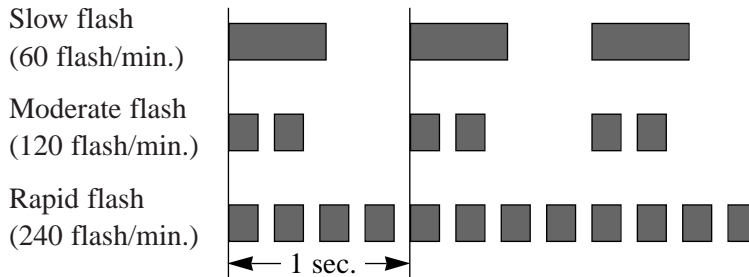

LED Indication on the INTERCOM Button

The table below shows the lighting patterns and the intercom line conditions.

| INTERCOM button | Intercom Line Condition |
|----------------------|--|
| Off | Idle |
| Green on | Intercom call / Conference established |
| Green slow flash | Intercom call hold |
| Green moderate flash | Intercom call exclusive hold / Consultation hold |
| Green rapid flash | Incoming intercom/Doorphone call |

LED Indication on CO Button

The table below shows the lighting patterns and the outside line (CO) conditions.

| CO Button | Outside Line (CO) Condition |
|----------------------|---|
| Off | Idle |
| Green on | You are using the line. |
| Green slow flash | You are holding the line. |
| Green moderate flash | You have exclusive hold / Unattended Conference |
| Green rapid flash | Hold Recall / Incoming call |
| Red on | Another party is using the line. |
| Red slow flash | Another party is holding the line.* |

— The item marked with a * is available for a Single-CO button only.

BLF on DSS Button

The Busy Lamp Field (BLF) indicates the status of the corresponding extension by lighting patterns: Red On/Off. BLF lights red when the corresponding extension is busy or has set the “Do Not Disturb (DND)” feature. BLF is unlit when it is idle. This is available for flexible CO buttons assigned as DSS buttons on proprietary telephones.

5.3 Feature Number List

| FEATURE | NUMBER |
|--|---|
| Account Code Entry before dialling | 49 + account code + # (99) + ISDN port access code + phone no. |
| Absent Message Capability Message 1: Will Return Soon set / cancel Message 2: Gone Home set / cancel Message 3: At Ext %% set / cancel Message 4: Back at %%% set / cancel Message 5: Out until %%% set / cancel Message 6: In a Meeting set / cancel Message 7, 8 and 9: (Programmable) set / cancel | 7501 / 7500 7502 / 7500 7503 + EXTN. / 7500 7504 + hour + minute / 7500 7505 + day + month / 7500 7506 / 7500 7507-9 + parameter / 7500 |
| Automatic Callback Busy (Camp-On) set / cancel | 6 / 46 |
| Busy Station Signalling | 2 |
| Call Forwarding — All Calls set / cancel | 7102 + EXTN. / 7100 |
| Call Forwarding — Busy set / cancel | 7103 + EXTN. / 7100 |
| Call Forwarding — No answer set / cancel | 7104 + EXTN. / 7100 |
| Call Forwarding — Busy/No answer set / cancel | 7105 + EXTN. / 7100 |
| Call Forwarding — To outside line (CO) set / cancel | 7106 + ISDN port access code + phone no. + # / 7100 |
| Call Forwarding — Follow Me set / cancel | 7107 + your EXTN. / 7100 (7108 + your EXTN.) |
| Call Hold place / retrieve / From another – retrieve outside call / intercom call | (RECALL or HOLD) + 50 / 50 / 53 + ISDN port no. / 51 + EXTN. |
| Call Transfer – to ext / to ext after paging | (RECALL or TRNS) + EXTN. / (RECALL or TRNS) + 63+ (0 / extension group no.) |
| CLIR set / cancel / change the setting | 572 / 570 / 571 + ISDN port access code + phone no. |
| Call Park park / retrieve | (RECALL or TRNS) + 52 + parking zone no. / 52 + parking zone no. |
| Call Pickup, outside line (CO) / Directed / Group / from TAM | 4* / 41 + EXTN. / 40 / 42 |
| Call Pickup Deny set / cancel | 7201 / 7200 |
| Call Waiting set / cancel / talk while holding the call | 7311 / 7310 / RECALL + 50 |
| Charge Fee Reference <SLT> – clear the extension charge fee meter – clear the account code charge fee meter – set the new rate – clear all charges except the extension charge – clear all extension charges – print all charges except the extension charge – print all extension charges – print an extension charge – clear the department code charge fee meter | 5*9 + ID code + 1 + EXTN. + # 5*9 + ID code + 4 + account code table no. + # 5*9 + ID code + 5 + ISDN port access code + new rate + # 5*9 + ID code + 61 + # 5*9 + ID code + 62 + # 5*9 + ID code + 71 + # 5*9 + ID code + 72 + # 5*9 + ID code + 73 + EXTN. + # 5*9 + ID code + 9 + department code + # |

5.3 Feature Number List

| FEATURE | NUMBER |
|--|---|
| Charge Fee Reference <PT> – refer to the extension charge fee – clear the extension charge fee meter – refer to the CO charge fee – refer to the total charge fee – refer to the account code charge fee – clear the account code charge fee meter – set the new rate – clear all charges except the extension charge – clear all extension charges – print all charges except the extension charge – print all extension charges – print an extension charge – set the new account code – refer to the department code charge fee – clear the department code charge fee meter | P* + 1 + EXTN. + H* P* + 1 + EXTN. + TRNS + STORE + H* P* + 2 + ISDN port no. + H* P* + 3 + H* P* + 4 + account code table no. + H* P* + 4 + account code table no. + TRNS + STORE + H* P* + 5 + ISDN port no. + new rate + STORE + H* P* + 6 + STORE + H* P* + 6 + SP-PHONE + STORE + H* P* + 71 + H* P* + 72 + H* P* + 73 + EXTN. + H* P* + 8 + account code table no. + TRNS + new account code + STORE + H* P* + 9 + department code + H* P* + 9 + department code + TRNS + STORE + H* |
| CLIP number set – Business use – Private use | 611 612 |
| COLP number set – Business use – Private use | 621 622 |
| COLR set / cancel | 581 / 580 |
| Do Not Disturb (DND) cancel set – forward to the extension / manager / DND | 7100 7101 + EXTN. / 71019 / 7101* |
| Do Not Disturb for Direct Dial In set / cancel | 561 / 560 |
| Do Not Disturb Override | 2 |
| Door Opener unlock / unlock while talking | 55 / (RECALL + 5) or 5 |
| Doorphone Call calling | 68 |
| Electronic Station Lockout lock / unlock | 77 + lock code twice / 77 + lock code |
| Executive Busy Override | 3 |
| Executive Busy Override Deny set / cancel | 7331 / 7330 |
| Incoming Call Log overwriting – set / cancel | 541 / 540 |
| Incoming Call Log Lock – lock / unlock | 59 + lock code twice / 59 + lock code |
| Incoming Call Log Lock Control – clear one extension / all extension | PGM + 9902 + EXTN. + STORE + PGM / PGM + 9902 + * + STORE + PGM |
| ISDN Network Service Access | 795 + ISDN port no. + ISDN service no. |
| Log-In/Log-Out | 451 / 450 |
| Manager Call | 0 |

P* : PROGRAM + 999 + ID code
 H* : HOLD + PROGRAM

5.3 *Feature Number List*

| FEATURE | NUMBER |
|--|--|
| Message Waiting set / cancel / callback / clear | 701 + EXTN. / 700 + EXTN. / 702 / 700 + your EXTN. |
| Night Service auto / manual–day / manual–night / confirm | 780 / 781 / 782 # |
| Outside Calling – Line Access, Automatic – Line Access, Individual | 9 + phone no. (81 or 82) + phone no. |
| Paging – paging all / group – answering the page – transferring after paging all / group – denying the page deny / allow | 63 + 0 / extension group no. 43 (RECALL or TRNS) + 63 + 0 / extension group no. 7211 / 7210 |
| Paralleled Telephone Connection enable / disable | 691 / 690 |
| Pickup Dialling (Hot Line) store / set / cancel | 742 + phone no. + # / 741 / 740 |
| Last Number Redial | #(66) |
| Ring Group | 291 through 298 (floating number of extension group) |
| Station Feature Clear | 790 |
| Station Speed Dialling store | 60 + station speed dial no. + desired no. + # |
| Station Speed Dialling | 6* + station speed dial no. |
| System Speed Dialling | * + system speed dial no. |
| Timed Reminder set–one time / set–daily / cancel / Checking the set time | 761 + hour + minute + 0 / 761 + hour + minute + 1 / 760 / 762 |
| Class of Service (COS) Switch primary / secondary | 791 + EXTN. / 793 + EXTN. |
| Remote Station Lock Control <SLT> unlock / lock | 5*0 + EXTN. + 1 + # / 5*0 + EXTN. + 2 + # |
| Remote Station Lock Control <PT> – unlock one / all extension – lock one / all extension | PGM + 9901 + EXTN./* + 1 + STORE + PGM PGM + 9901 + EXTN./* + 2 + STORE + PGM |

5.4 *Default Values*

| ADDRESS | PROGRAM | DEFAULT |
|------------------------------|--|--|
| Manager Programming | | |
| [000] | Date and Time Set | 1 Jan '99 FRI 00:00 |
| [001] | System Speed Dialling Number Set | Not stored. |
| [002] | Emergency Dial Number Set | Not stored. |
| [003] | Budget Management | 0 (No limitation) |
| System Programming | | |
| [100] | Day/Night Service Starting Time | Every day – Day–9:00 / Night–17:00 |
| [101] | Account Codes | Not stored. |
| [102] | Station Hunting Type | All extension groups – No hunting |
| [103] | System Password | 1234 |
| [104] | Pulse Dial Reception Assignment | Enable |
| [105] | Automatic Door Open Assignment | Both day and night – Disable |
| [107] | Charge Indication Selection | Charge |
| [108] | Charge Verification ID Code Set | 1234 |
| [109] | One-Touch Transfer by DSS Button Set | Enable |
| Timer Programming | | |
| [200] | Hold Recall Time | 60 seconds |
| [201] | Transfer Recall Time | 12 rings |
| [202] | Call Forwarding — No Answer Time | 3 rings |
| [203] | Intercept Time | 12 rings |
| [204] | Pickup Dial Waiting Time | 1 second |
| [205] | DTMF Sending PAUSE Time | 1.5 seconds (1 + 0.5 seconds) |
| [206] | Door Opener Time | 5 seconds |
| [207] | Message Waiting Ring Interval Time | 10 minutes |
| [208] | Automatic Redial Repeat Time | 4 times |
| [209] | Automatic Redial Interval Time | 120 (12 x 10) seconds |
| TRS Programming | | |
| [300]–[304] | TRS Denied Code Entry for Levels 2 through 6 | All locations – Not stored. |
| [305]–[309] | TRS Excepted Code Entry for Levels 2 through 6 | All locations – Not stored. |
| ISDN Port Programming | | |
| [400] | ISDN Port Connection Assignment | ISDN port 1 – Connect / ISDN port 2 – Not connect |
| [401]–[402] | Intercept Extension — Day/Night | All ISDN ports – Disable (Day/Night) |
| [403] | Host PBX Access Codes | All ISDN ports – Not stored. |
| [404] | CLIP/COLP Number Assignment | All CLIP/COLP numbers – Not stored. |
| [405] | Direct Dialling In | All ISDN ports – Enable |
| [406] | ISDN Configuration | All ISDN ports – Outside Line (CO) / Point-to-multi-point |
| [407] | Multiple Subscriber Number Set | All ISDN Ports – All locations – Not stored. |

5.4 *Default Values*

| ADDRESS | PROGRAM | DEFAULT |
|------------------------------|---|--|
| [408]–[409] | Extension Ringing Assignment — Day/Night for ISDN | All locations – All extensions – Immediate ringing (Day/Night) |
| [410]–[411] | ISDN Extension Ringing Assignment — Day/Night for ISDN | All ISDN Ports – All locations – Not stored. (Day/Night) |
| [412] | ISDN DDI Number/Extension Number Transformation | All DDI numbers – Not stored. |
| COS Programming | | |
| [500]–[501] | Toll Restriction Level — Day/Night | All COS – Level 1 (Day/Night) |
| [503] | Call Forwarding to outside line (CO) | All COS – Enable |
| [504] | Do Not Disturb Override | All COS – Disable |
| [505] | Account Code Entry Mode | All COS – Option mode |
| [506]–[507] | Toll Restriction Level for System Speed Dialling — Day/Night | All COS – Level 1 (Day/Night) |
| [508] | Door Opener Access | All COS – Enable |
| [509] | Night Service Access | All COS – Enable |
| [510] | Do Not Disturb for Direct Dialling In Call | All COS – Disable |
| [511] | Call Forwarding — Follow Me | All COS – Enable |
| [512] | Calling Line Identification Restriction (CLIR) | All COS – Disable |
| [513] | Connected Line Identification Restriction (COLR) | All COS – Disable |
| [514] | Executive Busy Override | All COS – Disable |
| [515] | Executive Busy Override Deny | All COS – Enable |
| [517] | Call Forwarding by ISDN Service | All COS – Disable |
| Extension Programming | | |
| [600] | Extra Device Port | All extensions (21 through 24) – Disable |
| [601] | Class of Service | All extensions – COS 1 |
| [602] | Extension Group Assignment | All extensions – Extension group 1 |
| [603]–[604] | DIL 1:N Extension and Delayed Ringing — Day/Night | All extensions – All ISDN ports – Immediate ringing (Day/Night) |
| [605]–[606] | Outgoing Permitted ISDN Port Assignment — Day/Night | All extensions – All ISDN Ports – Enable (Day/Night) |
| [607]–[608] | Doorphone Ringing Assignment —Day/Night | Extension 21 – Enable (Day/Night); Other extensions – Disable (Day/Night) |
| [609] | Extension Connection Assignment | All extensions – Connect |
| [610] | IRNA Assignment | All extensions – Enable |
| [611] | TAM Connection Assignment | All extensions – Disable |
| [612] | Data Line Security | All extensions – Disable |
| [613] | Department Codes | All extensions – Not stored. |
| [614]–[615] | Doorphone Call Forwarding — Day/Night | Not stored. |

5.4 *Default Values*

| ADDRESS | PROGRAM | DEFAULT |
|-----------------------------|--|--|
| ARS Programming | | |
| [700] | ARS Mode | Both ISDN ports – Disable |
| [701] | ARS Carrier Code | All routes – Not stored. |
| [702] | ARS Route Selection Code | All routes – All area numbers – Not stored. |
| [703] | ARS Authorization Code | All routes – All ISDN ports – Not stored. |
| [704] | ARS Itemized Bill Code | All routes – All ISDN ports – Not send. |
| [705] | 1st Carrier Access Code | Not stored. |
| [706] | ARS Route Exceptional Code | All routes – All area numbers – Not stored. |
| [708] | ARS Modify Removed Digit | All routes – 0 digit (no deletion) |
| [709] | ARS Modify Added Number | All routes – Not stored. |
| Resource Programming | | |
| [800] | SMDR Incoming/Outgoing Call Log Printout | Outgoing calls/Incoming calls – No printing |
| [801] | SMDR Format | Page length – 66 lines; Skip perforation – 0 line |
| [802] | System Data Printout | Not applicable. |
| [803] | Music Source Use | Both – Music source |
| [804] | Serial Interface (RS-232C) Parameters | New line code – CR+LF; Baud rate – 9600 baud; Word length – 8 bits; Parity – None; Stop bits – 1 bit |
| Optional Programming | | |
| [900] | System Data All Clear | Not applicable. |
| [901] | System Data Clear Except ISDN Data | Not applicable. |
| [902] | System Additional Information | See pages 2-55 through 2-57. |
| [903] | Received Number Check | Not applicable. |

5.5 Specifications

4.5.1 General Description

| | | | |
|------------------------|-------------------------|---|--|
| System Capacity | Basic System | Extension lines | 8 |
| | | ISDN line | 1 (2 CO lines) |
| | Expansion | ISDN line | 1 (either for 8 extension lines or 2 CO lines) |
| | Maximum Capacity | When an optional ISDN line is used for CO lines: | |
| | | Extension lines | 8* |
| | | CO lines | 4 |
| | | When an optional ISDN line is used for extension lines: | |
| | | Extension lines | 8* |
| | | ISDN extension lines | 8 |
| | | CO lines | 2 |

*A DPT can be connected to an extension jack numbered 21-24. Each DPT can support an SLT by XDP connection.

Control Method Stored Program CPU: 8 bits CPU
Control ROM: 1024 KB, Control RAM: 160 KB

Switching Non Blocking PCM Time Sharing Switch

Power Supplies Primary 110 – 240 VAC, 50/60 Hz
Secondary Circuit Volt: + 5V, + 15V, + 30V

Dialling Dial Pulse (DP) 10 pps, 20 pps, Tone (DTMF) Dialling, DTMF-DP

Connector ISDN lines Modular connector (8-pin)
Extensions 4-pin connector
Doorphone 4-pin connector

Extension Connection Cable

| | |
|--|---|
| Single line telephones | 1 pair wire (T, R) |
| KX-T7230, KX-T7235, KX-T7250, KX-T7425, KX-T7433, KX-T7436, KX-T7450 | 1 pair wire (D1, D2) or 2 pair wire (T, R, D1, D2) for XDP |

SMDR (Station Message Detail Recording)

Interface EIA (RS-232C) (D-SUB, 9-pin)
Output Equipment Printer
Recording Details Date, Time, Extension Number, Department Code,
ISDN Port Number, Dial Number, Call Duration,
Charge Fee, Account Code, Condition Code

5.5 Specifications

4.5.2 Characteristics

| | |
|---|--|
| Station Loop Limit | KX-T7230/KX-T7235/KX-T7250/KX-T7425/ KX-T7433/KX-T7436/KX-T7450.....40 ohms Single Line Telephone600 ohms including set Doorphone.....20 ohms |
| Minimum Leak Resistance | 15 000 ohms |
| Maximum Number of Station Instruments per Line | 1 unit for KX-T7230, KX-T7235, KX-T7250, KX-T7425, KX-T7433, KX-T7436, KX-T7450 or a single line telephone. 2 units by Parallel or an EXtra Device Port connection (a proprietary telephone and a single line telephone). |
| Ring Voltage | 90 Vrms at 25 Hz depends on the Ringing Load |
| Primary Power | 110 – 240 VAC, 50/60 Hz |
| Central Office Loop Limit | 1 600 ohms max. |
| Environmental Requirements | 0 – 40 °C, 10 – 90% |

4.5.3 System Capacity

Lines, Cards, Station Equipment

| Item | Max. Quantity |
|--------------------------|---------------|
| Service Unit | 1 |
| ISDN Line Expansion card | 1 |
| ISDN Line | 2 |
| Extension Jack | 8 |
| Station Terminal | 20 |
| Doorphone | 1 |
| Door Opener | 1 |

System Data

| Item | Max. Quantity |
|---------------------------|------------------|
| Manager | 1 (Ext. 21) |
| System Speed Dialling | 100 |
| Station Speed Dialling | 10 per extension |
| Call Park | 10 |
| Toll Restriction Level | 8 |
| Extension Group | 8 |
| Class of Service | 4 |
| Ring Group | 8 |
| Uniform Call Distribution | 8 |

5.6 Troubleshooting

4.6.1 Installation and Operation

| PROBLEM | PROBABLE CAUSE | POSSIBLE SOLUTION |
|--|--|--|
| Extension does not operate. | <p>Bad printed circuit board (Extension Card).</p> <p>Bad connection between the system and extension.</p> <p>Bad extension.</p> | <p>Exchange the printed circuit board with another printed circuit board.</p> <p>Take that extension and plug it into the same extension port using a short telephone cord. If the telephone does not work, the connection between the system and the extension must be repaired.</p> <p>Take that extension and plug it into another extension port that is working correctly. If the telephone does not work, replace the phone.</p> |
| Improper operation. | | <p>Press the Reset Switch.</p> <p>System restart causes the following:</p> <ul style="list-style-type: none"> • Camp-On is cleared. • Call Park is cleared. • Calls on hold are terminated. • Calls in progress are terminated. <p>All other data stored in memory, except the above, is secured.</p> |
| Speed Dialling does not function. | Incorrect programming. | Enter the ISDN port access number (9, 81 or 82) into programming. |
| A power failure occurs and all the lines are disconnected. | The KX-TD208 does not work during a power failure. | Disconnect the ISDN telephone unit from the system and connect it directly to the ISDN line. Then you can make an outside call. A SLT cannot be used during a power failure. |
| Your single line rotary telephone does not function. | The pulse dial from your telephone is disabled by the system. | Select "Enable" in program [104] "Pulse Dial Reception Assignment." |
| You forgot your own extension number. | | <p>You can confirm your own extension number if your telephone is provided with a display.</p> <p>Press [PROGRAM][99][6].</p> <p>To exit from the mode, press [HOLD][PROGRAM].</p> |

5.6 Troubleshooting

4.6.2 Connection

Connection between the KX-TD208 and a single line telephone:

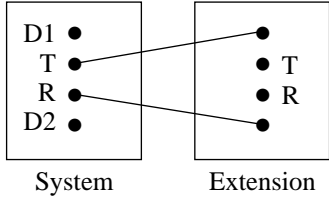
| | | | |
|----------------------------|----|--|--|
| Can you dial an extension? | No | CAUSE | SOLUTION |
| | | <p>T/R is connected to D1/D2.</p>  <p style="text-align: center;">System Extension</p> | <p>Use the correct cord (inner 2 wires are for T/R).</p> |

Connection between the KX-TD208 and a single line telephone that is polarity-sensitive:

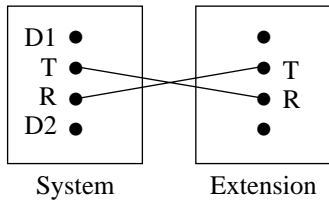
| | | | |
|-----|----|---|------------------------------------|
| Yes | No | CAUSE | SOLUTION |
| | | <p>“T” is connected to “R.”</p>  <p style="text-align: center;">System Extension</p> | <p>Reverse the T/R connection.</p> |

Connection between the central office and the system:

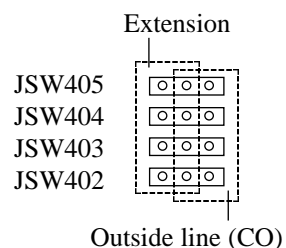
| | | | |
|--|----|---|---|
| Can you dial out on a outside line (CO)? | No | CAUSE | SOLUTION |
| | | <ul style="list-style-type: none"> • A straight type ISDN line cord was used for outside line (CO) connection. • The adjustment of the extension/outside line (CO) switch socket is reversed. | <ul style="list-style-type: none"> • Reconnect the CO lines with a cross type ISDN line cord. • Adjust the extension/outside line (CO) switch socket as follows:  <p style="text-align: center;">Extension</p> <p style="text-align: center;">JSW405 JSW404 JSW403 JSW402</p> <p style="text-align: center;">Outside line (CO)</p> |

5.7 *Template*

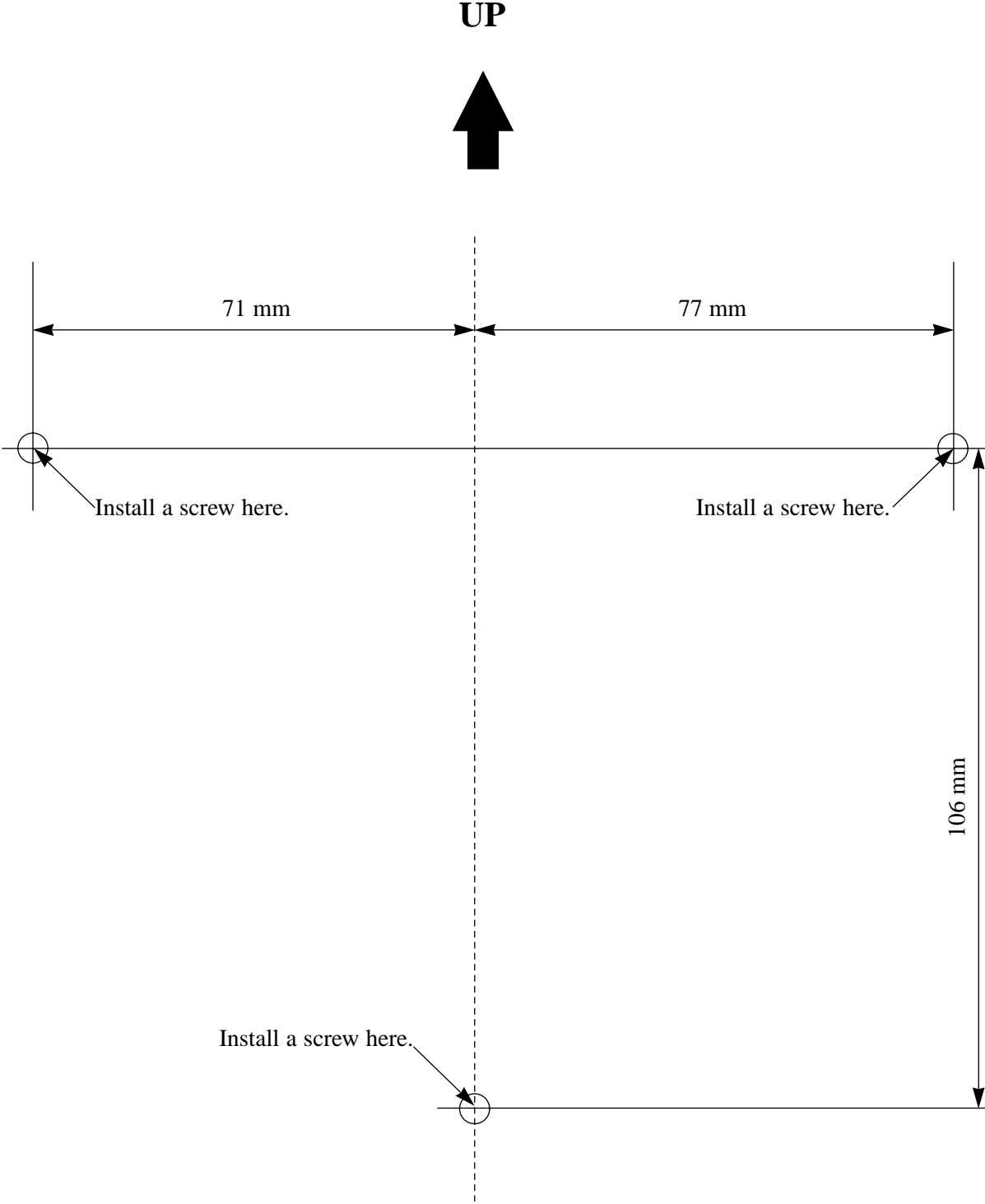

- Copy the template and place it on the wall before mounting the main unit.

Kyushu Matsushita Electric Co., Ltd.

1-62, 4-chome, Minoshima, Hakata-ku, Fukuoka 812-8531, Japan

Printed in Japan

PSQX1802ZA KK0799KM0