

RoHS Compliant Product

Description

The SID9971 provide the designer with the best combination of fast switching, ruggedized device design, low on-resistance and cost-effectiveness.

The TO-251 is universally preferred for all commercial-industrial surface mount applications and suited for low voltage applications such as DC/DC converters.

Features

- * Low On-Resistance
- * Simple Drive Requirement

TO-251

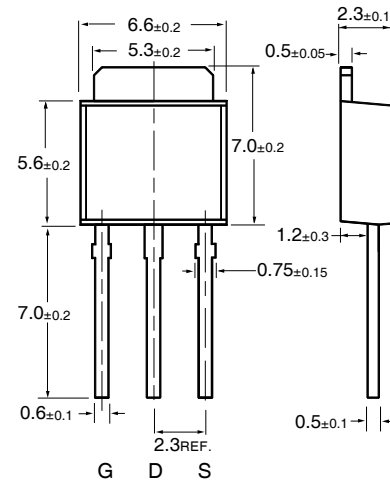

Dimensions in millimeters

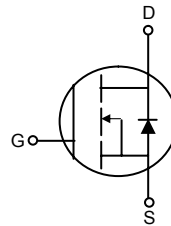

Marking Code: 9971

XXXX(Date Code)

Absolute Maximum Ratings

Parameter	Symbol	Ratings	Unit
Drain-Source Voltage	V_{DS}	60	V
Gate-Source Voltage	V_{GS}	± 20	V
Continuous Drain Current, $V_{GS}@10V$	$I_D@T_C=25^{\circ}C$	25	A
Continuous Drain Current, $V_{GS}@10V$	$I_D@T_C=100^{\circ}C$	16	A
Pulsed Drain Current ¹	I_{DM}	80	A
Total Power Dissipation	$P_D@T_C=25^{\circ}C$	39	W
Linear Derating Factor		0.31	W/°C
Operating Junction and Storage Temperature Range	T_j, T_{stg}	-55~+150	°C

Thermal Data

Parameter	Symbol	Ratings	Unit
Thermal Resistance Junction-case	R_{thj-c}	3.2	°C/W
Thermal Resistance Junction-ambient	R_{thj-a}	110	°C/W

Electrical Characteristics(T_j=25°C Unless otherwise specified)

Parameter	Symbol	Min.	Typ.	Max.	Unit	Test Condition
Drain-Source Breakdown Voltage	BV _{DSS}	60	-	-	V	V _{GS} =0V, I _D =250μA
Breakdown Voltage Temp. Coefficient	ΔBV _{DSS} /ΔT _j	-	0.05	-	V/°C	Reference to 25°C, I _D =1mA
Gate Threshold Voltage	V _{GS(th)}	1.0	-	3.0	V	V _{DS} =V _{GS} , I _D =250μA
Gate-Source Leakage Current	I _{GSS}	-	-	±100	nA	V _{GS} =±20V
Drain-Source Leakage Current (T _j =25°C)	I _{DSS}	-	-	1	μA	V _{DS} =60V, V _{GS} =0
Drain-Source Leakage Current(T _j =150°C)		-	-	25	μA	V _{DS} =48V, V _{GS} =0
Static Drain-Source On-Resistance	R _{DS(ON)}	-	-	36	mΩ	V _{GS} =10V, I _D =18A
		-	-	50		V _{GS} =4.5V, I _D =12A
Total Gate Charge ²	Q _g	-	18	30	nC	I _D =18A V _{DS} =48V V _{GS} = 4.5V
Gate-Source Charge	Q _{gs}	-	6	-		
Gate-Drain ("Miller") Charge	Q _{gd}	-	11	-		
Turn-on Delay Time ²	T _{d(ON)}	-	9	-	nS	V _{DD} =30V I _D =18A V _{GS} =10V R _G =3.3Ω R _D =1.67Ω
Rise Time	T _r	-	24	-		
Turn-off Delay Time	T _{d(OFF)}	-	26	-		
Fall Time	T _f	-	7	-		
Input Capacitance	C _{iss}	-	1700	2700	pF	V _{GS} =0V V _{DS} =25V f=1.0MHz
Output Capacitance	C _{oss}	-	160	-		
Reverse Transfer Capacitance	C _{rss}	-	110	-		
Forward Transconductance	G _{fs}	-	17	-	S	V _{DS} =10V, I _D =18A

Source-Drain Diode

Parameter	Symbol	Min.	Typ.	Max.	Unit	Test Condition
Forward On Voltage ²	V _{SD}	-	-	1.2	V	I _S =25 A, V _{GS} =0V.
Reverse Recovery Time	T _{rr}	-	37	-	nS	I _S =18A, V _{GS} =0V. dI/dt=100A/μs
Reverse Recovery Charge	Q _{rr}	-	38	-	nC	

Notes: 1.Pulse width limited by safe operating area.

2.Pulse width ≤300μs, dutycycle≤2%.

Characteristics Curve

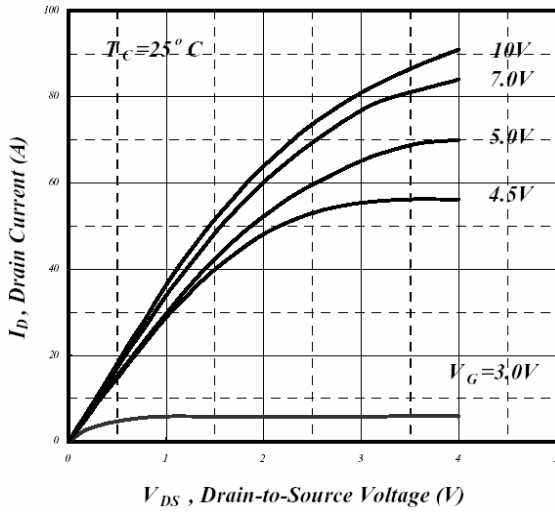

Fig 1. Typical Output Characteristics

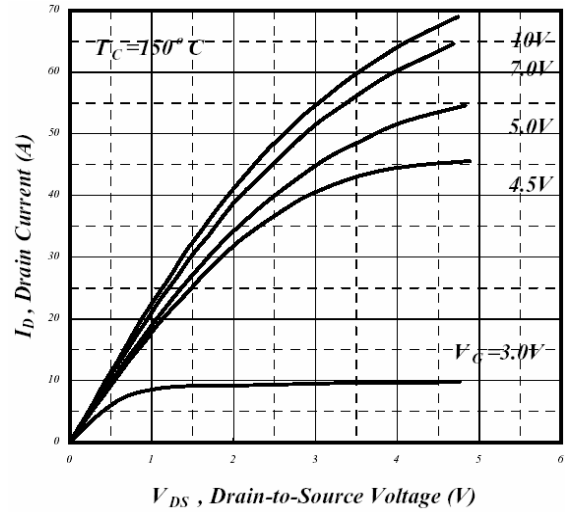

Fig 2. Typical Output Characteristics

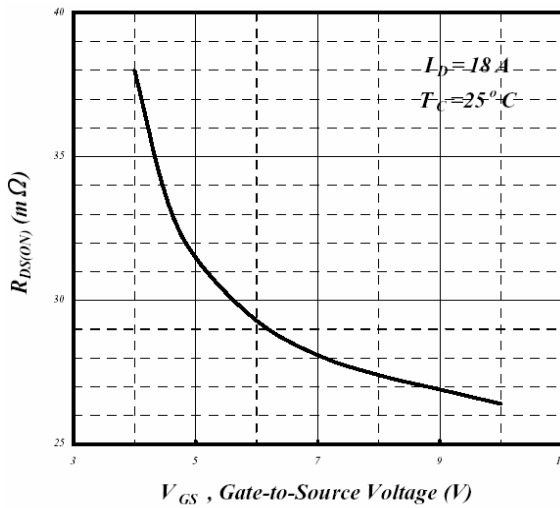

Fig 3. On-Resistance v.s. Gate Voltage

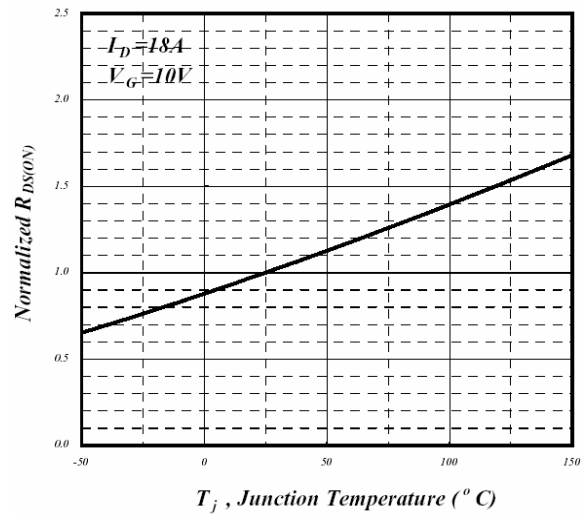

Fig 4. Normalized On-Resistance v.s. Junction Temperature

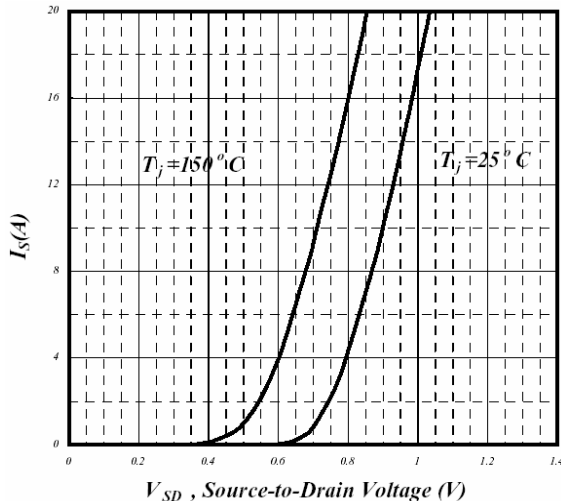

Fig 5. Forward Characteristics of Reverse Diode

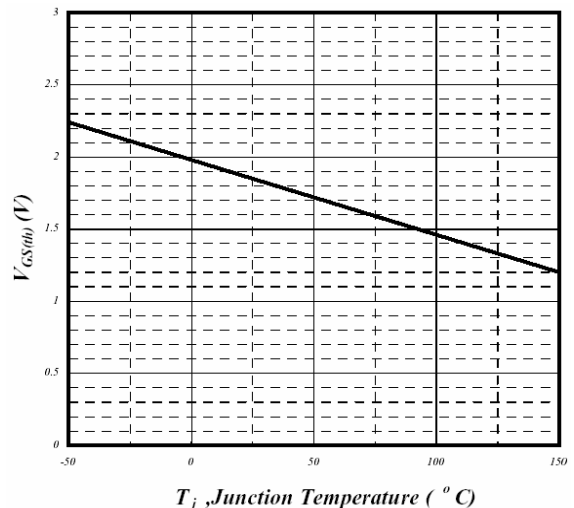

Fig 6. Gate Threshold Voltage v.s. Junction Temperature

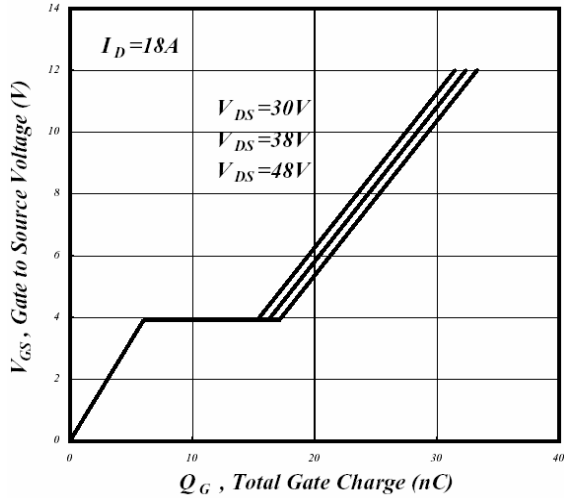

Fig 7. Gate Charge Characteristics

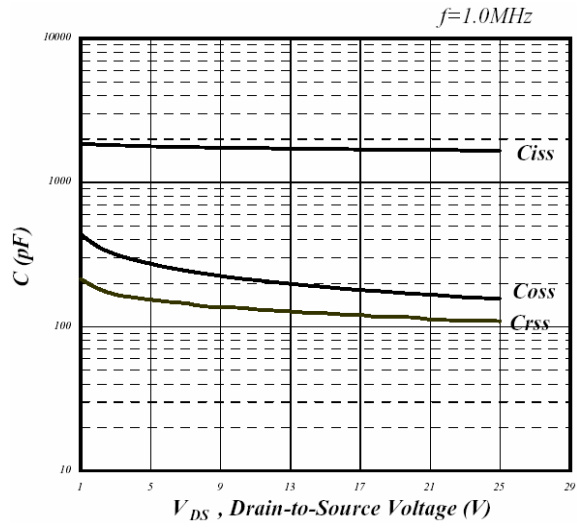

Fig 8. Typical Capacitance Characteristics

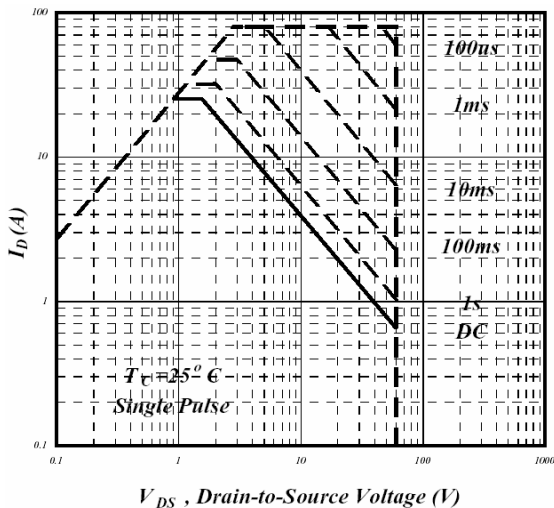

Fig 9. Maximum Safe Operating Area

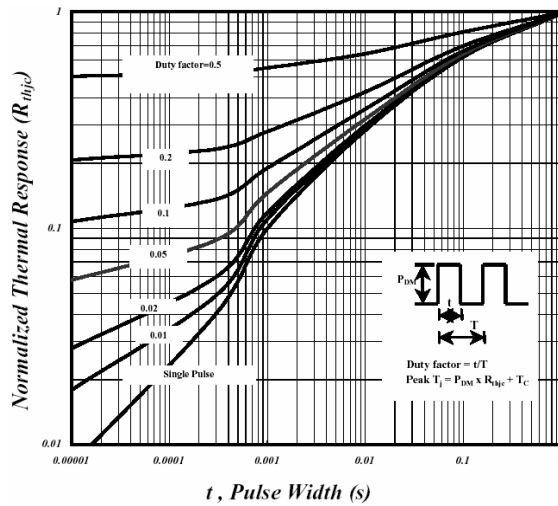

Fig 10. Effective Transient Thermal Impedance

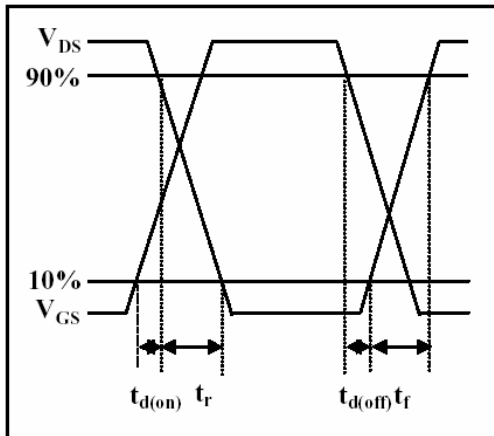

Fig 11. Switching Time Waveform

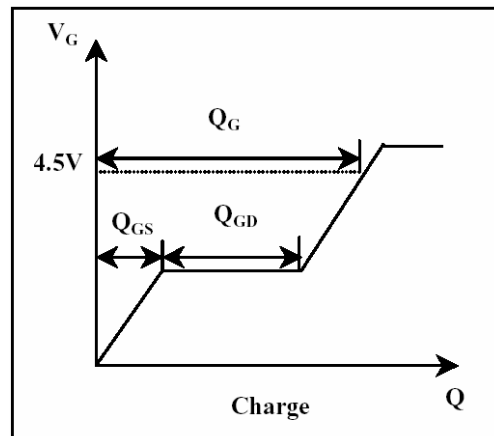

Fig 12. Gate Charge Waveform