

PLEASE CHECK WWW.MOLEX.COM FOR LATEST PART INFORMATION

Part Number: [0559351330](#)
Status: **Active**
Overview: microclasp
Description: 2.00mm (.079") Pitch MicroClasp™ Wire-to-Board Header, Single Row, Right Angle, 13 Circuits, without PCB Locator

Documents:

[3D Model](#) [Product Specification PS-51382-004 \(PDF\)](#)
[Drawing \(PDF\)](#) [RoHS Certificate of Compliance \(PDF\)](#)

General

Product Family	PCB Headers
Series	55935
Application	Wire-to-Board
Overview	microclasp
Product Name	MicroClasp™

Physical

Breakaway	No
Circuits (Loaded)	13
Circuits (maximum)	13
Color - Resin	Natural
Durability (mating cycles max)	30
First Mate / Last Break	No
Glow-Wire Compliant	No
Guide to Mating Part	No
Keying to Mating Part	None
Lock to Mating Part	Yes
Material - Plating Mating	Tin
Material - Plating Termination	Tin
Material - Resin	Polyester
Number of Rows	1
Orientation	Right Angle
PC Tail Length (in)	0.126 In
PC Tail Length (mm)	3.20 mm
PCB Locator	No
PCB Retention	Yes
PCB Thickness Recommended (in)	0.062 In
PCB Thickness Recommended (mm)	1.60 mm
Packaging Type	Tray
Pitch - Mating Interface (in)	0.079 In
Pitch - Mating Interface (mm)	2.00 mm
Shrouded	Fully
Stackable	No
Surface Mount Compatible (SMC)	No
Temperature Range - Operating	-25°C to +85°C
Termination Interface: Style	Through Hole

Electrical

Current - Maximum per Contact	3A
Voltage - Maximum	250V

Material Info

Reference - Drawing Numbers

Packaging Specification	SPK-55935-001
-------------------------	---------------

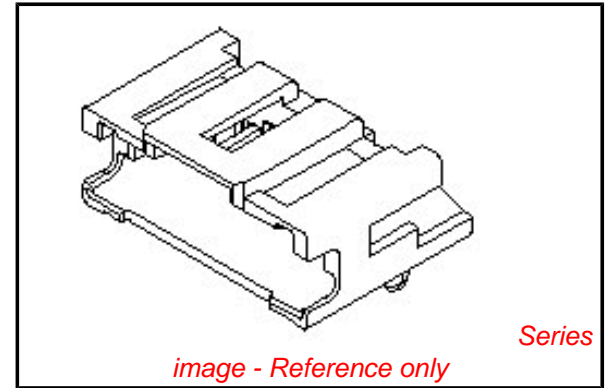

EU RoHS

**ELV and RoHS
Compliant**
**REACH SVHC
Contains SVHC: No**
**Halogen-Free
Status**

China RoHS



Not Reviewed

**Need more information on product
environmental compliance?**

Email productcompliance@molex.com
For a multiple part number RoHS Certificate of Compliance, [click here](#)

Please visit the [Contact Us](#) section for any non-product compliance questions.

Search Parts in this Series

[55935Series](#)

Mates With

[51382 MicroClasp™ Wire-to-Board Receptacle Housing](#)

Product Specification

PS-51382-004, RPS-51382-006, RPS-51382-007,
RPS-51382-008, RPS-51382-009, RPS-51382-010,
RPS-51382-012, RPS-51382-013, RPS-51382-014,
RPS-51382-015
SD-55935-002

Sales Drawing

This document was generated on 05/25/2010

PLEASE CHECK WWW.MOLEX.COM FOR LATEST PART INFORMATION

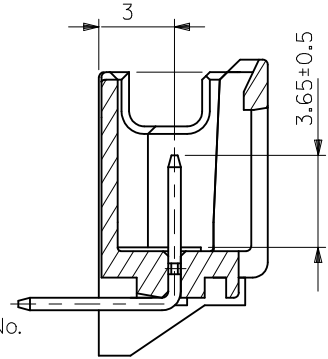
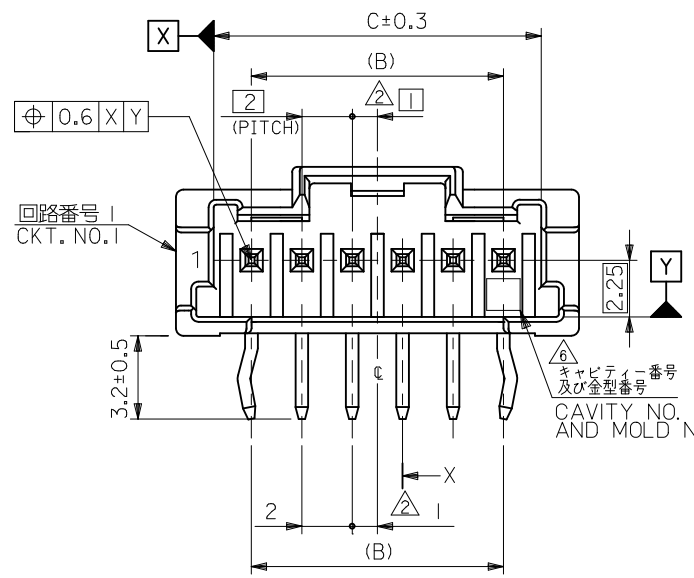

NOTE
 1. 嵌合相手: 51382-****
 2. 偶数極(列)に適用。
 3. キングは両外側の位置に付加。
 4. 製品番号 MATERIAL NO.
55935-****
 極数 CIRCUIT SIZE

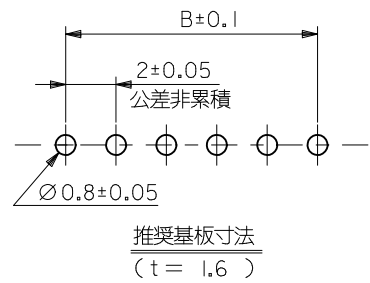

6. キャビティ番号 : 1~2桁の数字
 金型番号 : アルファベット1文字にて構成
 (例 1A, 10B)
 尚、金型番号は刻印無しの製品あり。
 FORMED BY 1 DIGIT TO " DIGIT
 NUMBERS (TO CAVITY No.)
 AND BY 1 LETTER OF ALPHABET.
 (TO MOLD No.)
 (e.g. 1A,10B)
 THERE ARE PRODUCTS WITHOUT
 THE MARK OF MOLD No.

色 COLOR	色 COLOR
30 自然色(白) NATURAL(WHITE)	30 自然色(白) NATURAL(WHITE)
31 黒 BLACK	31 黒 BLACK
32 赤 RED	32 赤 RED
33 黄 YELLOW	33 黄 YELLOW
34 青 BLUE	34 青 BLUE
35 桃 PINK	35 桃 PINK
36 緑 GREEN	36 緑 GREEN
37 茶 BROWN	37 茶 BROWN
38 橙 ORANGE	38 橙 ORANGE
39 紫 VIOLET	39 紫 VIOLET
51 灰 GRAY	51 灰 GRAY
53 蛍光黄 FLUORESCENT YELLOW	53 蛍光黄 FLUORESCENT YELLOW
54 水 PALE BLUE	54 水 PALE BLUE
55 蛍光桃 FLUORESCENT PINK	55 蛍光桃 FLUORESCENT PINK
56 黄緑 YELLOWISH GREEN	56 黄緑 YELLOWISH GREEN
58 蛍光橙 FLUORESCENT ORANGE	58 蛍光橙 FLUORESCENT ORANGE

31	28	34	55935-15**	15
29	26	32	55935-14**	14
27	24	30	55935-13**	13
25	22	28	55935-12**	12
23	20	26	55935-11**	11
21	18	24	55935-10**	10
19	16	22	55935-09**	9
17	14	20	55935-08**	8
15	12	18	55935-07**	7
13	10	16	55935-06**	6
11	8	14	55935-05**	5
9	6	12	55935-04**	4
7	4	10	55935-03**	3
5	2	8	55935-02**	2
C	B	A	MATERIAL NO.	CKT.

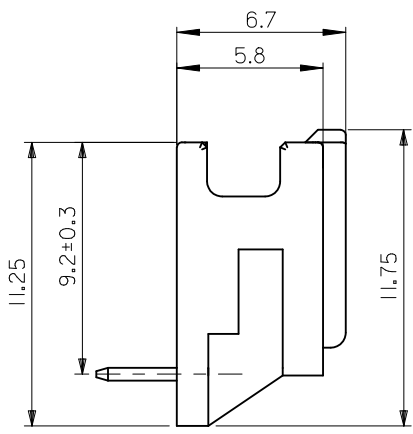
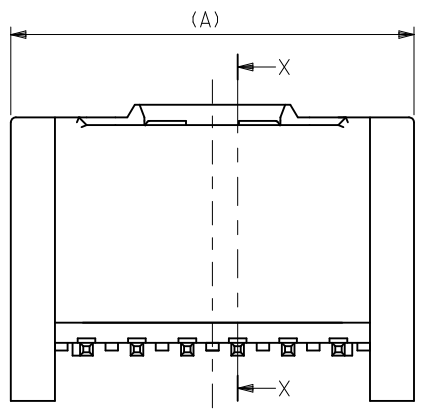

5. トレードマーク: Mプラス1~2文字のアルファベットにて構成。(例: MXJ)
 但し、"J"はJAPANを示す。
 FORMED BY M AND 1-2 MORE LETTER OF ALPHABET (e.g. MXJ) TO TRADE MARK. BUT "J" SHOW JAPAN.

4. トレードマーク TRADE MARK

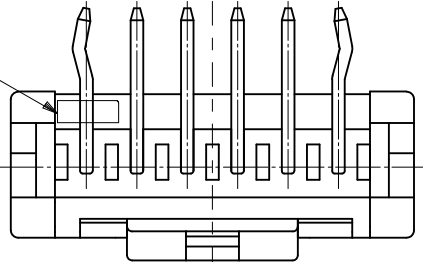

MATERIAL
 ピン : 黄銅、ニッケル下地錫メッキ
 ハウジング : PBT

REVISED EC NO.: J2010-2139 DRWN: THANU 2010/04/26 CHKD: ASAKAWA 2010/04/26 APPR: NUKITA 2010/04/27 K	DESCRIPTION REV	GENERAL TOLERANCES (UNLESS SPECIFIED)		DIMENSION STYLE MM ONLY		SCALE ---	DESIGN UNITS METRIC	THIRD ANGLE PROJECTION		
		10 UNDER	±0.2	DRAWN BY T. NIITSU	DATE '02/02/08	TITLE 2.0 W/B SINGLE CONN. PLUG HOUSING ASS'Y R/A -LEAD FREE-				
		10 OVER 30 UNDER	±0.25	CHECKED BY K. ASAKAWA	DATE '03/06/12	MOLEX INCORPORATED				
		30 OVER	±0.3	APPROVED BY T. YAMAGUCHI	DATE '03/06/12	DOCUMENT NO. SD-55935-002				
		ANGULAR	±3 °	MATERIAL NO. SEE CHART		SHEET NO. 1 OF 2				
		DRAFT WHERE APPLICABLE MUST REMAIN WITHIN DIMENSIONS			THIS DRAWING CONTAINS INFORMATION THAT IS PROPRIETARY TO MOLEX INCORPORATED AND SHOULD NOT BE USED WITHOUT WRITTEN PERMISSION					

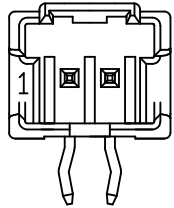
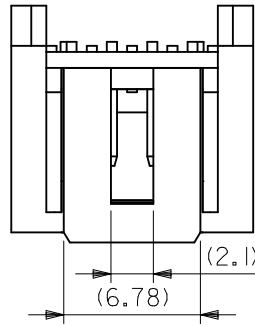
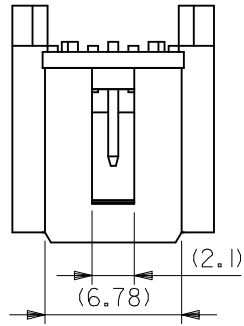
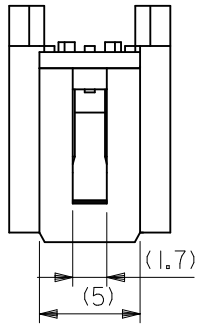

2 CIRCUIT

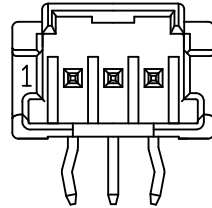

3 CIRCUIT

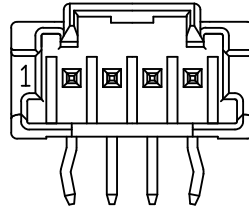

4 CIRCUIT 以上

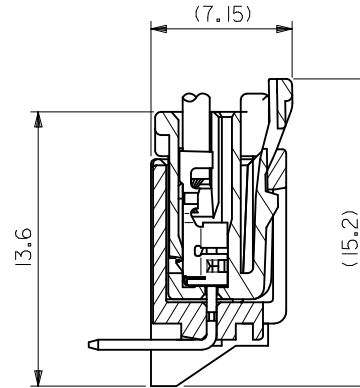

嵌合断面图

MODEL NO. : 55935-****

REVISED EC NO: J2010-2139 DRWN: THANU 2010/04/26 CHK'D: ASAKAWA 2010/04/26 APPR: NUKITA 2010/04/27 K	DESCRIPTION REV	GENERAL TOLERANCES (UNLESS SPECIFIED)		DIMENSION STYLE MM ONLY		SCALE ---	DESIGN UNITS METRIC	THIRD ANGLE PROJECTION		
		10 UNDER	±0.2	DRAWN BY T. NIITSU	DATE '02/02/08	TITLE 2.0 W/B SINGLE CONN. PLUG HOUSING ASS'Y R/A -LEAD FREE-				
		10 OVER 30 UNDER	±0.25	CHECKED BY K. ASAKAWA	DATE '03/06/12	MOLEX INCORPORATED				
		30 OVER	±0.3	APPROVED BY T. YAMAGUCHI	DATE '03/06/12	MATERIAL NO. SEE CHART		DOCUMENT NO. SD-55935-002	SHEET NO. 2 OF 2	
		ANGULAR ±3 °	DRAFT WHERE APPLICABLE MUST REMAIN WITHIN DIMENSIONS		THIS DRAWING CONTAINS INFORMATION THAT IS PROPRIETARY TO MOLEX INCORPORATED AND SHOULD NOT BE USED WITHOUT WRITTEN PERMISSION					