

DATA SHEET

PCF84C12A; PCF84C22A; PCF84C42A 8-bit microcontrollers

Product specification
Supersedes data of 1996 Apr 04
File under Integrated Circuits, IC14

1996 Nov 20

8-bit microcontrollers**PCF84C12A; PCF84C22A;
PCF84C42A**

CONTENTS

1	FEATURES
2	GENERAL DESCRIPTION
3	ORDERING INFORMATION
4	BLOCK DIAGRAM
5	PINNING INFORMATION
5.1	Pinning
5.2	Pin description
6	INSTRUCTION SET
7	ROM MASK OPTIONS
8	HANDLING
9	LIMITING VALUES
10	DC CHARACTERISTICS
11	AC CHARACTERISTICS
12	PACKAGE OUTLINES
13	SOLDERING
13.1	Introduction
13.2	DIP
13.2.1	Soldering by dipping or by wave
13.2.2	Repairing soldered joints
13.3	SO
13.3.1	Reflow soldering
13.3.2	Wave soldering
13.3.3	Repairing soldered joints
14	DEFINITIONS
15	LIFE SUPPORT APPLICATIONS

8-bit microcontrollers

PCF84C12A; PCF84C22A;
PCF84C42A**1 FEATURES**

- Manufactured in silicon gate CMOS process
- 8-bit CPU, ROM, RAM, I/O in a 20-lead package
- 1 kbyte ROM (PCF84C12A)
- 2 kbyte ROM (PCF84C22A)
- 4 kbyte ROM (PCF84C42A)
- 64 byte RAM
- Over 100 instructions (based on MAB8048) all of 1 or 2 cycles
- 13 quasi-bidirectional I/O port lines
- 8-bit programmable timer/event counter 1
- Two single-level vectored interrupts:
 - external
 - 8-bit programmable timer/event counter 1
- Two test inputs, one of which also serves as the external interrupt input
- Stop and Idle modes
- Supply voltage: 2.5 to 5.5 V
- Clock frequency: 1 to 16 MHz
- Operating temperature: –40 to +85 °C.

2 GENERAL DESCRIPTION

This data sheet details the specific properties of the PCF84C12A, PCF84C22A and PCF84C42A. The shared properties of the PCF84CxxxA family of microcontrollers are described in the “PCF84CxxxA family” data sheet, which should be read in conjunction with this publication. Note that the devices described in this data sheet do not feature I²C-bus compatibility or derivative logic, so the information given in the family data sheet about these features can be ignored.

The PCF84C12A, PCF84C22A and PCF84C42A are general purpose CMOS microcontrollers with 1 kbyte, 2 kbytes and 4 kbytes of program memory, respectively. They include 64 bytes of RAM and 13 I/O port lines. The instruction set is based on the MAB8048 and is a sub-set of that listed in the “PCF84CxxxA family” data sheet.

3 ORDERING INFORMATION (see note 1)

TYPE NUMBER	PACKAGE		
	NAME	DESCRIPTION	VERSION
PCF84C12AP	DIP20	plastic dual in-line package; 20 leads (300 mil)	SOT146-1
PCF84C22AP			
PCF84C42AP			
PCF84C12AT	SO20	plastic small outline package; 20 leads; body width 7.5 mm	SOT163-1
PCF84C22AT			
PCF84C42AT			

Note

1. Please refer to the Order Entry Form (OEF) for these devices for the full type number to use when ordering. This type number will also specify the required program and ROM mask options.

8-bit microcontrollers

PCF84C12A; PCF84C22A; PCF84C42A

4 BLOCK DIAGRAM

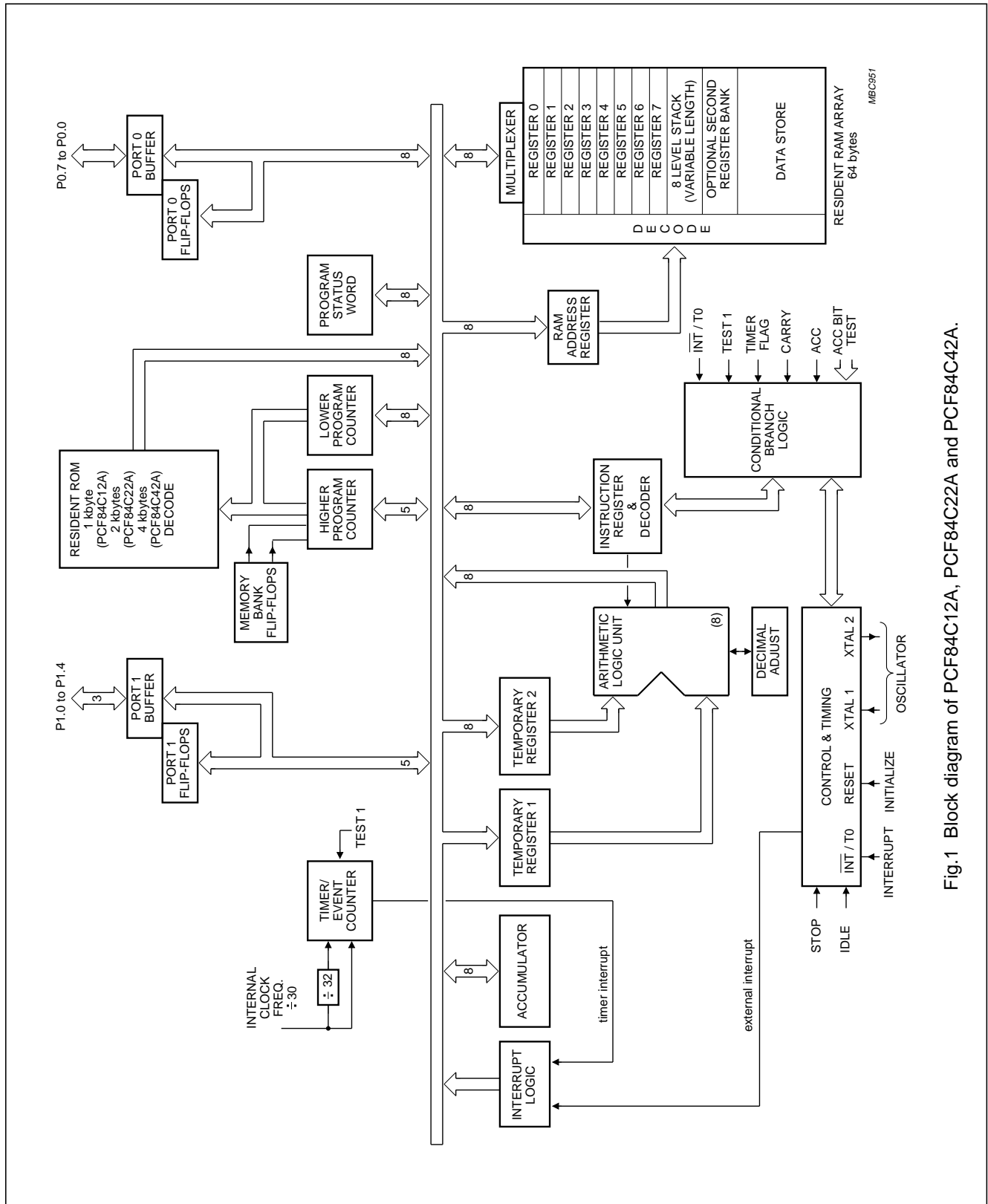

Fig.1 Block diagram of PCF84C12A, PCF84C22A and PCF84C42A.

8-bit microcontrollers

PCF84C12A; PCF84C22A;
PCF84C42A

5 PINNING INFORMATION

5.1 Pinning

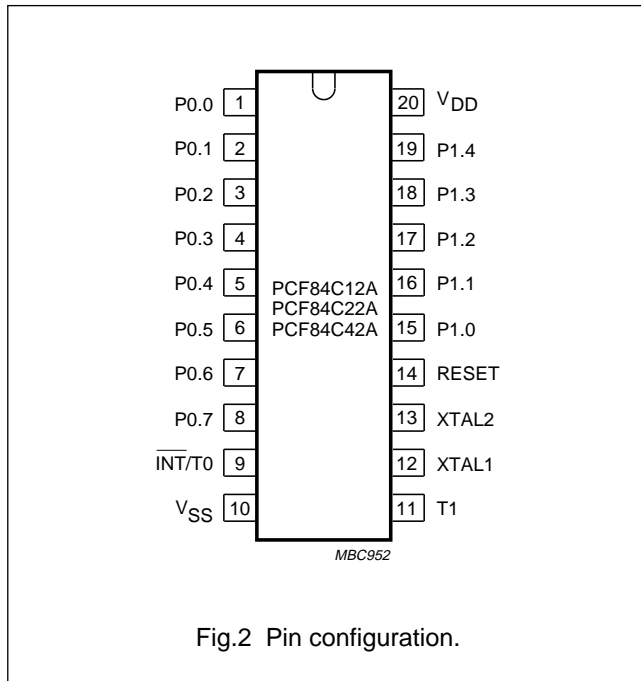

5.2 Pin description

Table 1 DIP20 and SO20 packages

SYMBOL	PIN	TYPE	DESCRIPTION
P0.0 to P0.7	1 to 8	I/O	8 bits of Port 0: 8-bit quasi-bidirectional I/O port
$\overline{\text{INT}}/\text{T0}$	9	I	Interrupt/Test 0
V _{SS}	10	P	ground
T1	11	I	Test 1/count input of 8-bit timer/event counter 1
XTAL1	12	I	crystal oscillator input or external clock input
XTAL2	13	O	crystal oscillator output
RESET	14	I	Reset input
P1.0 to P1.4	15 to 19	I/O	4 bits of Port 1: 4-bit quasi-bidirectional I/O port
V _{DD}	20	P	positive supply

6 INSTRUCTION SET

Since the I²C-bus interface, Port 2 and derivative logic are not provided, instructions associated with these functions are not available.

ROM space is restricted to 1 kbyte for the PCF84C12A, 2 kbytes for the PCF84C22A and 4 kbytes for the PCF84C42A. Therefore, the instructions SEL MB1/2/3 for the PCF84C12A and PCF84C22A, and the instructions SEL MB2/3 for PCF84C42A should be avoided as they would define non-existing program memory banks.

As RAM space is limited to 64 bytes, care should be taken to avoid accesses to non-existing RAM locations.

Refer to the "PCF84CxxxA family" data sheet, for a complete description of the instruction set.

8-bit microcontrollers

PCF84C12A; PCF84C22A;
PCF84C42A

7 ROM MASK OPTIONS

ROM CODE	OPTION		
Program/data	Any mix of instructions and data up to ROM size of 1 kbyte for the PCF84C12A, 2 kbytes for the PCF84C22A and 4 kbytes for the PCF84C42A.		
Port Output			
P0.0 to P0.7	standard	open-drain	push-pull
P1.0 to P1.4	standard	open-drain	push-pull
Port State after reset			
P0.0 to P0.7	set	reset	–
P1.0 to P1.4	set	reset	–
Oscillator			
Transconductance	LOW (g _{mL})	MEDIUM (g _{mM})	HIGH (g _{mH})

8 HANDLING

Inputs and outputs are protected against electrostatic discharge in normal handling. However, it is good practice to take normal precautions appropriate to handling MOS devices. See *"Data Handbook IC14, Section: Handling MOS devices"*.

9 LIMITING VALUES

In accordance with the Absolute Maximum Rating System (IEC 134).

SYMBOL	PARAMETER	MIN.	MAX.	UNIT
V _{DD}	supply voltage	–0.5	+7	V
V _I	all input voltages	–0.5	V _{DD} + 0.5	V
I _I	DC input current	–10	+10	mA
I _O	DC output current except Port 1 output LOW	–10	+10	mA
P _{tot}	total power dissipation	–	125	mW
P _O	power dissipation per output	–	30	mW
I _{DD}	supply current	–50	+50	mA
I _{SS}	ground supply current	–100	+50	mA
T _{stg}	storage temperature range	–55	+150	°C
T _j	operating junction temperature	–	90	°C

8-bit microcontrollers

PCF84C12A; PCF84C22A;
PCF84C42A**10 DC CHARACTERISTICS**

$V_{DD} = 2.5$ to 5.5 V; $V_{SS} = 0$ V; $T_{amb} = -40$ to $+85$ °C; all voltages with respect to V_{SS} ; unless otherwise specified.

SYMBOL	PARAMETER	CONDITIONS	MIN.	TYP.	MAX.	UNIT
V_{DD}	operating supply voltage	see Fig.3	2.5	–	5.5	V
I_{DD}	operating supply current	note 1; see Figs 4 and 5 $V_{DD} = 3$ V; $f_{xtal} = 3.58$ MHz (g_{mL}) $V_{DD} = 5$ V; $f_{xtal} = 10$ MHz (g_{mL}) $V_{DD} = 5$ V; $f_{xtal} = 16$ MHz (g_{mM}) $V_{DD} = 5$ V; $f_{xtal} = 16$ MHz (g_{mH})	– – – –	0.3 1.1 1.7 2.5	0.6 3.0 5.0 6.0	mA mA mA mA
$I_{DD(idle)}$	supply current (Idle mode)	note 1; see Figs 6 and 7 $V_{DD} = 3$ V; $f_{xtal} = 3.58$ MHz (g_{mL}) $V_{DD} = 5$ V; $f_{xtal} = 10$ MHz (g_{mL}) $V_{DD} = 5$ V; $f_{xtal} = 16$ MHz (g_{mM}) $V_{DD} = 5$ V; $f_{xtal} = 16$ MHz (g_{mH})	– – – –	0.2 0.8 1.2 1.7	0.4 1.6 4.0 5.0	mA mA mA mA
$I_{DD(stp)}$	supply current (Stop mode)	$V_{DD} = 2.5$ V; notes 1 and 2; see Fig.8	–	1.2	10	µA
Inputs						
V_{IL}	LOW level input voltage		0	–	$0.3V_{DD}$	V
V_{IH}	HIGH level input voltage		$0.7V_{DD}$	–	V_{DD}	V
I_{LI}	input leakage	$V_{SS} \leq V_I \leq V_{DD}$	–1	–	+1	µA
Outputs						
I_{OL}	LOW level output sink current	$V_{DD} = 5$ V; $V_O = 0.4$ V; see Fig.9	1.6	12	–	mA
I_{OH}	HIGH level pull-up output source current	$V_{DD} = 5$ V; $V_O = 3.5$ V; see Fig.10	40	100	–	µA
		$V_{DD} = 5$ V; $V_O = 0$ V; see Fig.10	–	–140	–400	µA
I_{OH1}	HIGH level push-pull output source current	$V_{DD} = 5$ V; $V_O = 4.6$ V; see Fig.11	–1.6	–7	–	mA
Oscillator (see Fig.12)						
g_{mL}	LOW transconductance	$V_{DD} = 5$ V	0.2	0.4	1.0	mS
g_{mM}	MEDIUM transconductance	$V_{DD} = 5$ V	0.9	1.6	3.2	mS
g_{mH}	HIGH transconductance	$V_{DD} = 5$ V	3.0	4.5	9.0	mS
R_F	feedback resistor		0.3	1.0	3.0	MΩ

Notes

- $V_{IL} = V_{SS}$; $V_{IH} = V_{DD}$; open drain outputs connected to V_{SS} ; all other outputs, including XTAL2, open (typical values at 25 °C with crystal connected between XTAL1 and XTAL2).
- $V_{IL} = V_{SS}$; $V_{IH} = V_{DD}$; RESET and T1 at V_{SS} ; $\overline{INT}/T0$ at V_{DD} ; crystal connected between XTAL1 and XTAL2; open drain outputs connected to V_{SS} ; all other outputs open.

8-bit microcontrollers

PCF84C12A; PCF84C22A;
PCF84C42A

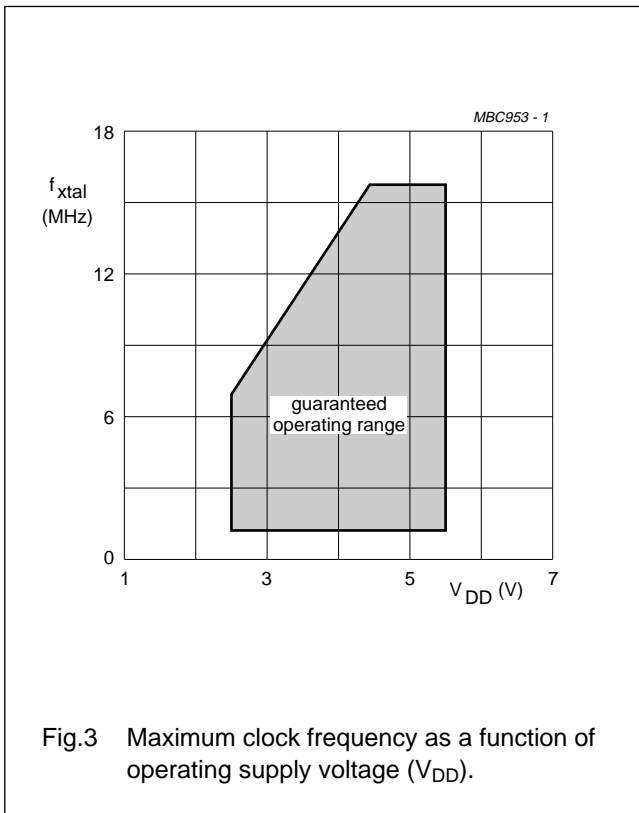
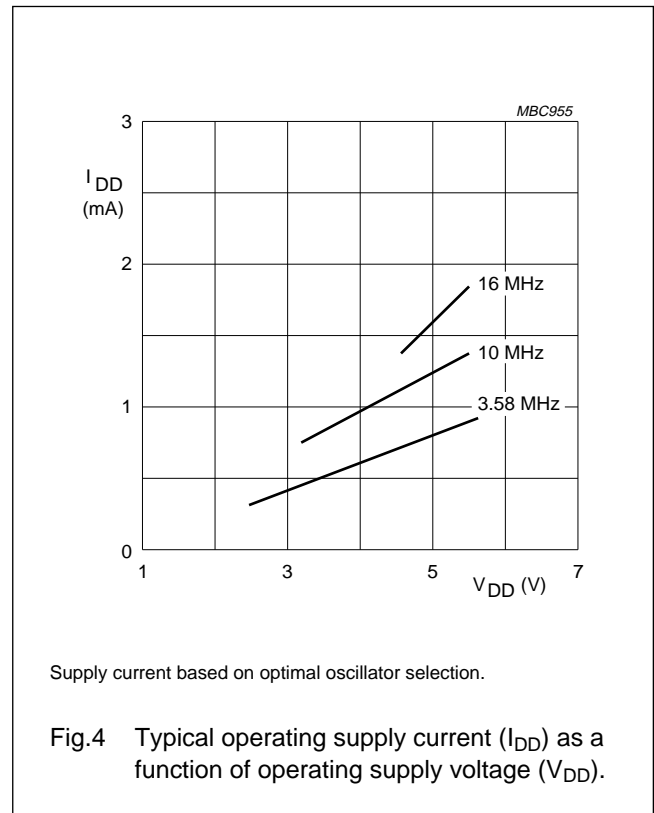
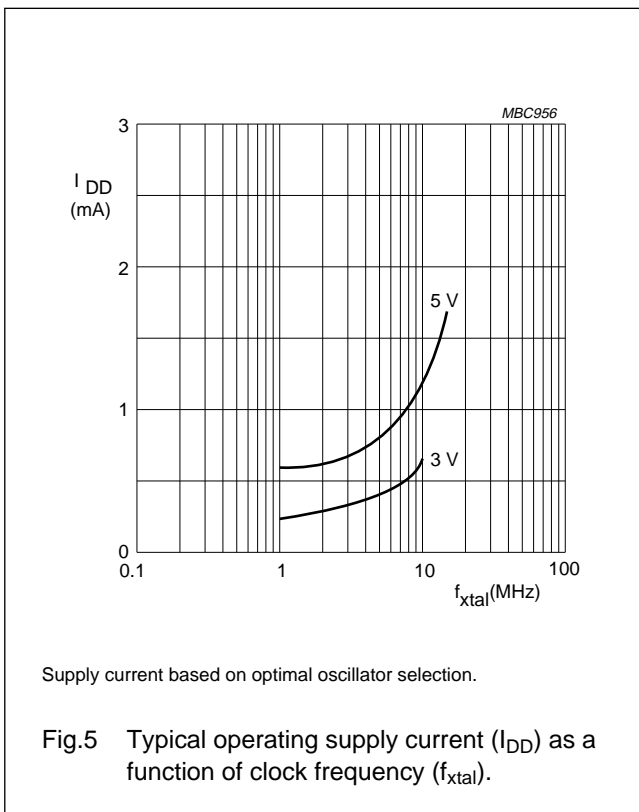

Fig.3 Maximum clock frequency as a function of operating supply voltage (V_{DD}).



Supply current based on optimal oscillator selection.

Fig.4 Typical operating supply current (I_{DD}) as a function of operating supply voltage (V_{DD}).



Supply current based on optimal oscillator selection.

Fig.5 Typical operating supply current (I_{DD}) as a function of clock frequency (f_{xtal}).

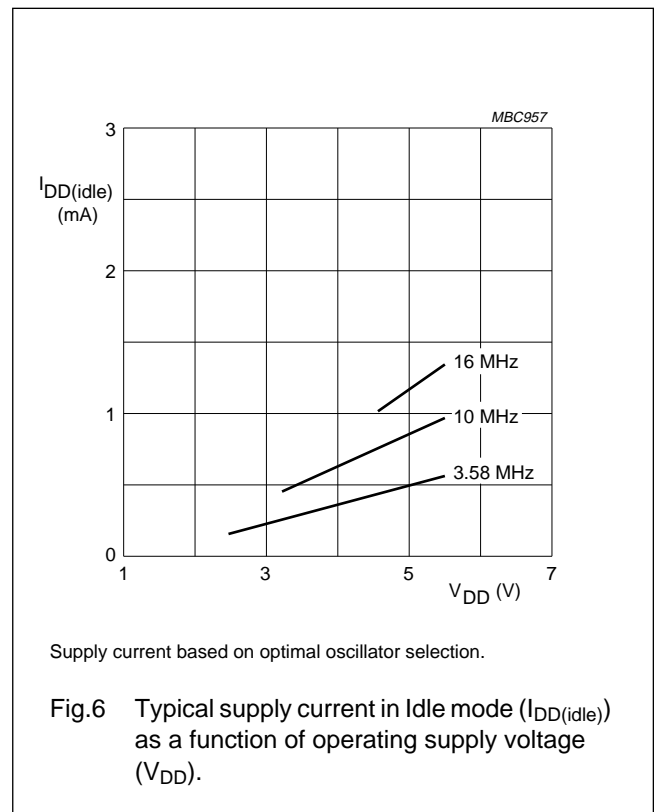

Supply current based on optimal oscillator selection.

Fig.6 Typical supply current in Idle mode ($I_{DD(idle)}$) as a function of operating supply voltage (V_{DD}).

8-bit microcontrollers

PCF84C12A; PCF84C22A;
PCF84C42A

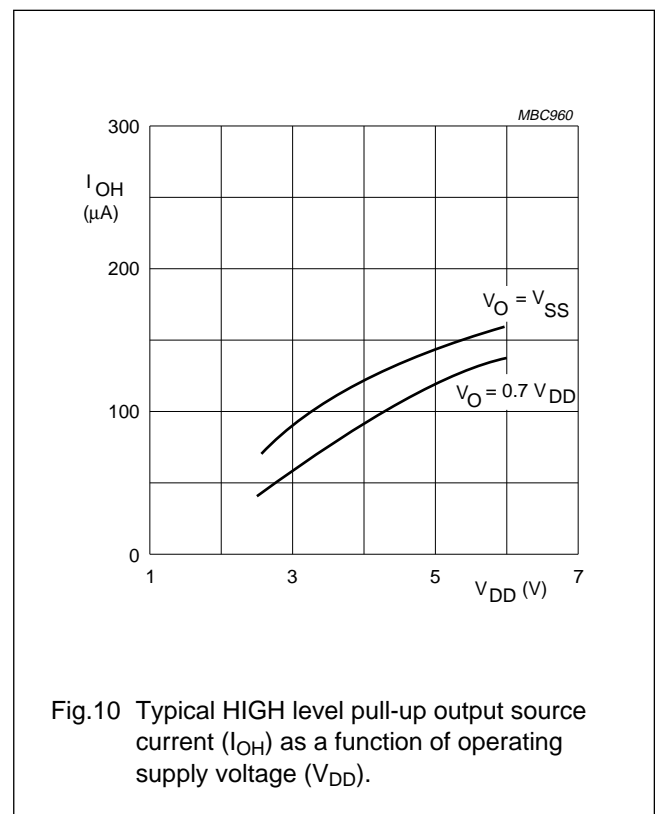
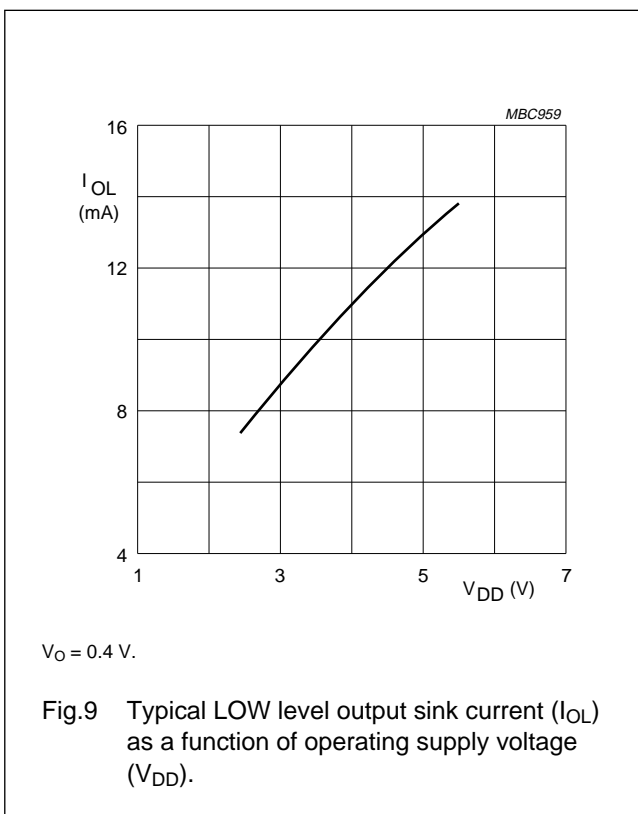
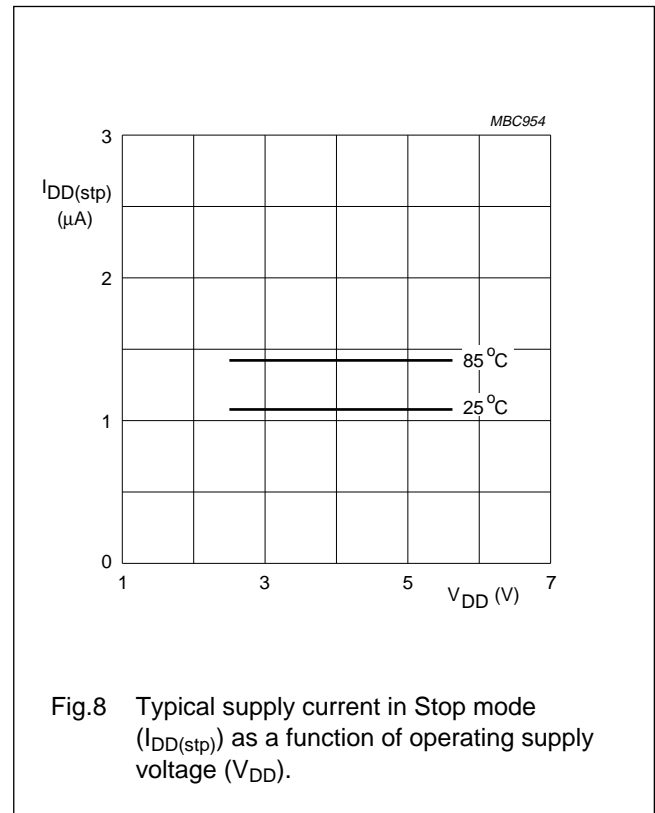
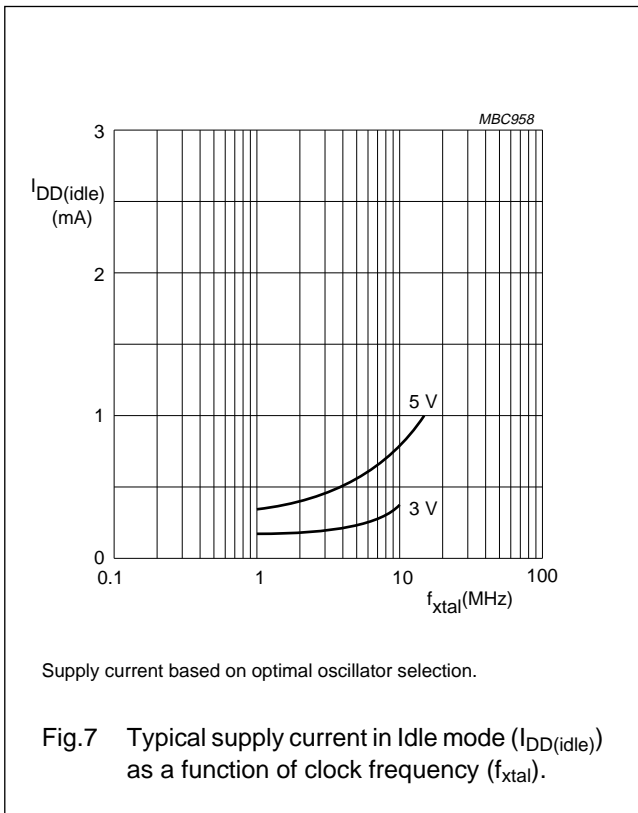

8-bit microcontrollers

PCF84C12A; PCF84C22A;
PCF84C42A

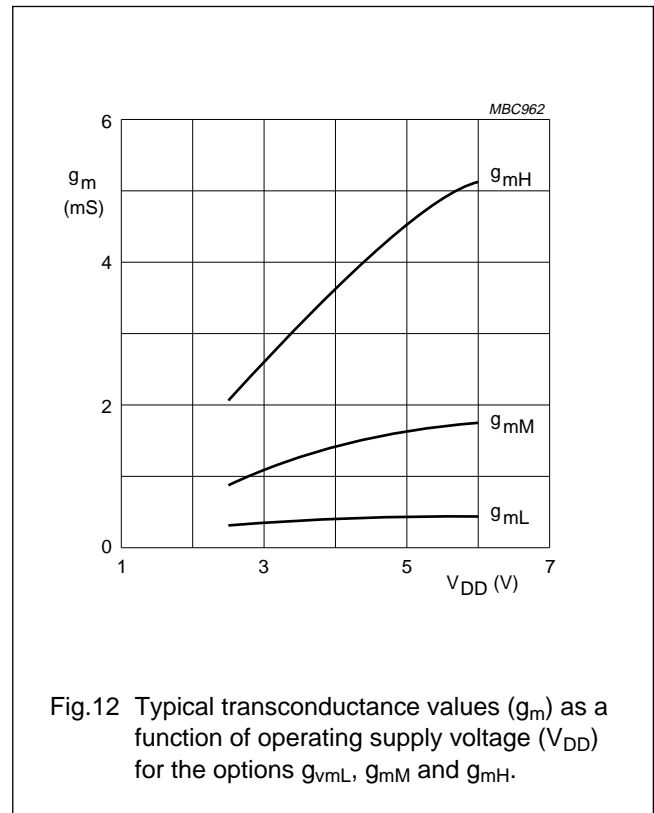
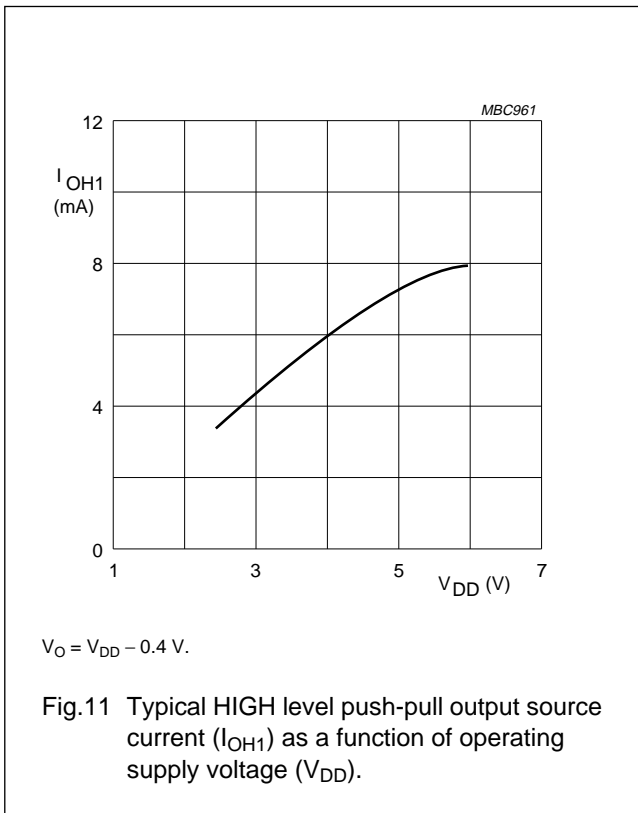

11 AC CHARACTERISTICS

$V_{DD} = 2.5$ to 5.5 V; $V_{SS} = 0$ V; $T_{amb} = -40$ to $+85$ °C; all voltages with respect to V_{SS} ; unless otherwise specified.

SYMBOL	PARAMETER	CONDITIONS	MIN.	TYP.	MAX.	UNIT
t_r	rise time all outputs	$V_{DD} = 5$ V; $T_{amb} = 25$ °C; $C_L = 50$ pF	–	30	–	ns
t_f	fall time all outputs	$V_{DD} = 5$ V; $T_{amb} = 25$ °C; $C_L = 50$ pF	–	30	–	ns
f_{xtal}	clock frequency	see Fig.3	1	–	16	MHz

8-bit microcontrollers

PCF84C12A; PCF84C22A;
PCF84C42A

12 PACKAGE OUTLINES

DIP20: plastic dual in-line package; 20 leads (300 mil)

SOT146-1

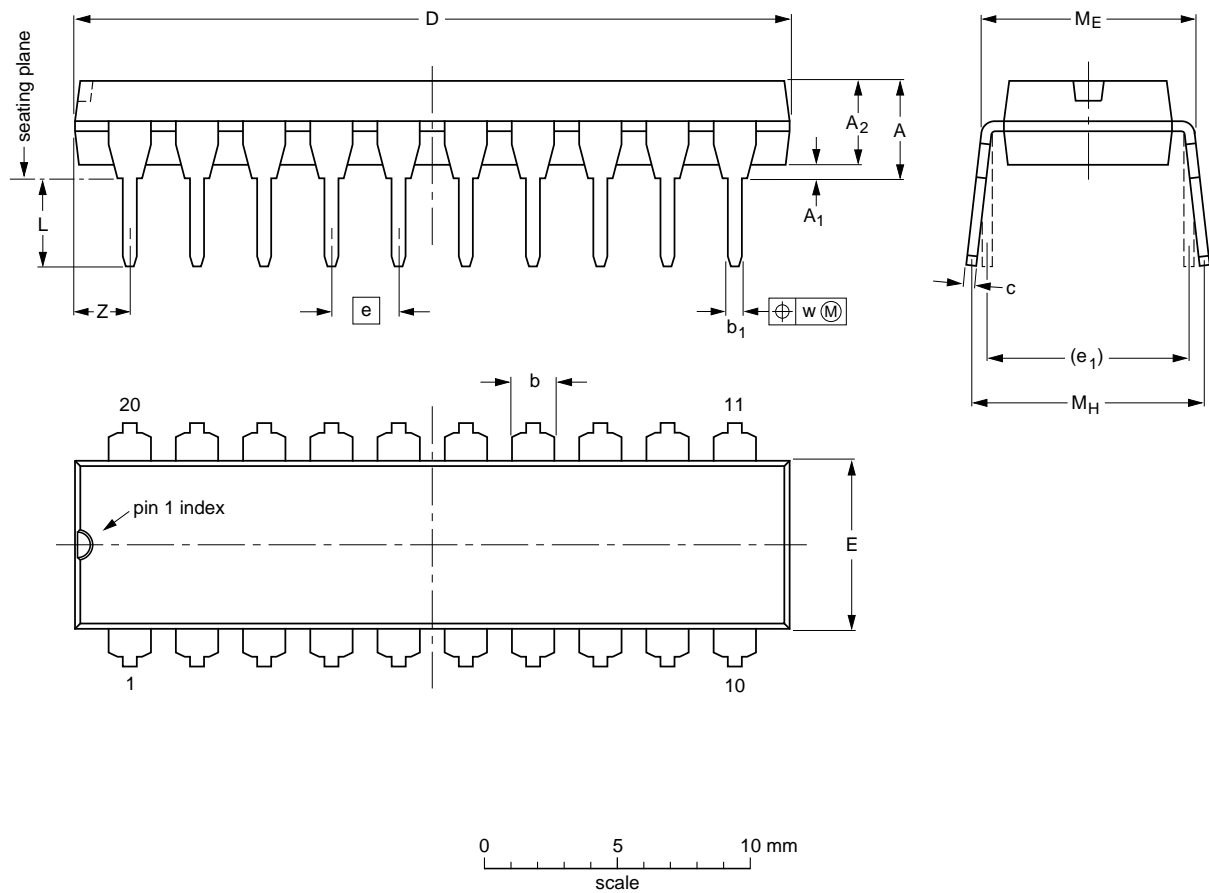

DIMENSIONS (inch dimensions are derived from the original mm dimensions)

UNIT	A max.	A ₁ min.	A ₂ max.	b	b ₁	c	D ⁽¹⁾	E ⁽¹⁾	e	e ₁	L	M _E	M _H	w	Z ⁽¹⁾ max.
mm	4.2	0.51	3.2	1.73 1.30	0.53 0.38	0.36 0.23	26.92 26.54	6.40 6.22	2.54	7.62	3.60 3.05	8.25 7.80	10.0 8.3	0.254	2.0
inches	0.17	0.020	0.13	0.068 0.051	0.021 0.015	0.014 0.009	1.060 1.045	0.25 0.24	0.10	0.30	0.14 0.12	0.32 0.31	0.39 0.33	0.01	0.078

Note

1. Plastic or metal protrusions of 0.25 mm maximum per side are not included.

OUTLINE VERSION	REFERENCES			EUROPEAN PROJECTION	ISSUE DATE
	IEC	JEDEC	EIAJ		
SOT146-1			SC603		92-11-17 95-05-24

8-bit microcontrollers

PCF84C12A; PCF84C22A;
PCF84C42A

SO20: plastic small outline package; 20 leads; body width 7.5 mm

SOT163-1

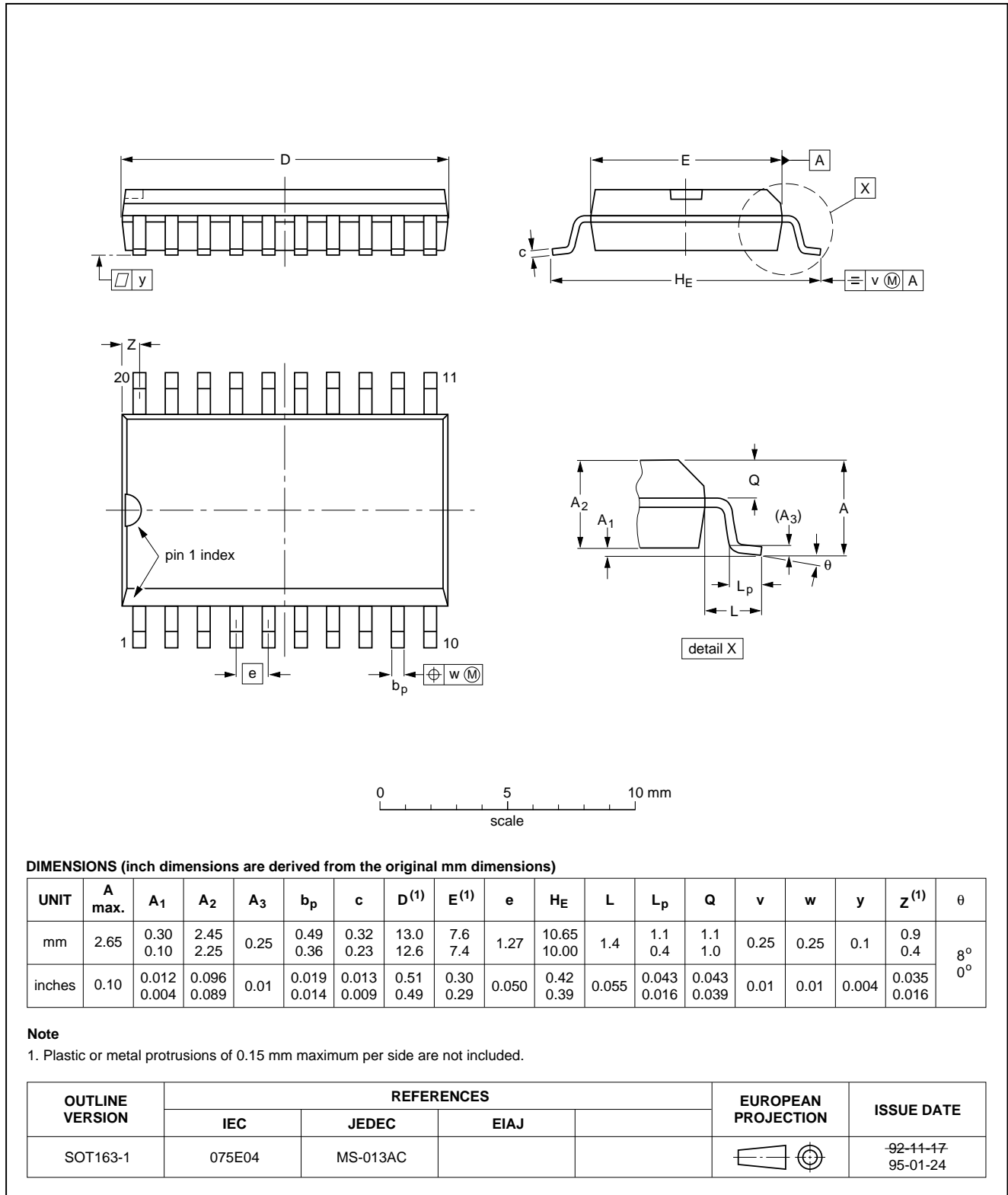

8-bit microcontrollers

PCF84C12A; PCF84C22A; PCF84C42A

13 SOLDERING

13.1 Introduction

There is no soldering method that is ideal for all IC packages. Wave soldering is often preferred when through-hole and surface mounted components are mixed on one printed-circuit board. However, wave soldering is not always suitable for surface mounted ICs, or for printed-circuits with high population densities. In these situations reflow soldering is often used.

This text gives a very brief insight to a complex technology. A more in-depth account of soldering ICs can be found in our "IC Package Databook" (order code 9398 652 90011).

13.2 DIP

13.2.1 SOLDERING BY DIPPING OR BY WAVE

The maximum permissible temperature of the solder is 260 °C; solder at this temperature must not be in contact with the joint for more than 5 seconds. The total contact time of successive solder waves must not exceed 5 seconds.

The device may be mounted up to the seating plane, but the temperature of the plastic body must not exceed the specified maximum storage temperature ($T_{stg\ max}$). If the printed-circuit board has been pre-heated, forced cooling may be necessary immediately after soldering to keep the temperature within the permissible limit.

13.2.2 REPAIRING SOLDERED JOINTS

Apply a low voltage soldering iron (less than 24 V) to the lead(s) of the package, below the seating plane or not more than 2 mm above it. If the temperature of the soldering iron bit is less than 300 °C it may remain in contact for up to 10 seconds. If the bit temperature is between 300 and 400 °C, contact may be up to 5 seconds.

13.3 SO

13.3.1 REFLOW SOLDERING

Reflow soldering techniques are suitable for all SO packages.

Reflow soldering requires solder paste (a suspension of fine solder particles, flux and binding agent) to be applied to the printed-circuit board by screen printing, stencilling or pressure-syringe dispensing before package placement.

Several techniques exist for reflowing; for example, thermal conduction by heated belt. Dwell times vary between 50 and 300 seconds depending on heating method. Typical reflow temperatures range from 215 to 250 °C.

Preheating is necessary to dry the paste and evaporate the binding agent. Preheating duration: 45 minutes at 45 °C.

13.3.2 WAVE SOLDERING

Wave soldering techniques can be used for all SO packages if the following conditions are observed:

- A double-wave (a turbulent wave with high upward pressure followed by a smooth laminar wave) soldering technique should be used.
- The longitudinal axis of the package footprint must be parallel to the solder flow.
- The package footprint must incorporate solder thieves at the downstream end.

During placement and before soldering, the package must be fixed with a droplet of adhesive. The adhesive can be applied by screen printing, pin transfer or syringe dispensing. The package can be soldered after the adhesive is cured.

Maximum permissible solder temperature is 260 °C, and maximum duration of package immersion in solder is 10 seconds, if cooled to less than 150 °C within 6 seconds. Typical dwell time is 4 seconds at 250 °C.

A mildly-activated flux will eliminate the need for removal of corrosive residues in most applications.

13.3.3 REPAIRING SOLDERED JOINTS

Fix the component by first soldering two diagonally-opposite end leads. Use only a low voltage soldering iron (less than 24 V) applied to the flat part of the lead. Contact time must be limited to 10 seconds at up to 300 °C. When using a dedicated tool, all other leads can be soldered in one operation within 2 to 5 seconds between 270 and 320 °C.

8-bit microcontrollers

PCF84C12A; PCF84C22A;
PCF84C42A**14 DEFINITIONS**

Data sheet status	
Objective specification	This data sheet contains target or goal specifications for product development.
Preliminary specification	This data sheet contains preliminary data; supplementary data may be published later.
Product specification	This data sheet contains final product specifications.
Limiting values	
Limiting values given are in accordance with the Absolute Maximum Rating System (IEC 134). Stress above one or more of the limiting values may cause permanent damage to the device. These are stress ratings only and operation of the device at these or at any other conditions above those given in the Characteristics sections of the specification is not implied. Exposure to limiting values for extended periods may affect device reliability.	
Application information	
Where application information is given, it is advisory and does not form part of the specification.	

15 LIFE SUPPORT APPLICATIONS

These products are not designed for use in life support appliances, devices, or systems where malfunction of these products can reasonably be expected to result in personal injury. Philips customers using or selling these products for use in such applications do so at their own risk and agree to fully indemnify Philips for any damages resulting from such improper use or sale.

8-bit microcontrollers

PCF84C12A; PCF84C22A;
PCF84C42A

NOTES

Philips Semiconductors – a worldwide company

Argentina: see South America

Australia: 34 Waterloo Road, NORTH RYDE, NSW 2113,
Tel. +61 2 9805 4455, Fax. +61 2 9805 4466

Austria: Computerstr. 6, A-1101 WIEN, P.O. Box 213,
Tel. +43 1 60 101, Fax. +43 1 60 101 1210

Belarus: Hotel Minsk Business Center, Bld. 3, r. 1211, Volodarski Str. 6,
220050 MINSK, Tel. +375 172 200 733, Fax. +375 172 200 773

Belgium: see The Netherlands

Brazil: see South America

Bulgaria: Philips Bulgaria Ltd., Energoproject, 15th floor,
51 James Bourchier Blvd., 1407 SOFIA,
Tel. +359 2 689 211, Fax. +359 2 689 102

Canada: PHILIPS SEMICONDUCTORS/COMPONENTS,
Tel. +1 800 234 7381

China/Hong Kong: 501 Hong Kong Industrial Technology Centre,
72 Tat Chee Avenue, Kowloon Tong, HONG KONG,
Tel. +852 2319 7888, Fax. +852 2319 7700

Colombia: see South America

Czech Republic: see Austria

Denmark: Prags Boulevard 80, PB 1919, DK-2300 COPENHAGEN S,
Tel. +45 32 88 2636, Fax. +45 31 57 1949

Finland: Sinikalliontie 3, FIN-02630 ESPOO,
Tel. +358 9 615800, Fax. +358 9 61580/xxx

France: 4 Rue du Port-aux-Vins, BP317, 92156 SURESNES Cedex,
Tel. +33 1 40 99 6161, Fax. +33 1 40 99 6427

Germany: Hammerbrookstraße 69, D-20097 HAMBURG,
Tel. +49 40 23 53 60, Fax. +49 40 23 536 300

Greece: No. 15, 25th March Street, GR 17778 TAVROS/ATHENS,
Tel. +30 1 4894 339/239, Fax. +30 1 4814 240

Hungary: see Austria

India: Philips INDIA Ltd, Shivsagar Estate, A Block, Dr. Annie Besant Rd.
Worli, MUMBAI 400 018, Tel. +91 22 4938 541, Fax. +91 22 4938 722

Indonesia: see Singapore

Ireland: Newstead, Clonskeagh, DUBLIN 14,
Tel. +353 1 7640 000, Fax. +353 1 7640 200

Israel: RAPAC Electronics, 7 Kehilat Saloniki St, TEL AVIV 61180,
Tel. +972 3 645 0444, Fax. +972 3 649 1007

Italy: PHILIPS SEMICONDUCTORS, Piazza IV Novembre 3,
20124 MILANO, Tel. +39 2 6752 2531, Fax. +39 2 6752 2557

Japan: Philips Bldg 13-37, Kohnan 2-chome, Minato-ku, TOKYO 108,
Tel. +81 3 3740 5130, Fax. +81 3 3740 5077

Korea: Philips House, 260-199 Itaewon-dong, Yongsan-ku, SEOUL,
Tel. +82 2 709 1412, Fax. +82 2 709 1415

Malaysia: No. 76 Jalan Universiti, 46200 PETALING JAYA, SELANGOR,
Tel. +60 3 750 5214, Fax. +60 3 757 4880

Mexico: 5900 Gateway East, Suite 200, EL PASO, TEXAS 79905,
Tel. +9-5 800 234 7381

Middle East: see Italy

Netherlands: Postbus 90050, 5600 PB EINDHOVEN, Bldg. VB,
Tel. +31 40 27 82785, Fax. +31 40 27 88399

New Zealand: 2 Wagener Place, C.P.O. Box 1041, AUCKLAND,
Tel. +64 9 849 4160, Fax. +64 9 849 7811

Norway: Box 1, Manglerud 0612, OSLO,
Tel. +47 22 74 8000, Fax. +47 22 74 8341

Philippines: Philips Semiconductors Philippines Inc.,
106 Valero St. Salcedo Village, P.O. Box 2108 MCC, MAKATI,
Metro MANILA, Tel. +63 2 816 6380, Fax. +63 2 817 3474

Poland: Ul. Lukiska 10, PL 04-123 WARSZAWA,
Tel. +48 22 612 2831, Fax. +48 22 612 2327

Portugal: see Spain

Romania: see Italy

Russia: Philips Russia, Ul. Usatcheva 35A, 119048 MOSCOW,
Tel. +7 095 247 9145, Fax. +7 095 247 9144

Singapore: Lorong 1, Toa Payoh, SINGAPORE 1231,
Tel. +65 350 2538, Fax. +65 251 6500

Slovakia: see Austria

Slovenia: see Italy

South Africa: S.A. PHILIPS Pty Ltd., 195-215 Main Road Martindale,
2092 JOHANNESBURG, P.O. Box 7430 Johannesburg 2000,
Tel. +27 11 470 5911, Fax. +27 11 470 5494

South America: Rua do Rocio 220, 5th floor, Suite 51,
04552-903 São Paulo, SÃO PAULO - SP, Brazil,
Tel. +55 11 821 2333, Fax. +55 11 829 1849

Spain: Balmes 22, 08007 BARCELONA,
Tel. +34 3 301 6312, Fax. +34 3 301 4107

Sweden: Kottbygatan 7, Akalla, S-16485 STOCKHOLM,
Tel. +46 8 632 2000, Fax. +46 8 632 2745

Switzerland: Allmendstrasse 140, CH-8027 ZÜRICH,
Tel. +41 1 488 2686, Fax. +41 1 481 7730

Taiwan: PHILIPS TAIWAN Ltd., 23-30F, 66,
Chung Hsiao West Road, Sec. 1, P.O. Box 22978,
TAIPEI 100, Tel. +886 2 382 4443, Fax. +886 2 382 4444

Thailand: PHILIPS ELECTRONICS (THAILAND) Ltd.,
209/2 Sanpavuth-Bangna Road Prakanong, BANGKOK 10260,
Tel. +66 2 745 4090, Fax. +66 2 398 0793

Turkey: Talatpasa Cad. No. 5, 80640 GÜLTEPE/ISTANBUL,
Tel. +90 212 279 2770, Fax. +90 212 282 6707

Ukraine: PHILIPS UKRAINE, 4 Patrice Lumumba str., Building B, Floor 7,
252042 KIEV, Tel. +380 44 264 2776, Fax. +380 44 268 0461

United Kingdom: Philips Semiconductors Ltd., 276 Bath Road, Hayes,
MIDDLESEX UB3 5BX, Tel. +44 181 730 5000, Fax. +44 181 754 8421

United States: 811 East Arques Avenue, SUNNYVALE, CA 94088-3409,
Tel. +1 800 234 7381

Uruguay: see South America

Vietnam: see Singapore

Yugoslavia: PHILIPS, Trg N. Pasica 5/v, 11000 BEOGRAD,
Tel. +381 11 625 344, Fax. +381 11 635 777

For all other countries apply to: Philips Semiconductors, Marketing & Sales Communications,
Building BE-p, P.O. Box 218, 5600 MD EINDHOVEN, The Netherlands, Fax. +31 40 27 24825

Internet: <http://www.semiconductors.philips.com>

© Philips Electronics N.V. 1996

SCA52

All rights are reserved. Reproduction in whole or in part is prohibited without the prior written consent of the copyright owner.

The information presented in this document does not form part of any quotation or contract, is believed to be accurate and reliable and may be changed without notice. No liability will be accepted by the publisher for any consequence of its use. Publication thereof does not convey nor imply any license under patent- or other industrial or intellectual property rights.

Printed in The Netherlands

457021/1200/04/pp16

Date of release: 1996 Nov 20

Document order number: 9397 750 01086

Let's make things better.

Philips
Semiconductors



PHILIPS
www.DataSheet4U.com