

RN5RZ SERIES

OUTLINE

The RN5RZ Series are voltage regulator ICs with high output voltage accuracy, low supply current, low dropout voltage and high ripple rejection developed through the use of a CMOS process. Each of these voltage regulator ICs consists of a voltage reference unit, an error amplifier, output voltage setting resistors, a current limit circuit and a chip enable circuit. (Provided two types of chip enable circuit ; "H" active and "L" active, that can be selected when order.)

The output voltage of these ICs is fixed with high accuracy.

In addition to low supply current from CMOS process, the RN5RZ Series may lengthen battery life through low dropout voltage and chip enable function thanks to the built-in low ON resistance transistor. Also when compared with conventional regulators that employ CMOS process, these ICs have superior ripple rejection, input transient response characteristic and load transient response characteristic thus making these product suitable for power supply for hand-held communication equipment.

Since the package for these ICs is the SOT-23-5 package, high density mounting of the ICs on boards is possible.

FEATURES

- Ultra-Low Supply Current.....TYP. 20 μ A
- Ultra-Low Supply Current (Standby).....TYP. 0.1 μ A
- High Accuracy Output Voltage..... \pm 2.0%
- High Ripple Rejection.....TYP.55dB (f=1kHz)
- Low Dropout Voltage.....TYP. 0.2V (I_{OUT}=60mA)
- Low Temperature-Drift Coefficient of Output Voltage.....TYP. \pm 100ppm/ $^{\circ}$ C
- Excellent Line Regulation.....TYP. 0.05%/V
- Output Voltage.....Stepwise setting with a step of 0.1V in the range of 2.0V to 6.0V is possible (refer to Selection Guide).
- Built-in Short Current Limit Circuit.....TYP. 50mA
- Small Package.....SOT-23-5 (Mini-mold)

APPLICATIONS

- Power source for battery-powered equipment.
- Power source for cellular phones, cameras, VCRs, camcorders, hand-held audio instruments and hand-held communication equipment.
- Power source for domestic appliances.

7744690 0004003 073

BLOCK DIAGRAMS

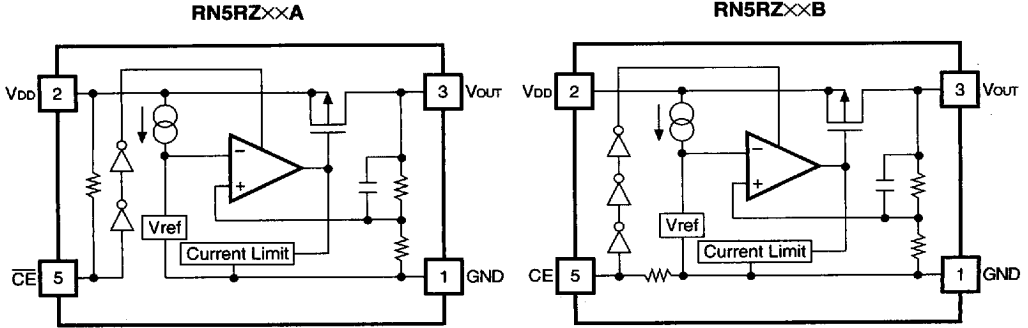

SELECTION GUIDE

The output voltage, the active type of the chip enable circuit, the packing type, and the taping type for the ICs can be selected at the user's request.

These selections can be made by designating the part number as shown below:

RN5RZ xxxx - xx ← Part Number
 ↑ ↑ ↑ ↑
 a b c d

Code	Contents
a	Setting Output Voltage (Vout) : Stepwise setting with a step of 0.1V in the range of 2.0V to 6.0V is possible.
b	Designation of Active Type of The Chip Enable Circuit : A : "L" active type B : "H" active type
c	Designation of Packing Type : A : Taping C : Antistatic bag (for Samples only)
d	Designation of Taping Type : Ex. TR, TL (refer to Taping Specifications ; TR type is the standard direction.)

For example, the product with Output Voltage of 5.0V, Specified Polarity of Chip Enable is "H" active and Taping Type TR is designated by Part Number RN5RZ50BA-TR.

7744690 0004004 TOT

RICOH

PIN CONFIGURATION

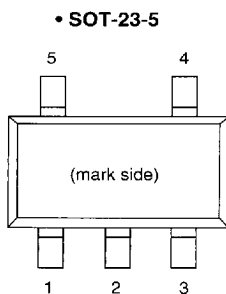

PIN DESCRIPTION

Pin No.	Symbol	Description
1	GND	Ground Pin
2	V _{DD}	Input Pin
3	V _{OUT}	Output Pin
4	NC	No Connection
5	CE or $\overline{\text{CE}}$	Chip Enable Pin

ABSOLUTE MAXIMUM RATINGS

Symbol	Item	Ratings	Unit
V _{IN}	Input Voltage	9	V
V _{CE}	Input Voltage (CE or $\overline{\text{CE}}$ Pin)	-0.3 to V _{IN} +0.3	V
V _{OUT}	Output Voltage	-0.3 to V _{IN} +0.3	V
I _{OUT}	Output Current	200	mA
P _D	Power Dissipation	250	mW
T _{opt}	Operating Temperature	-40 to +85	°C
T _{stg}	Storage Temperature	-55 to +125	°C

ABSOLUTE MAXIMUM RATINGS

Absolute Maximum ratings are threshold limit values that must not be exceeded even for an instant under any conditions. Moreover, such values for any two items must not be reached simultaneously. Operation above these absolute maximum ratings may cause degradation or permanent damage to the device. These are stress ratings only and do not necessarily imply functional operation below these limits.

7744690 0004005 946

RICOH

ELECTRICAL CHARACTERISTICS

• RN5RZ××A Series

T_{opt}=25°C

Symbol	Item	Conditions	MIN.	TYP.	MAX.	Unit
V _{OUT}	Output Voltage	V _{IN} =V _{OUT} +1V, I _{OUT} =30mA	×0.98		×1.02	V
I _{OUT}	Output Current	V _{IN} =V _{OUT} +1V When V _{OUT} =V _{OUT} -0.1V	100			mA
$\frac{\Delta V_{OUT}}{\Delta I_{OUT}}$	Load Regulation	V _{IN} =V _{OUT} +1V 1mA≤I _{OUT} ≤80mA		20	40	mV
V _{DIF}	Dropout Voltage	I _{OUT} =60mA		0.2	0.3	V
I _{SS}	Supply Current	V _{IN} =V _{OUT} +1V		20	40	μA
I _{standby}	Supply Current (Standby)	V _{IN} =V _{CE} =V _{OUT} +1V		0.1	1.0	μA
$\frac{\Delta V_{OUT}}{\Delta V_{IN}}$	Line Regulation	I _{OUT} =30mA V _{OUT} +0.5V≤V _{IN} ≤8V		0.05	0.20	%/V
RR	Ripple Rejection	f=1kHz, Ripple 0.5V _{rms} V _{IN} =V _{OUT} +1V		55		dB
V _{IN}	Input Voltage				8	V
$\frac{\Delta V_{OUT}}{\Delta T_{opt}}$	Output Voltage Temperature Coefficient	I _{OUT} =30mA -40°C≤T _{opt} ≤85°C		±100		ppm/°C
I _{lim}	Short Current Limit	V _{OUT} =0V		50		mA
R _{PU}	\overline{CE} Pull-up Resistance		2.5	5	10	MΩ
V _{CEH}	\overline{CE} Input Voltage "H"		1.5			V
V _{CEL}	\overline{CE} Input Voltage "L"		0		0.25	V

7744690 0004006 882



• RN5RZ××B Series

T_{opt}=25°C

Symbol	Item	Conditions	MIN.	TYP.	MAX.	Unit
V _{OUT}	Output Voltage	V _{IN} =V _{OUT} +1V, I _{OUT} =30mA	×0.98		×1.02	V
I _{OUT}	Output Current	V _{IN} =V _{OUT} +1V When V _{OUT} =V _{OUT} -0.1V	100			mA
$\frac{\Delta V_{OUT}}{\Delta I_{OUT}}$	Load Regulation	V _{IN} =V _{OUT} +1V 1mA≤I _{OUT} ≤80mA		20	40	mV
V _{DIF}	Dropout Voltage	I _{OUT} =60mA		0.2	0.3	V
I _{SS}	Supply Current	V _{IN} =V _{OUT} +1V		20	40	μA
I _{standby}	Supply Current (Standby)	V _{IN} =V _{OUT} +1V, V _{CE} =GND		0.1	1.0	μA
$\frac{\Delta V_{OUT}}{\Delta V_{IN}}$	Line Regulation	I _{OUT} =30mA V _{OUT} +0.5V≤V _{IN} ≤8V		0.05	0.20	%/V
RR	Ripple Rejection	f=1kHz, Ripple 0.5V _{rms} V _{IN} =V _{OUT} +1V		55		dB
V _{IN}	Input Voltage				8	V
$\frac{\Delta V_{OUT}}{\Delta T_{opt}}$	Output Voltage Temperature Coefficient	I _{OUT} =30mA -40°C≤T _{opt} ≤85°C		±100		ppm/°C
I _{lim}	Short Current Limit	V _{OUT} =0V		50		mA
R _{PU}	CE Pull-down Resistance		2.5	5	10	MΩ
V _{CEH}	CE Input Voltage "H"		1.5			V
V _{CEL}	CE Input Voltage "L"		0		0.25	V

7744690 0004007 719

RICOH

OPERATION

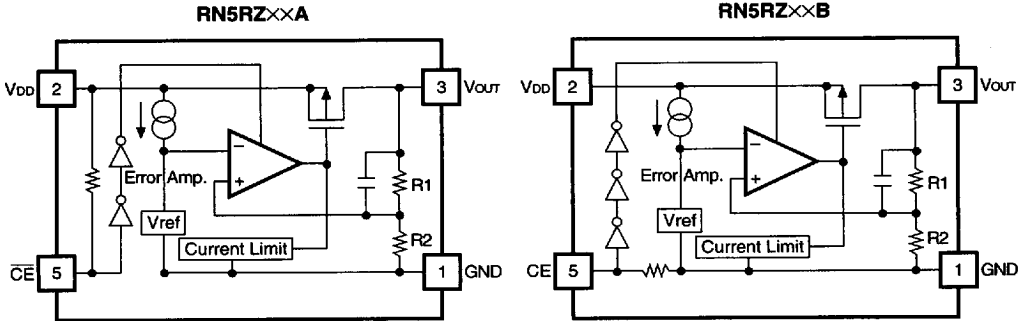

In these ICs, Output Voltage V_{OUT} is detected by Feed-back Registers R1, R2, and the detected Output Voltage is compared with a reference voltage by an Error Amplifier, so that a constant voltage is output.

A current limit circuit working for Short Protect and a chip enable circuit for standby function are included.

TEST CIRCUITS

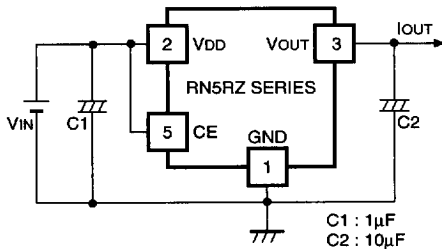

Fig.1 Standard Test Circuit

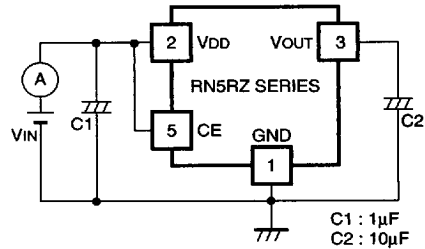

Fig.2 Supply Current Test Circuit

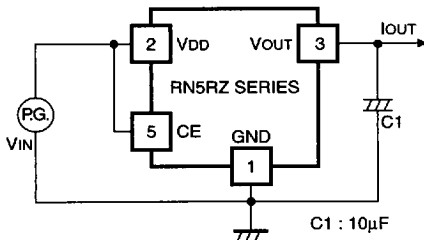

Fig.3 Line Transient Response Test Circuit

7744690 0004008 655

RICOH

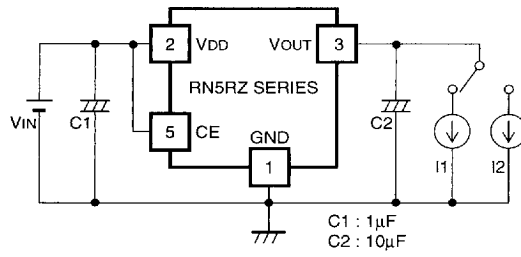

Fig.4 Load Transient Response Test Circuit

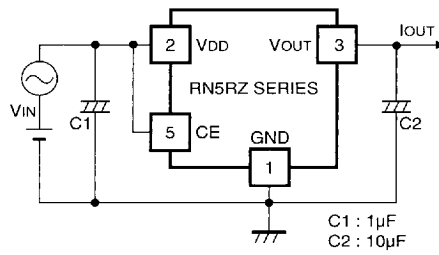

Fig.5 Ripple Rejection Test Circuit

7744690 0004009 591

RICOH

TYPICAL CHARACTERISTICS

1) Output Voltage vs. Output Current

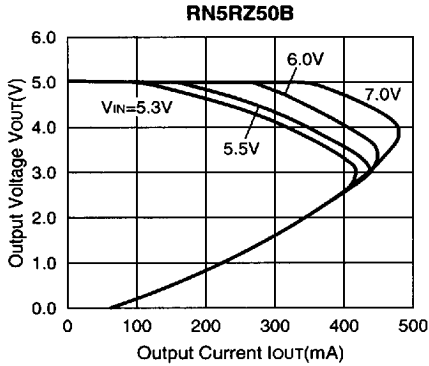
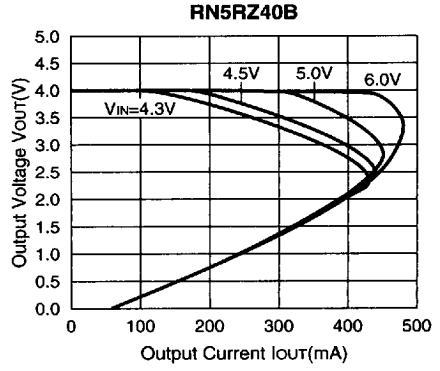
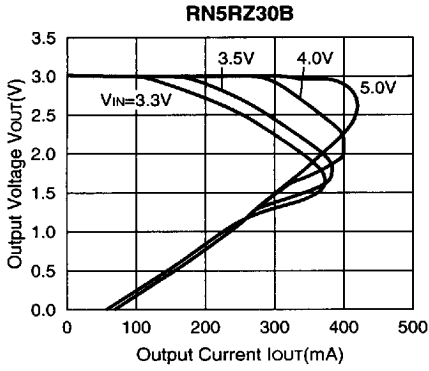

2) Output Voltage vs. Input Voltage

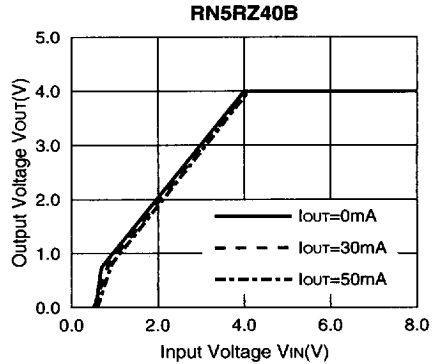
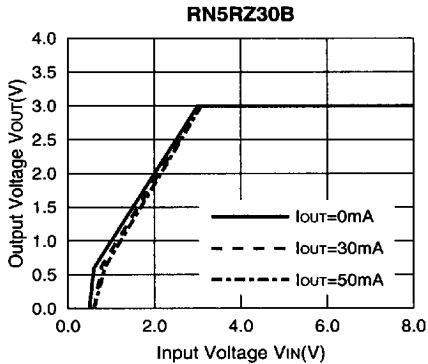

7744690 0004010 203

RICOH

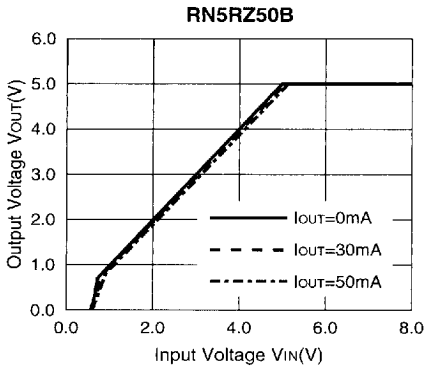

3) Dropout Voltage vs. Output Current

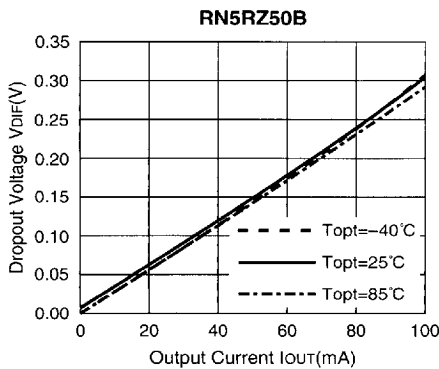
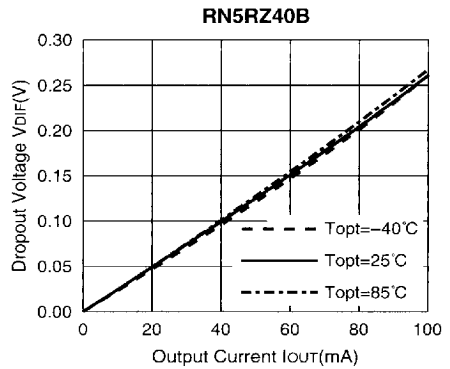
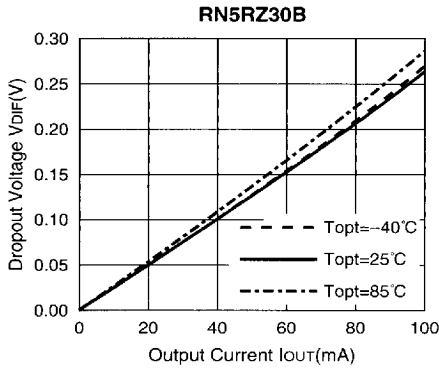

7744690 0004011 14T

RICOH

4) Output Voltage vs. Temperature

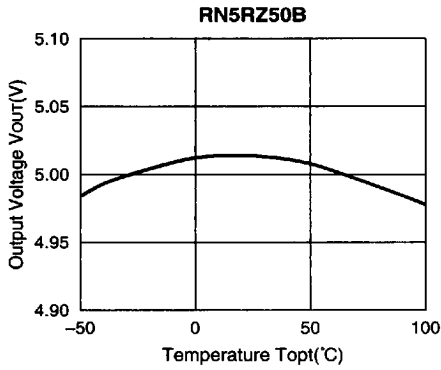
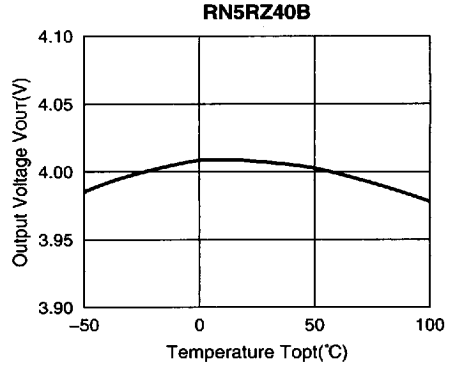
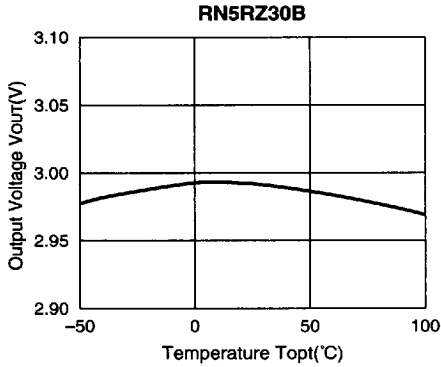

5) Supply Current vs. Input Voltage

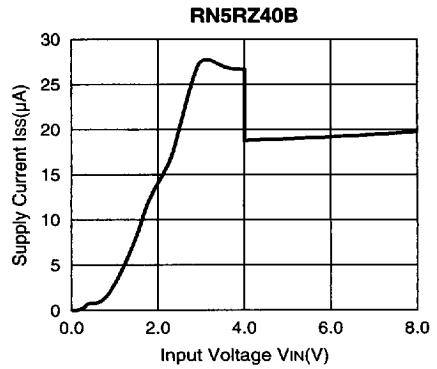
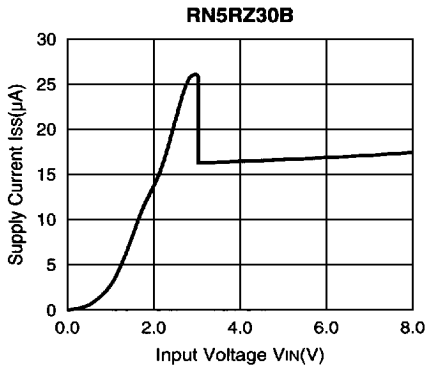

7744690 0004012 086

RICOH

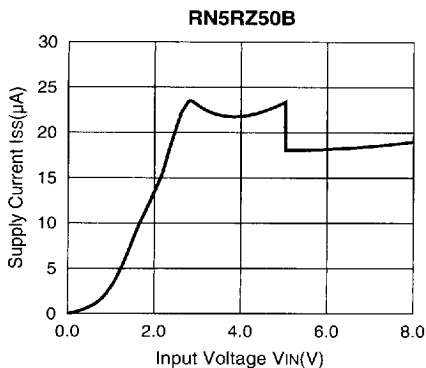

6) Supply Current vs. Temperature

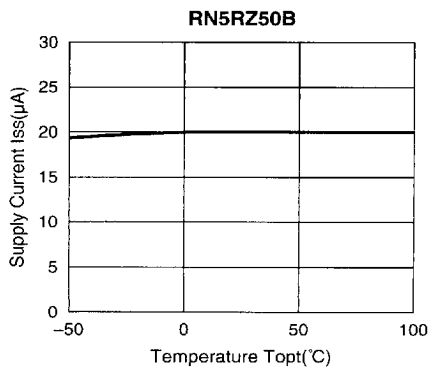
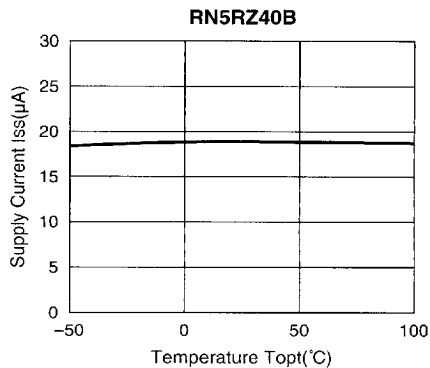
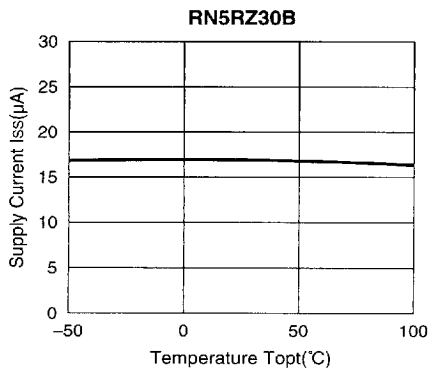

7744690 0004013 T12

RICOH

7) Dropout Voltage vs. Set Output Voltage

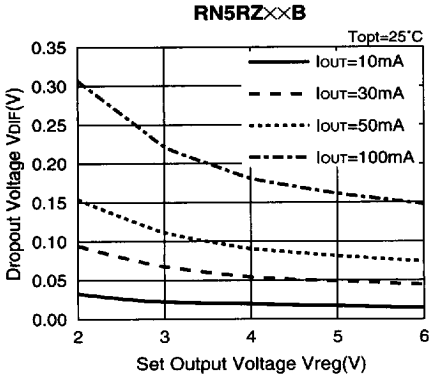

8) Ripple Rejection vs. Frequency

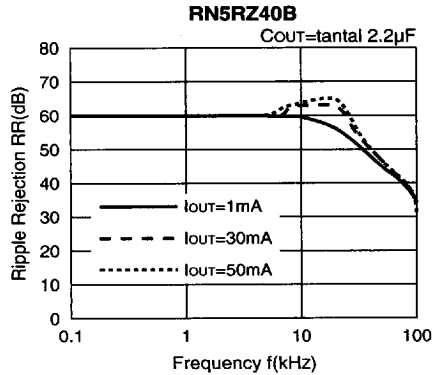
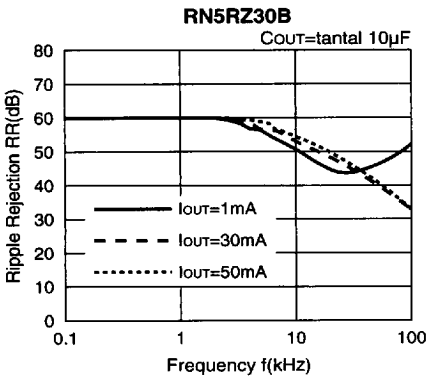
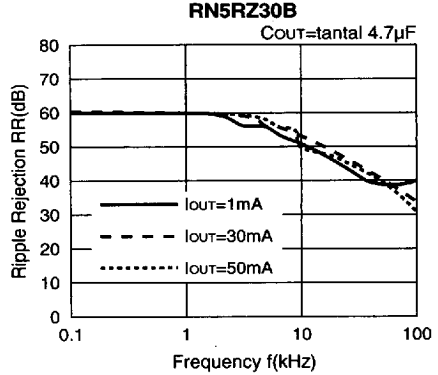
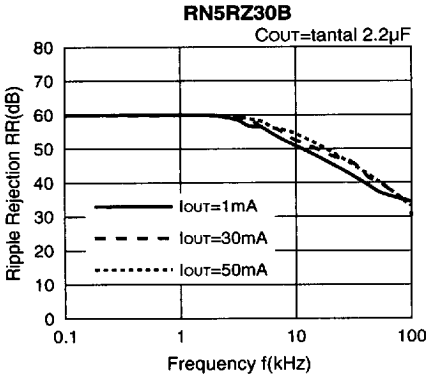

7744690 0004014 959



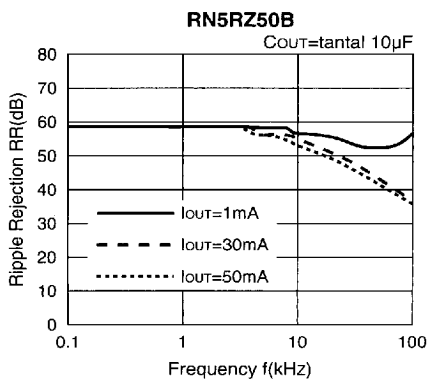
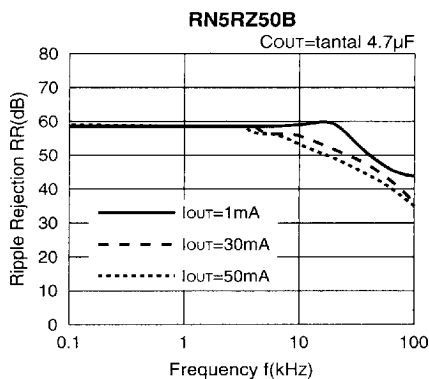
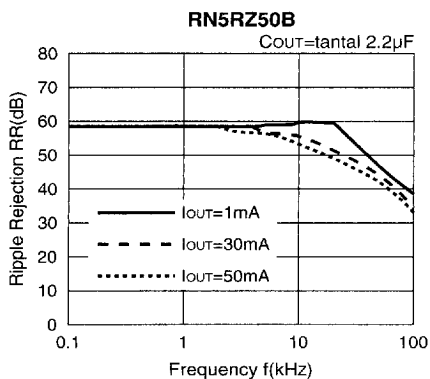
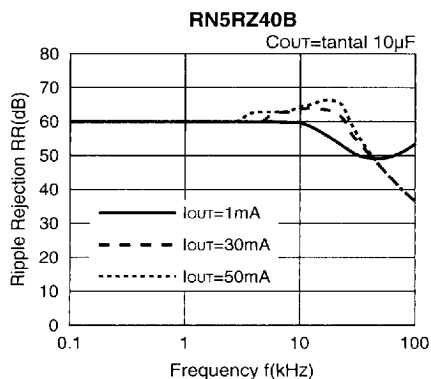
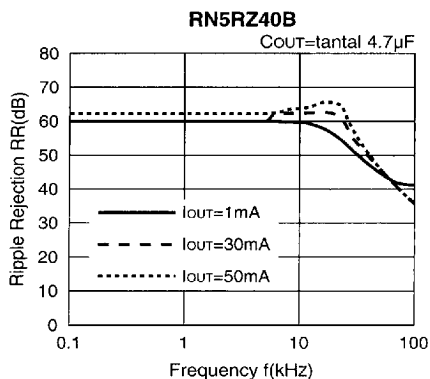

7744690 0004015 895

RICOH

9) Ripple Rejection vs. Input Voltage (DC bias)

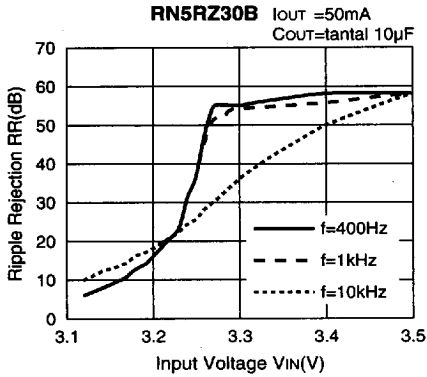
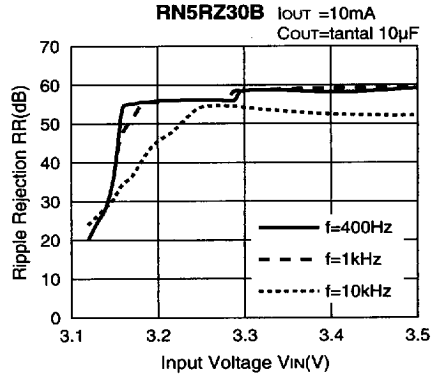
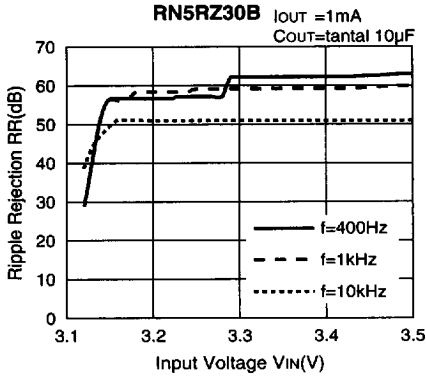

10) Line Transient Response

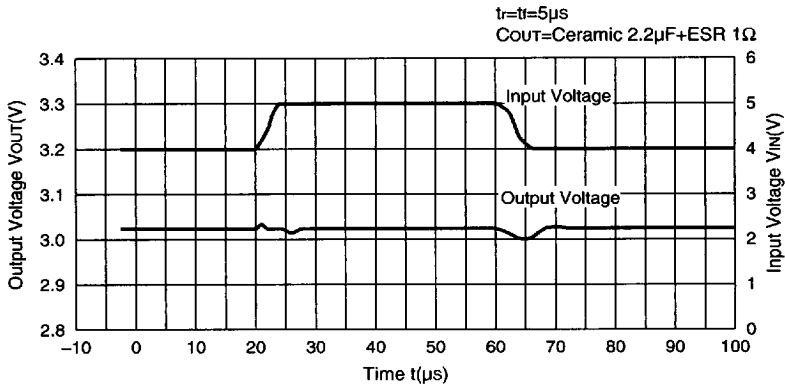

7744690 0004016 721



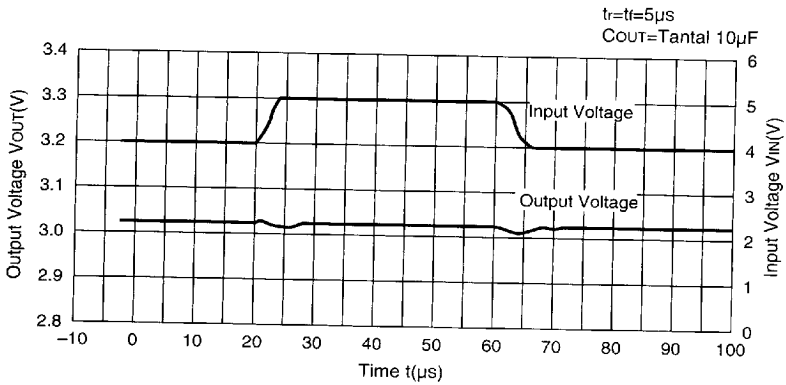
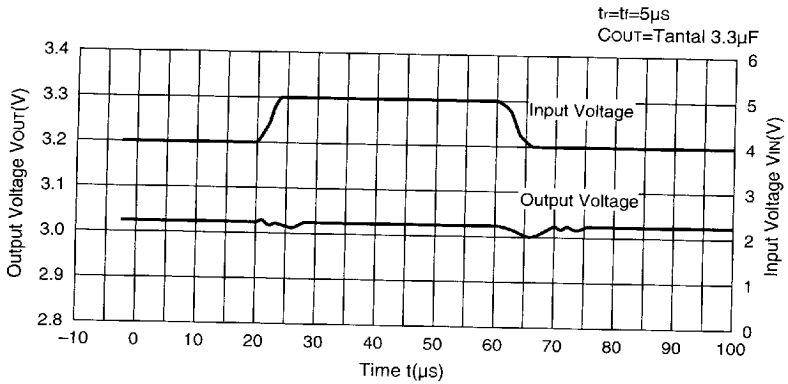

11) Load Transient Response

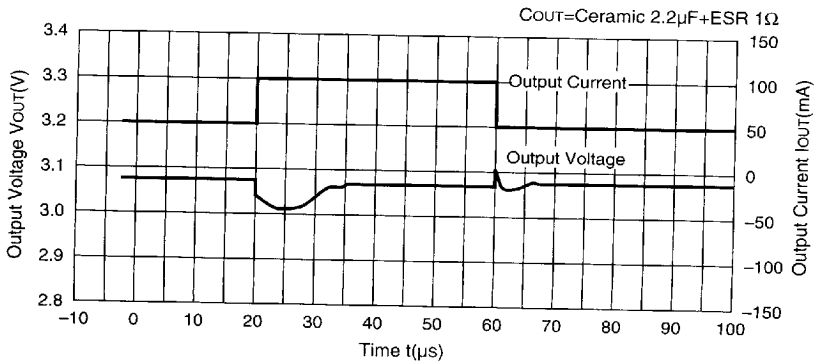

7744690 0004017 668

RICOH

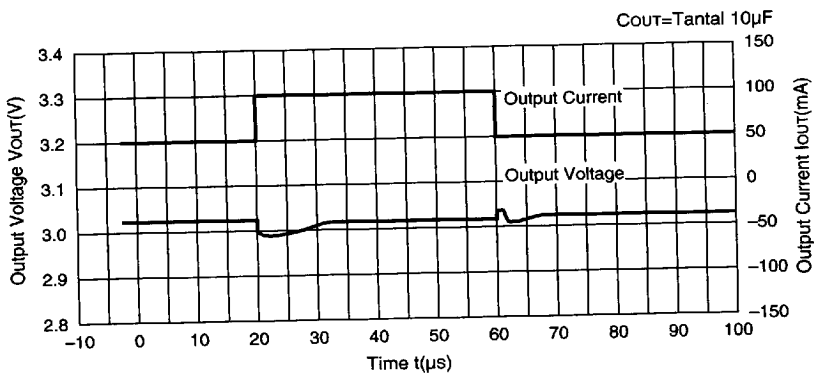
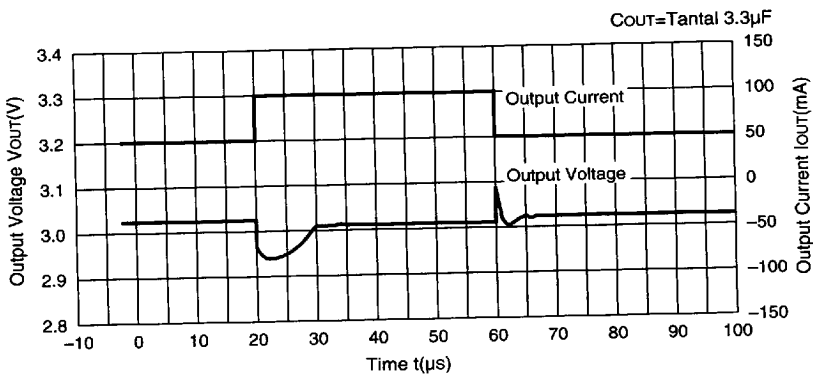
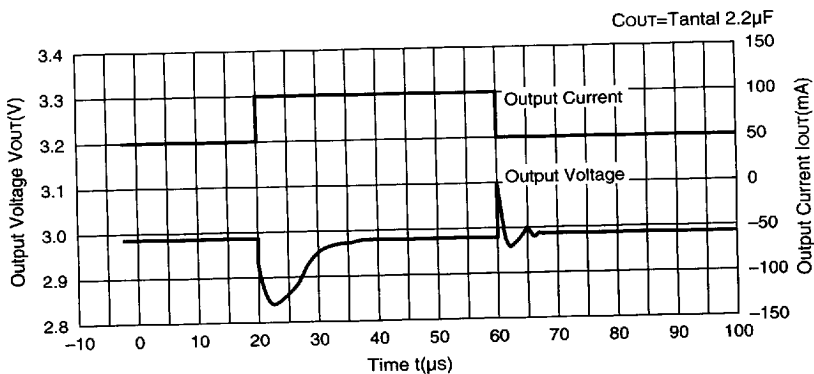

7744690 0004018 5T4

RICOH

FOR STABLE OPERATION

• Countermeasure for Noise

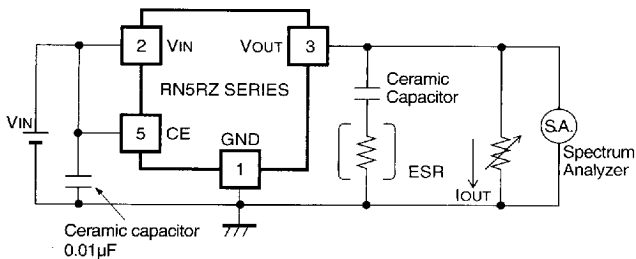

Measuring circuit for white noise ; RN5RZ30B

The relation between output current (I_{OUT}) and Equivalent Series Resistance (ESR) in the output capacitor are described below. The conditions when the noise level is under $40\mu\text{V}$ (Avg.) are marked as the hatched area in the graph.

[Measuring conditions]

Frequency band : 0Hz to 1MHz

Temperature : 25°C

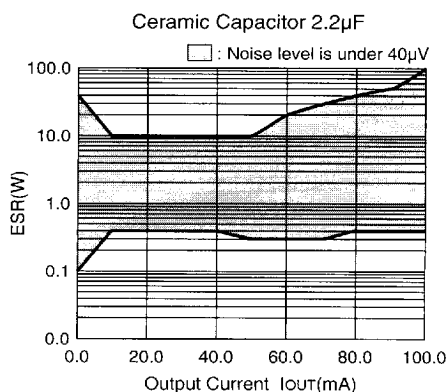
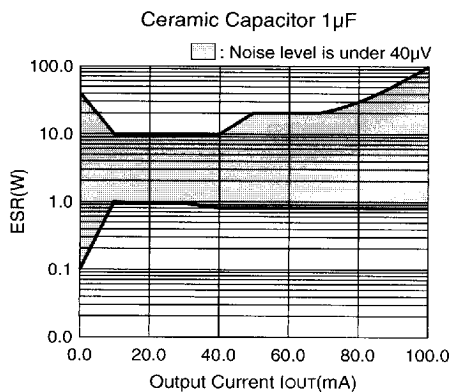

7744690 0004019 430

RICOH

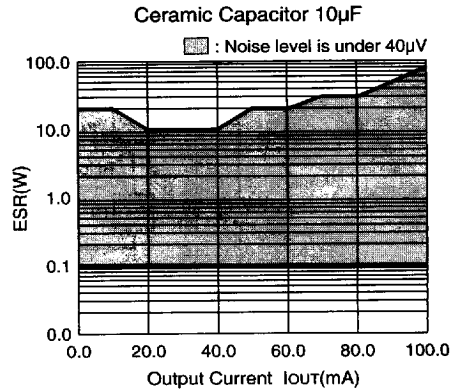
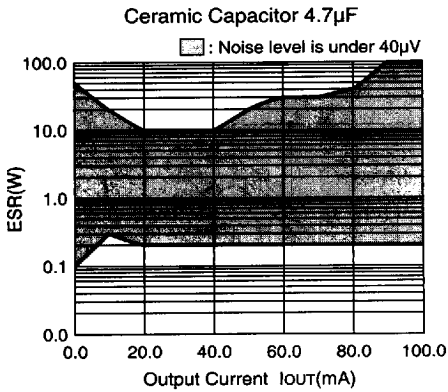

APPLICATION HINTS

When using these ICs, be sure to take care regarding the following points :

- In these ICs, phase compensation is made for securing stable operation even when the load current is varied. For this purpose, be sure to use a capacitor C_{OUT} with good frequency characteristics and ESR in the range described above.
- Make V_{DD} and GND line sufficient. When the impedance of these is high, the noise may be picked up or operation may become unstable.
- Connect the capacitor with a capacitance of about 1 μ F between V_{DD} and GND with wiring as short as possible.
- Set external components as close as possible to the ICs and make wiring short.

7744690 0004020 152

RICOH

POWER DISSIPATION

The power dissipation of RN5RZ series (SOT-23-5) is measured. The measuring conditions as follows:

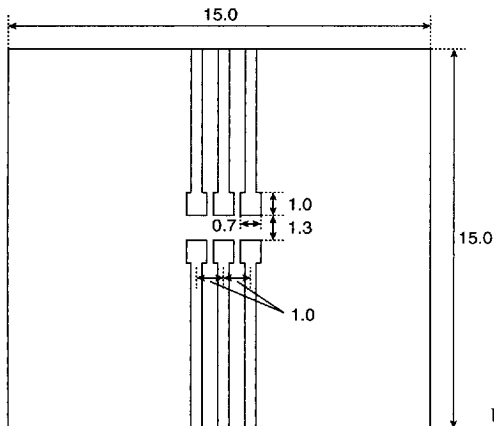

Material : glass cloth epoxy plastic
 Size of the board : 15×15×1.6mm
 Wind velocity : 0m/s
 Mounted with solder

RN5RZ30B(SOT-23-5)

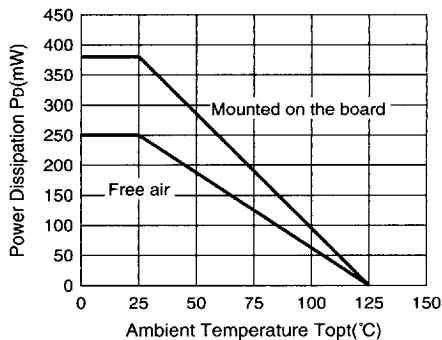

7744690 0004021 099

RICOH