

MAPDCT0030

2 Way 0° Power Divider
5 to 1000 MHz

M/A-COM Products
Released, Rev. V2

Features

- Surface mount
- 2 Way 0 degree.
- 260°C reflow compatible
- RoHS* compliant
- Available on tape and reel.

Description

M/A Com's MAPDCT0030 is a 2 way 0 degree RF power divider in a low cost, surface mount package. Ideally suited for high volume CATV & VSAT applications. Two 0603 1pF capacitors and one 200Ω resistor are required with this part.

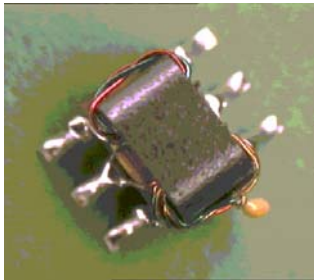

Schematic with off-chip components

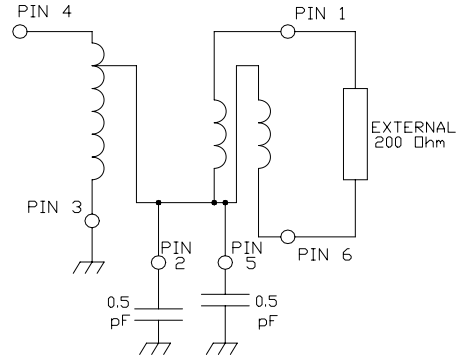

Case style: SM-150

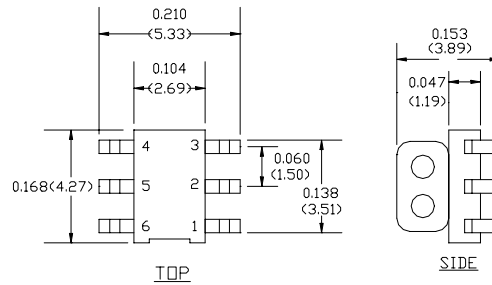

Pin configuration

Pin no.	Function
1	Output 1
2	External 1pF Capacitor to ground
3	Ground
4	Input
5	External 1pF Capacitor to ground
6	Output 2

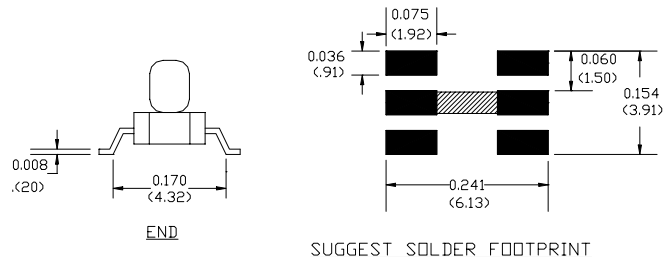

Unless otherwise stated dimensions are in inches [mm]
Tolerance: .xx ± .02, .xxx ± .010

Note: Pin's 2 and 5 need to be connected together on the PCB as shown above.

Ordering information

Part number	Description
MAPDCT0030TR	Reel quantity 1000
MAPD-007985-CT30TB	Customer Test Board

* Restrictions on Hazardous Substances, European Union Directive 2002/95/EC.

Note: Reference Application Note **M513** for reel size information.

ADVANCED: Data Sheets contain information regarding a product M/A-COM is considering for development. Performance is based on target specifications, simulated results, and/or prototype measurements. Commitment to develop is not guaranteed.

PRELIMINARY: Data Sheets contain information regarding a product M/A-COM has under development. Performance is based on engineering tests. Specifications are typical. Mechanical outline has been fixed. Engineering samples and/or test data may be available. Commitment to produce in volume is not guaranteed.

- **North America** Tel: 800.366.2266 / Fax: 978.366.2266
- **Europe** Tel: 44.1908.574.200 / Fax: 44.1908.574.300
- **Asia/Pacific** Tel: 81.44.844.8296 / Fax: 81.44.844.8298

Visit www.macom.com for additional data sheets and product information.

M/A-COM Inc. and its affiliates reserve the right to make changes to the product's or information contained herein without notice.

2 Way 0° Power Divider
5 to 1000 MHz

M/A-COM Products
Released, Rev. V2

Electrical specifications: $T_A = 25^\circ\text{C}$, $Z_0 = 75\Omega$, $P_{in} = 0\text{dBm}$

Parameter	Frequency	Units	Min	Typ	Max
Insertion Loss (Above 3dB)	5 - 400 MHz	dB	-	0.3	0.5
	400 - 820 MHz	dB	-	0.5	1.1
	820 - 1000 MHz	dB	-	1.1	2.2
Amplitude Unbalance	5 - 400 MHz	dB	-	0.2	± 0.5
	400 - 820 MHz	dB	-	0.2	± 0.3
	820 - 1000 MHz	dB	-	0.4	± 0.9
Phase Unbalance	5 - 400 MHz	°	-	0.5	± 4
	400 - 820 MHz	°	-	1.0	± 4
	820 - 1000 MHz	°	-	1.5	± 6
Return Loss: Input	5 - 400 MHz	dB	23	35	-
	400 - 820 MHz	dB	16	22	-
	820 - 1000 MHz	dB	17	24	-
Isolation (between outputs)	5 - 400 MHz	dB	18	35	-
	400 - 820 MHz	dB	20	32	-
	820 - 1000 MHz	dB	14	20	-

www.DataSheet4U.com

Absolute maximum ratings^{1 2}

Parameter	Absolute maximum
Max input power	1W
Internal Load Dissipation	0.125W
Operating temperature	-40°C to +80°C
Storage temperature	-40°C to +85°C

- Exceeding any one or combination of these limits may cause permanent damage to this device.
- M/A-COM does not recommend sustained operation near these survivability limits.

2

ADVANCED: Data Sheets contain information regarding a product M/A-COM is considering for development. Performance is based on target specifications, simulated results, and/or prototype measurements. Commitment to develop is not guaranteed.

PRELIMINARY: Data Sheets contain information regarding a product M/A-COM has under development. Performance is based on engineering tests. Specifications are typical. Mechanical outline has been fixed. Engineering samples and/or test data may be available. Commitment to produce in volume is not guaranteed.

- **North America** Tel: 800.366.2266 / Fax: 978.366.2266
- **Europe** Tel: 44.1908.574.200 / Fax: 44.1908.574.300
- **Asia/Pacific** Tel: 81.44.844.8296 / Fax: 81.44.844.8298

Visit www.macom.com for additional data sheets and product information.

M/A-COM Inc. and its affiliates reserve the right to make changes to the product's or information contained herein without notice.

2 Way 0° Power Divider
5 to 1000 MHz

M/A-COM Products
Released, Rev. V2

Typical performance curves: $T_A = 25^\circ\text{C}$, $Z_0 = 75\Omega$, $P_{in} = 0\text{dBm}$

Insertion loss 1: pin 4 to pin 1

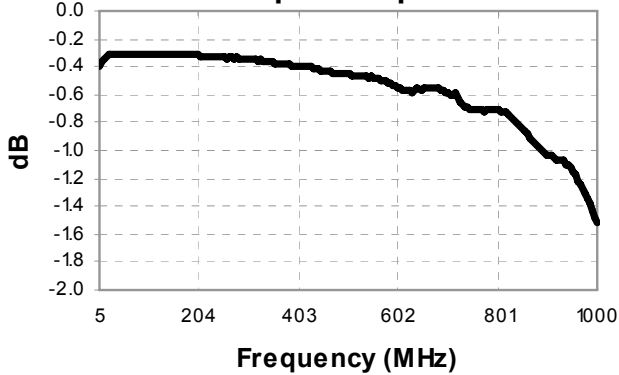

Insertion loss 2: pin 4 to pin 6

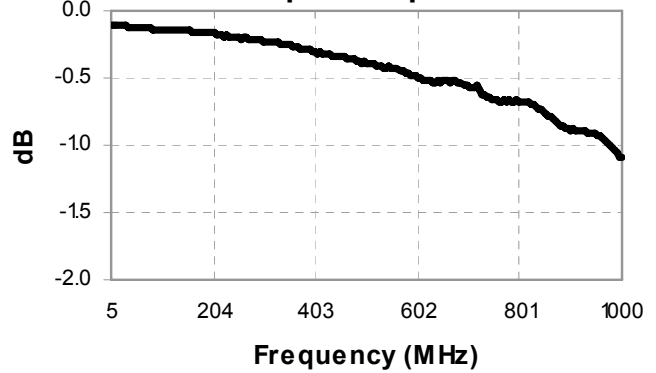

Amplitude balance

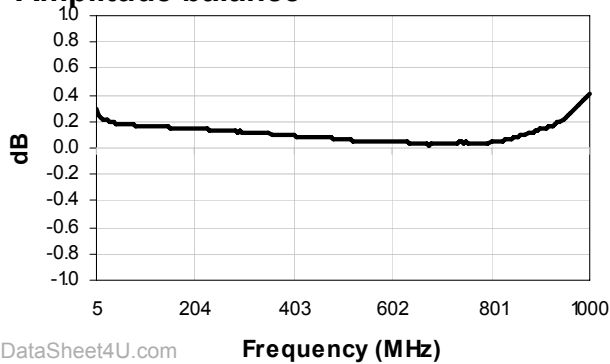

Phase balance

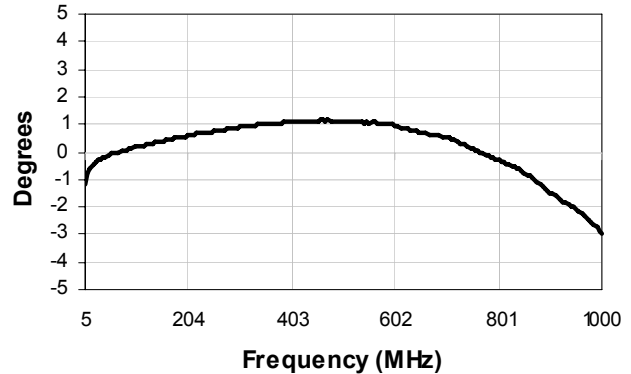

www.DataSheet4U.com

Return loss: Input

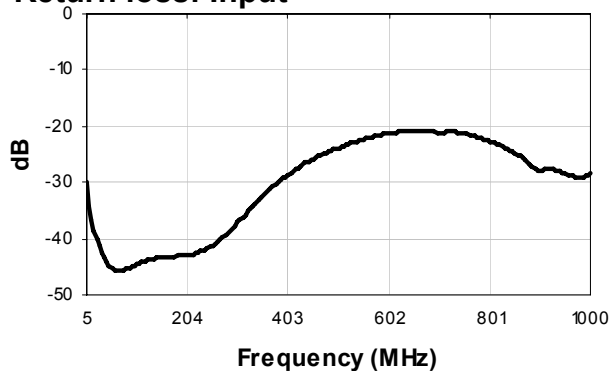

Isolation

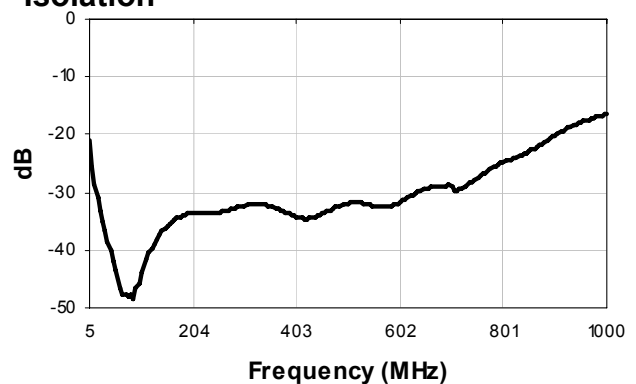

ADVANCED: Data Sheets contain information regarding a product M/A-COM is considering for development. Performance is based on target specifications, simulated results, and/or prototype measurements. Commitment to develop is not guaranteed.

PRELIMINARY: Data Sheets contain information regarding a product M/A-COM has under development. Performance is based on engineering tests. Specifications are typical. Mechanical outline has been fixed. Engineering samples and/or test data may be available. Commitment to produce in volume is not guaranteed.

- **North America** Tel: 800.366.2266 / Fax: 978.366.2266
- **Europe** Tel: 44.1908.574.200 / Fax: 44.1908.574.300
- **Asia/Pacific** Tel: 81.44.844.8296 / Fax: 81.44.844.8298

Visit www.macom.com for additional data sheets and product information.

M/A-COM Inc. and its affiliates reserve the right to make changes to the product's or information contained herein without notice.