

# RF MOSFET Power Transistor, 40W, 28V

## 2 - 175 MHz

# DU2840S

V2.00

### Features

- N-Channel Enhancement Mode Device
- DMOS Structure
- Lower Capacitances for Broadband Operation
- High Saturated Output Power
- Lower Noise Figure Than Bipolar Devices

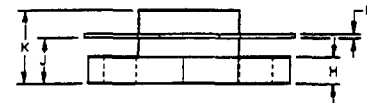
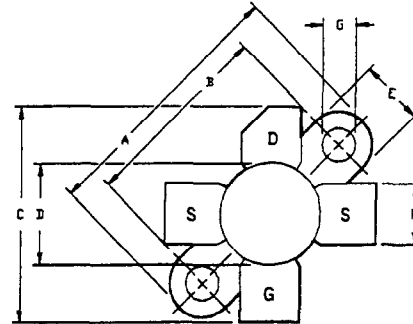

### Absolute Maximum Ratings at 25°C

Parameter	Symbol	Rating	Units
Drain-Source Voltage	$V_{DS}$	65	V
Gate-Source Voltage	$V_{GS}$	20	V
Drain-Source Current	$I_{DS}$	8	A
Power Dissipation	$P_D$	125	W
Junction Temperature	$T_J$	200	°C
Storage Temperature	$T_{STG}$	-55 to +150	°C
Thermal Resistance	$\theta_{JC}$	1.4	°C/W

LETTER DIM	MILLIMETERS		INCHES	
	MIN	MAX	MIN	MAX
A	24.64	24.89	.970	.980
B	18.29	18.54	.720	.730
C	20.07	20.83	.790	.820
D	9.47	9.73	.373	.383
E	6.22	6.48	.245	.255
F	5.64	5.79	.222	.228
G	2.92	3.30	.115	.130
H	2.29	2.67	.090	.105
J	4.04	4.55	.159	.179
K	6.58	7.39	.259	.291
L	.10	.15	.004	.006

### Electrical Characteristics at 25°C

Parameter	Symbol	Min	Max	Units	Test Conditions
Drain-Source Breakdown Voltage	$BV_{DSS}$	65	-	V	$V_{GS}=0.0\text{ V}$ , $I_{DS}=10.0\text{ mA}$
Drain-Source Leakage Current	$I_{DSS}$	-	2.0	mA	$V_{DS}=28.0\text{ V}$ , $V_{GS}=0.0\text{ V}$
Gate-Source Leakage Current	$I_{GSS}$	-	2.0	$\mu\text{A}$	$V_{GS}=20.0\text{ V}$ , $V_{DS}=0.0\text{ V}$
Gate Threshold Voltage	$V_{GS(TH)}$	2.0	6.0	V	$V_{DS}=10.0\text{ V}$ , $I_{DS}=200.0\text{ mA}$
Forward Transconductance	$G_M$	1	-	S	$V_{DS}=10.0\text{ V}$ , $I_{DS}=2000.0\text{ mA}$ , $\Delta V_{GS}=1.0\text{ V}$ , 80 $\mu\text{s}$ Pulse
Input Capacitance	$C_{ISS}$	-	90	pF	$V_{DS}=28.0\text{ V}$ , $F=1.0\text{ MHz}$
Output Capacitance	$C_{OSS}$	-	80	pF	$V_{DS}=28.0\text{ V}$ , $F=1.0\text{ MHz}$
Reverse Capacitance	$C_{RSS}$	-	16	pF	$V_{DS}=28.0\text{ V}$ , $F=1.0\text{ MHz}$
Power Gain	$G_P$	13	-	dB	$V_{DD}=28.0\text{ V}$ , $I_{DQ}=200\text{ mA}$ , $P_{OUT}=40.0\text{ W}$ , $F=175\text{ MHz}$
Drain Efficiency	$\eta_D$	60	-	%	$V_{DD}=28.0\text{ V}$ , $I_{DQ}=200\text{ mA}$ , $P_{OUT}=40.0\text{ W}$ , $F=175\text{ MHz}$
Load Mismatch Tolerance	VSWR-T	-	30:1	-	$V_{DD}=28.0\text{ V}$ , $I_{DQ}=200\text{ mA}$ , $P_{OUT}=40.0\text{ W}$ , $F=175\text{ MHz}$

Specifications Subject to Change Without Notice.

M/A-COM, Inc.

North America: Tel. (800) 366-2266  
Fax (800) 618-8883

Asia/Pacific: Tel. +81 (03) 3226-1671  
Fax +81 (03) 3226-1451

Europe: Tel. +44 (1344) 869 595  
Fax +44 (1344) 300 020

Typical Broadband Performance Curves

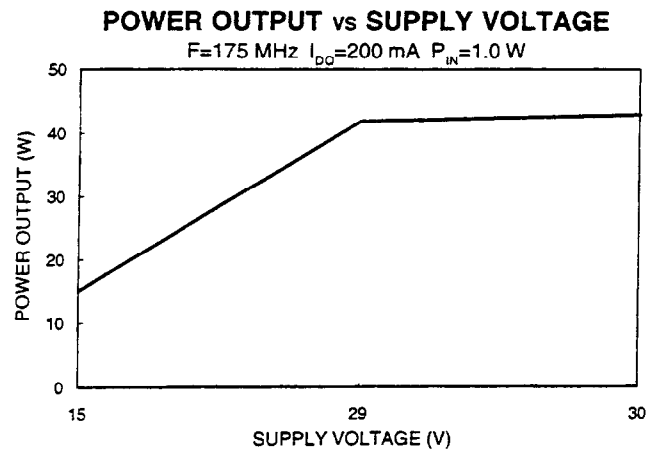
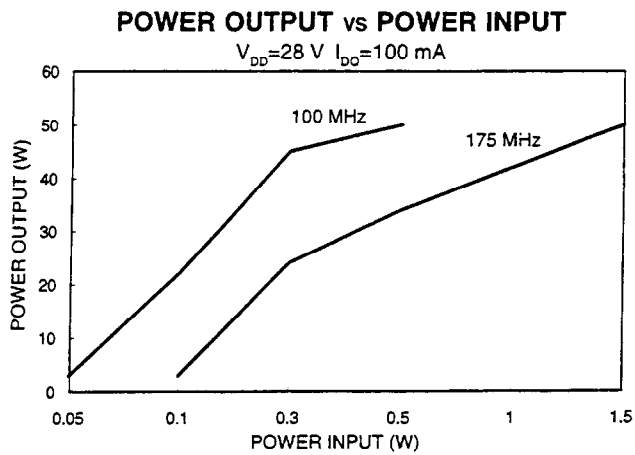
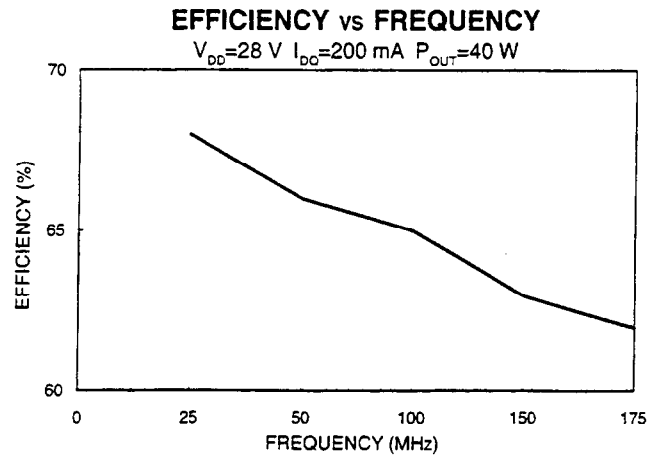
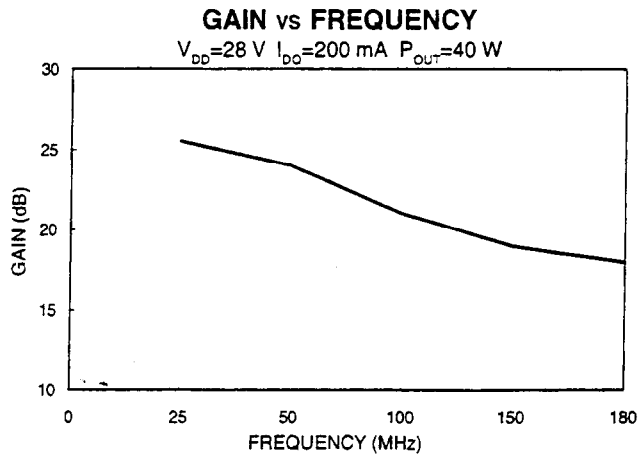

Specifications Subject to Change Without Notice.

M/A-COM, Inc.

North America: Tel. (800) 366-2266  
 Fax (800) 618-8883

■ Asia/Pacific: Tel. +81 (03) 3226-1671  
 Fax +81 (03) 3226-1451

■ Europe: Tel. +44 (1344) 869 595  
 Fax +44 (1344) 300 020

Typical Device Impedance

Frequency (MHz)	Z <sub>IN</sub> (OHMS)	Z <sub>LOAD</sub> (OHMS)
30	12.0 - j 6.8	6.5 - j 1.5
50	10.0 - j 6.5	6.0 - j 1.8
100	6.0 - j 5.5	5.5 - j 1.8
200	1.1 - j 3.0	3.5 - j 1.8

V<sub>DD</sub>=28 V, I<sub>DD</sub>=200 mA, P<sub>OUT</sub>=40 Watts

Z<sub>IN</sub> is the series equivalent input impedance of the device from gate to source.

Z<sub>LOAD</sub> is the series equivalent load impedance as measured from drain to ground.

RF Test Fixture

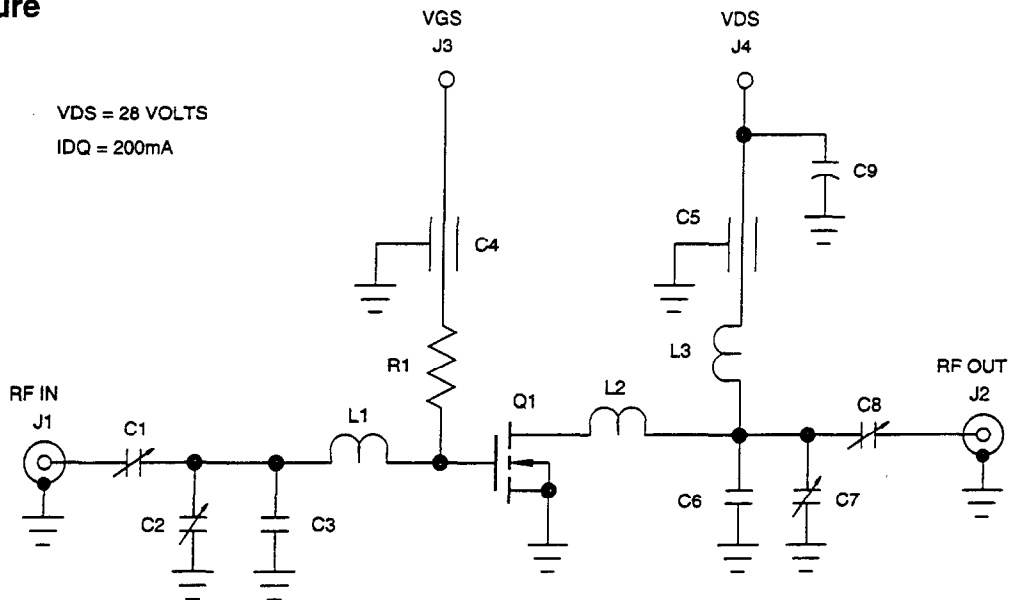

PARTS LIST

C1,C7,C8	TRIMMER CAPACITOR 4-40pF
C2	TRIMMER CAPACITOR 9-180pF
C3,C6	CAPACITOR 50pF
C4,C5	FEEDTHROUGH CAPACITOR 0.004uF
C9	ELECTROLYTIC CAPACITOR 50uF 50 VOLT
L1	NO. 12 AWG COPPER WIRE X 1.25"
L2	NO. 12 AWG COPPER WIRE X 1.50"
L3	8 TURNS OF NO. 22 AWG ENAMEL WIRE ON '0.25", CLOSE WOUND
R1	RESISTOR 100K OHMS
Q1	DU2840S
BOARD	FR4 0.062"

Specifications Subject to Change Without Notice.

M/A-COM, Inc.

North America: Tel. (800) 366-2266  
Fax (800) 618-8883

Asia/Pacific: Tel. +81 (03) 3226-1671  
Fax +81 (03) 3226-1451

Europe: Tel. +44 (1344) 869 595  
Fax +44 (1344) 300 020