



20CTH03
20CTH03S
20CTH03-1
20CTH03FP

Hyperfast Rectifier

Features

- Hyperfast Recovery Time
- Low Forward Voltage Drop
- Low Leakage Current
- 175°C Operating Junction Temperature

$t_{rr} = 35\text{ns max.}$
 $I_{F(AV)} = 20\text{Amp}$
 $V_R = 300\text{V}$

Description/ Applications

International Rectifier's 300V series are the state of the art Hyperfast recovery rectifiers designed with optimized performance of forward voltage drop and Hyperfast recovery time.

The planar structure and the platinum doped life time control guarantee the best overall performance, ruggedness and reliability characteristics.





These devices are intended for use in the output rectification stage of SMPS, UPS, DC-DC converters as well as freewheeling diodes in low voltage inverters and chopper motor drives.

Their extremely optimized stored charge and low recovery current minimize the switching losses and reduce over dissipation in the switching element and snubbers.

Absolute Maximum Ratings

Parameters	Max	Units
V_{RRM} Peak Repetitive Reverse Voltage	300	V
$I_{F(AV)}$ Average Rectified Forward Current @ $T_C = 160^\circ\text{C}$ Per Diode @ $T_C = 135^\circ\text{C}$ (FULLPACK) Per Device	10	A
	20	
I_{FSM} Non Repetitive Peak Surge Current @ $T_J = 25^\circ\text{C}$	120	
T_J, T_{STG} Operating Junction and Storage Temperatures	- 65 to 175	$^\circ\text{C}$

Case Styles

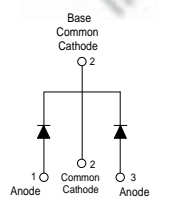
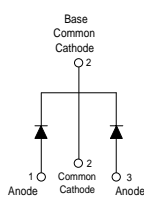
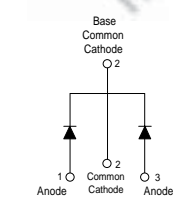
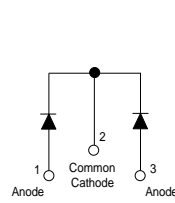
20CTH03	20CTH03S	20CTH03-1	20CTH03FP
			
<p>Base Common Cathode</p>  <p>1 Anode 2 Common Cathode 3 Anode</p> <p>TO-220AB</p>	<p>Base Common Cathode</p>  <p>1 Anode 2 Common Cathode 3 Anode</p> <p>D²PAK</p>	<p>Base Common Cathode</p>  <p>1 Anode 2 Common Cathode 3 Anode</p> <p>TO-262</p>	 <p>1 Anode 2 Common Cathode 3 Anode</p> <p>TO-220 FULLPACK</p>

Electrical Characteristics @ T_J = 25°C (unless otherwise specified)

Parameters	Min	Typ	Max	Units	Test Conditions
V _{BR} , V _F Breakdown Voltage, Blocking Voltage	300	-	-	V	I _R = 100μA
V _F Forward Voltage	-	1.05	1.25	V	I _F = 10A, T _J = 25°C
	-	0.85	0.95	V	I _F = 10A, T _J = 125°C
I _R Reverse Leakage Current	-	-	20	μA	V _R = V _R Rated
	-	6	200	μA	T _J = 125°C, V _R = V _R Rated
C _T Junction Capacitance	-	30	-	pF	V _R = 300V
L _S Series Inductance	-	8	-	nH	Measured lead to lead 5mm from package body

Dynamic Recovery Characteristics @ T_C = 25°C (unless otherwise specified)

Parameters	Min	Typ	Max	Units	Test Conditions
t _{rr} Reverse Recovery Time	-	-	35	ns	I _F = 1A, di _F /dt = 50A/μs, V _R = 30V
	-	-	30		I _F = 1A, di _F /dt = 100A/μs, V _R = 30V
	-	31	-	ns	T _J = 25°C
	-	42	-		T _J = 125°C
I _{RRM} Peak Recovery Current	-	2.4	-	A	T _J = 25°C
	-	5.6	-		T _J = 125°C
Q _{rr} Reverse Recovery Charge	-	36	-	nC	T _J = 25°C
	-	120	-		T _J = 125°C

I_F = 10A
di_F/dt = 200A/μs
V_R = 200V

Thermal - Mechanical Characteristics

Parameters	Min	Typ	Max	Units
T _J Max. Junction Temperature Range	-	-	175	°C
T _{Stg} Max. Storage Temperature Range	- 65	-	175	
R _{thJC} Thermal Resistance, Junction to Case	-	-	1.5	°C/W
	-	-	3.9	

Per Diode
Fullpack (Per Diode)

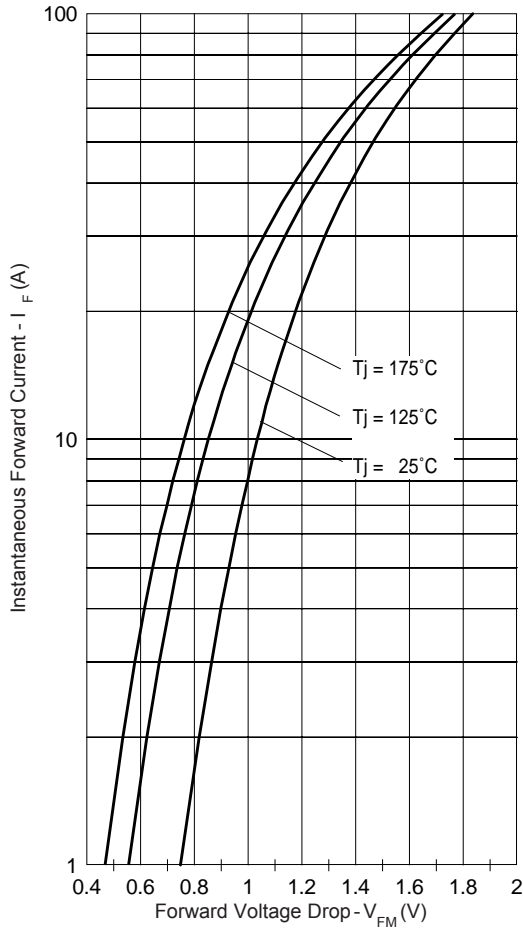

Fig. 1 - Typical Forward Voltage Drop Characteristics

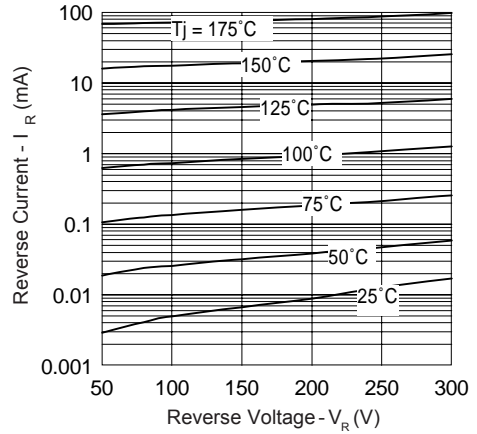

Fig. 2 - Typical Values of Reverse Current Vs. Reverse Voltage

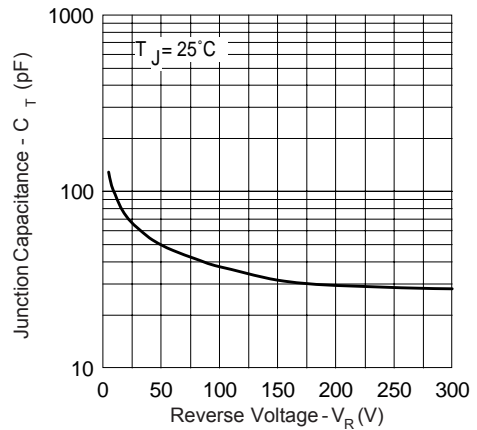

Fig. 3 - Typical Junction Capacitance Vs. Reverse Voltage

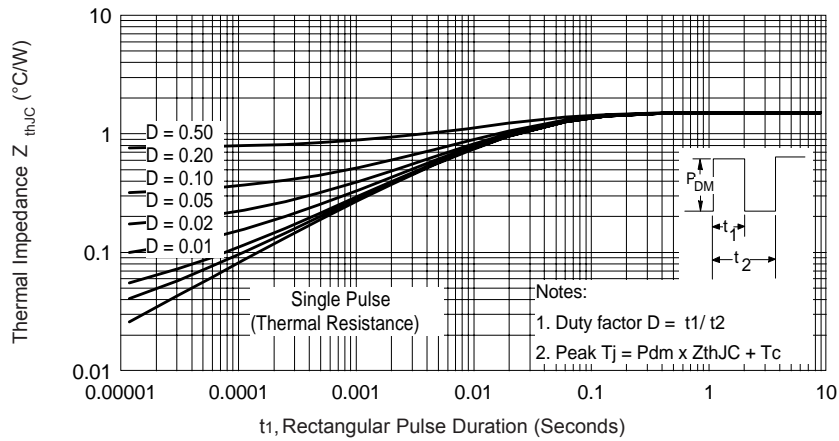

Fig. 4 - Max. Thermal Impedance Z_{thJC} Characteristics

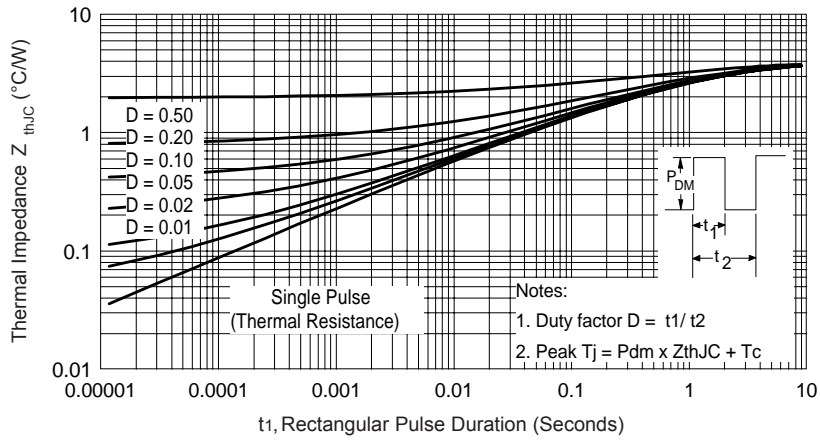

Fig. 5 - Max. Thermal Impedance Z_{thJC} Characteristics (FULLPACK)

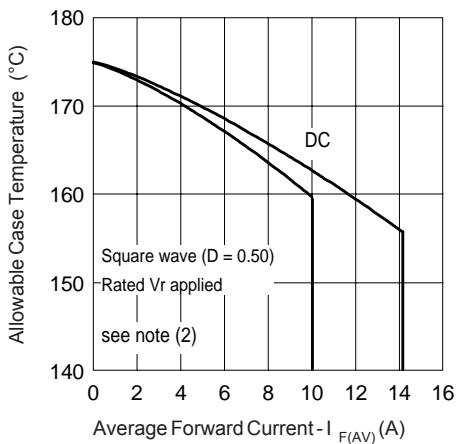

Fig. 6 - Max. Allowable Case Temperature Vs. Average Forward Current

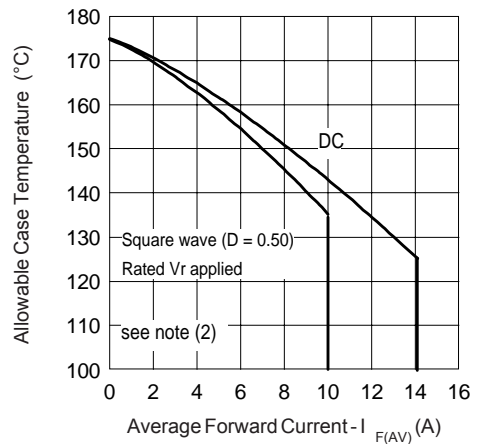

Fig. 7 - Max. Allowable Case Temperature Vs. Average Forward Current (FULLPACK)

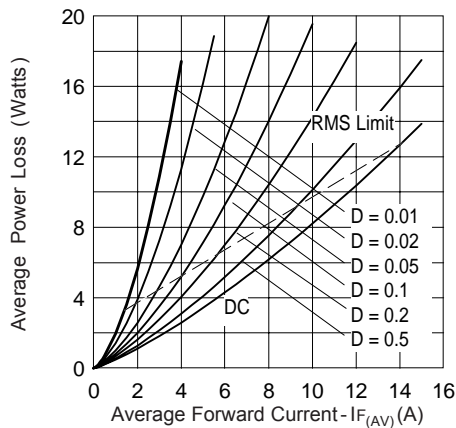

Fig. 8 - Forward Power Loss Characteristics

- (2) Formula used: $T_c = T_j - (Pd + Pd_{REV}) \times R_{thJC}$;
 $Pd = \text{Forward Power Loss} = I_{F(AV)} \times V_{FM} @ (I_{F(AV)}/D)$
 (see Fig. 8);
 $Pd_{REV} = \text{Inverse Power Loss} = V_{R1} \times I_R (1-D)$;
 $I_R @ V_{R1} = \text{rated } V_R$

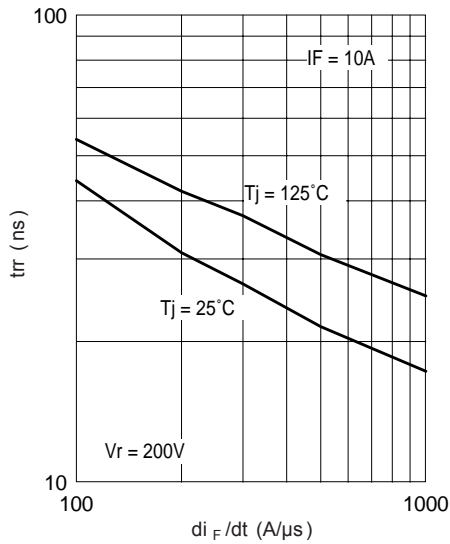

Fig. 9 - Typical Reverse Recovery vs. di_F/dt

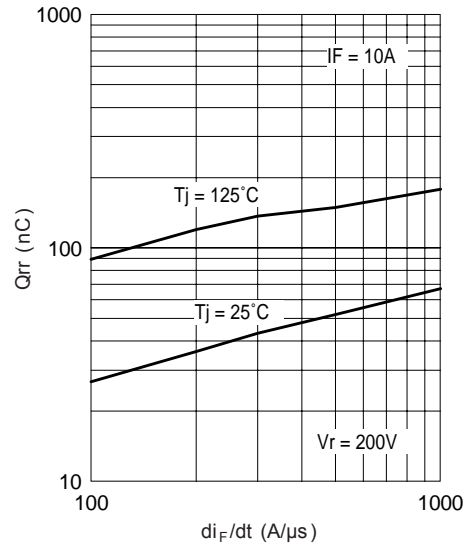

Fig. 10 - Typical Stored Charge vs. di_F/dt

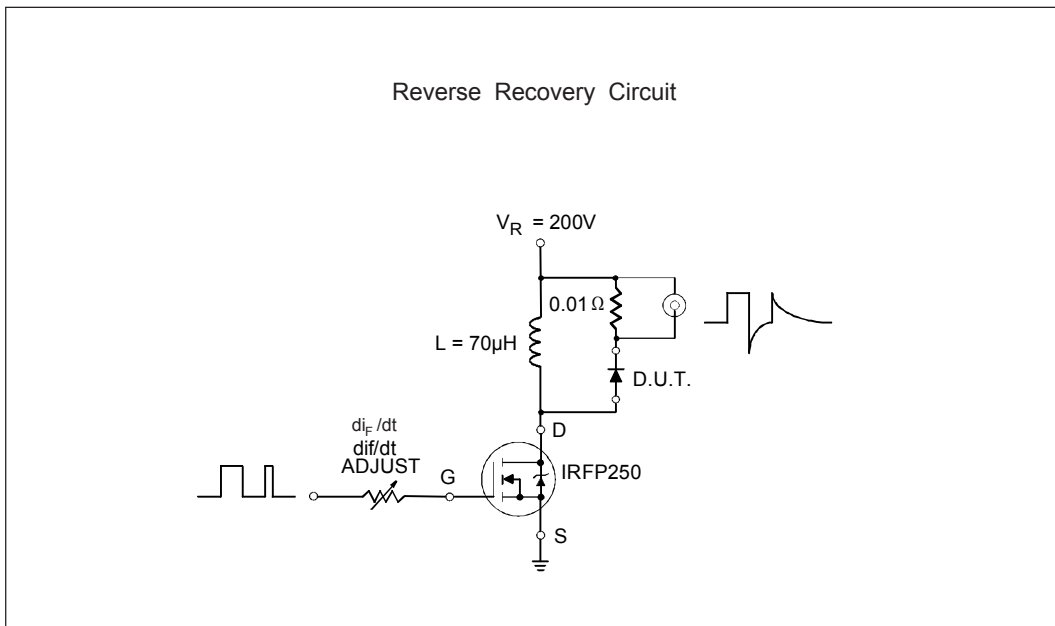

Fig. 11 - Reverse Recovery Parameter Test Circuit

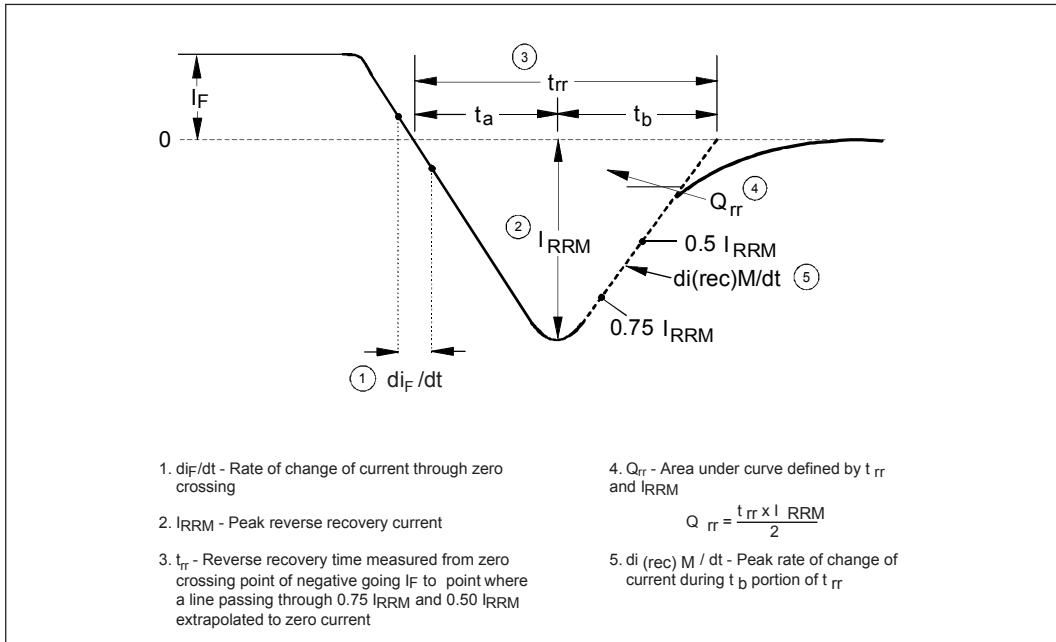
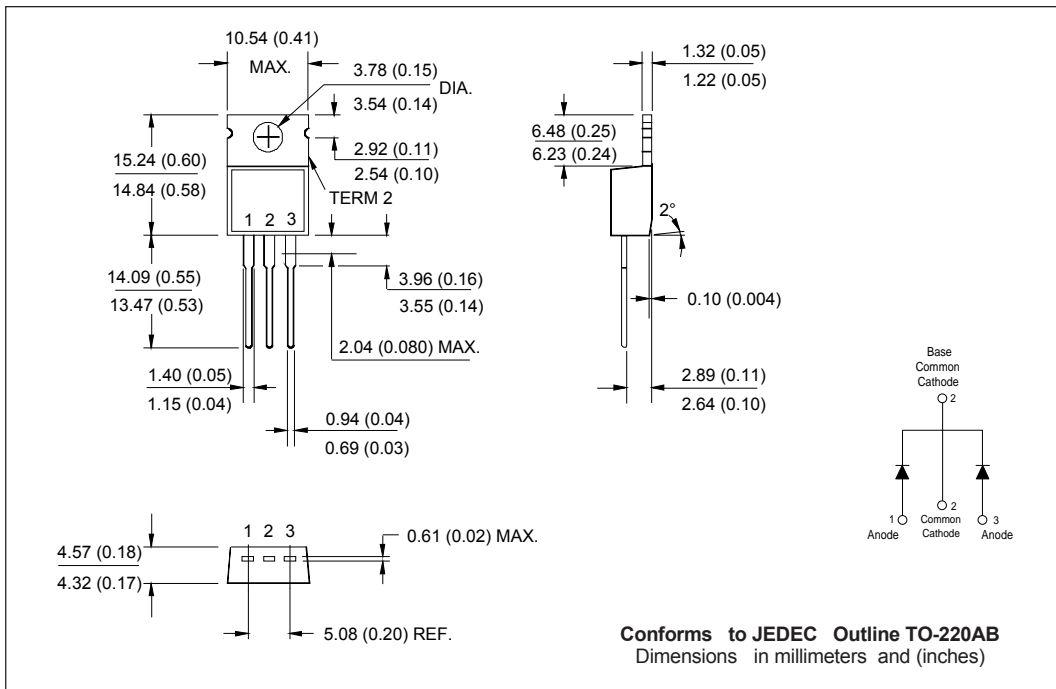
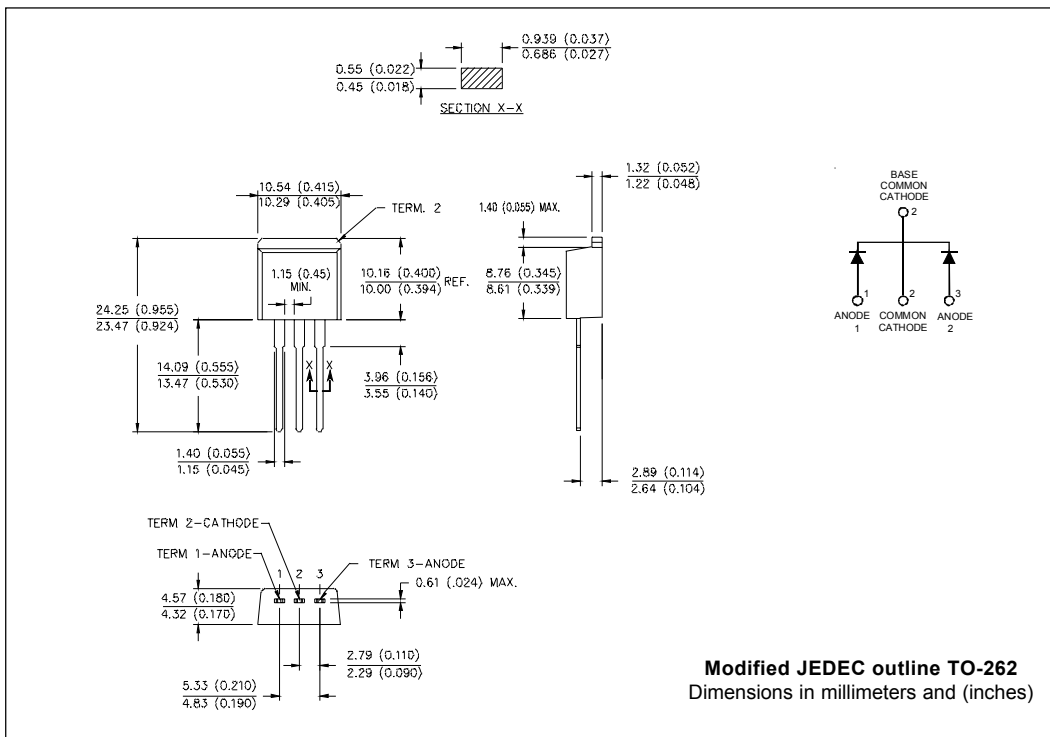
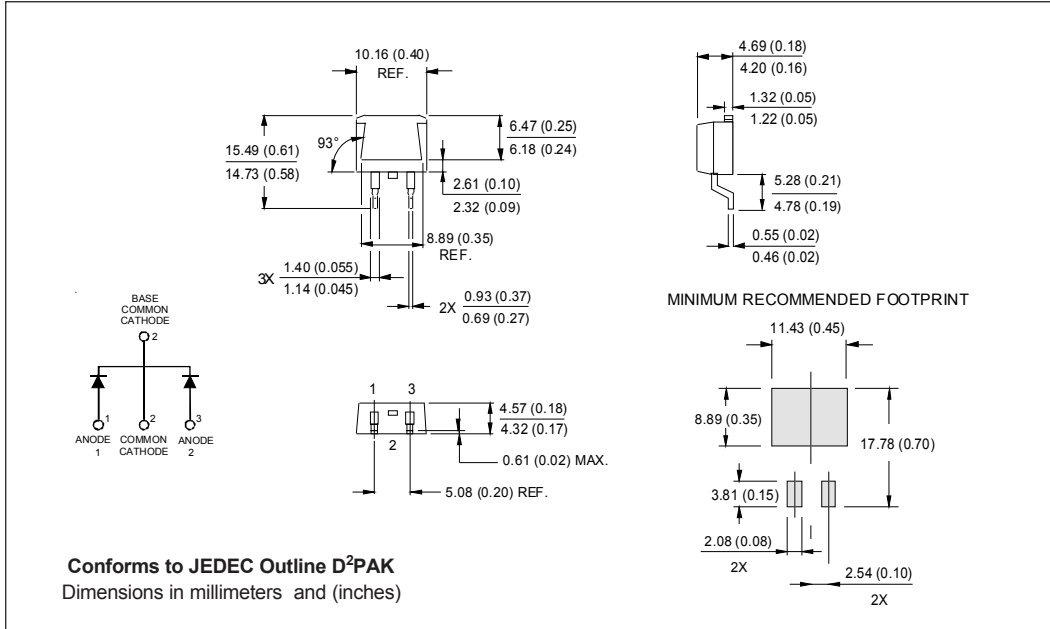

Fig. 13 - Reverse Recovery Waveform and Definitions

Outline Table



Outline Table



Outline Table

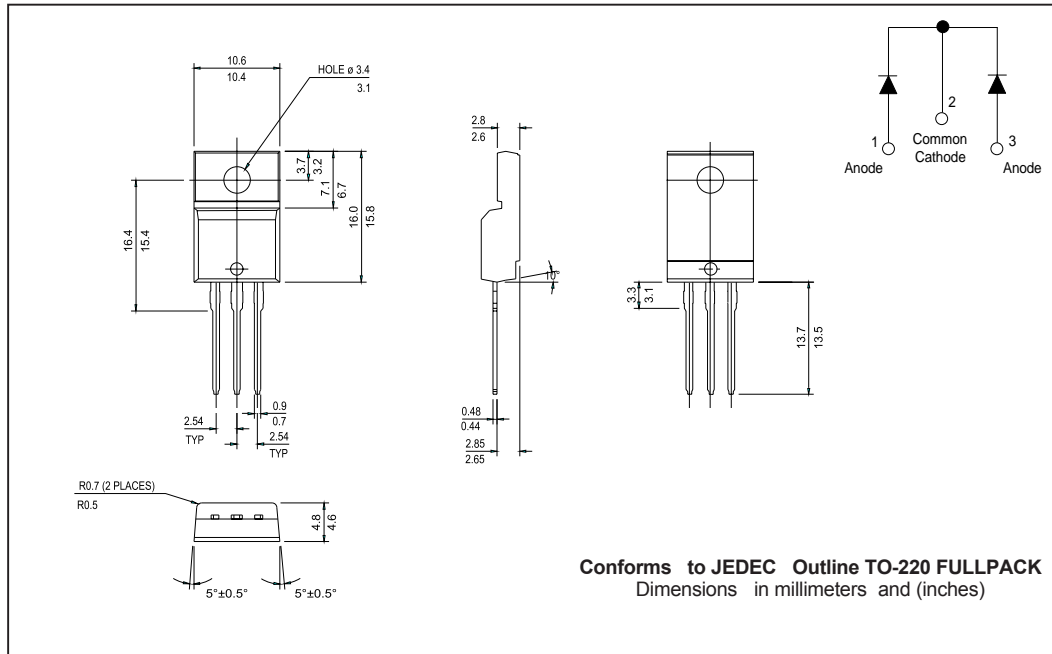

Ordering Information Table

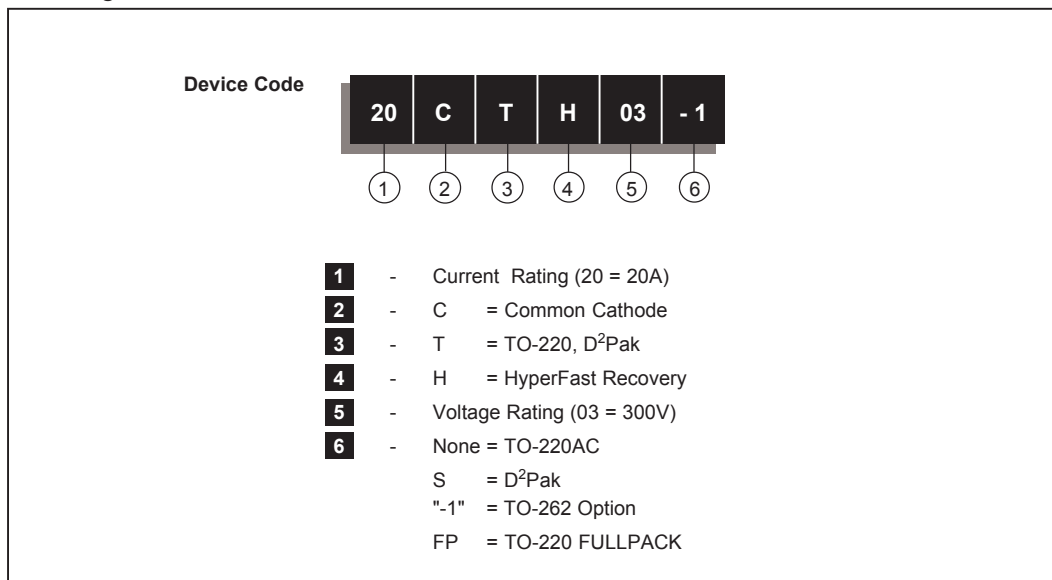

Data and specifications subject to change without notice.
This product has been designed and qualified for Industrial Level.
Qualification Standards can be found on IR's Web site.

International
IOR Rectifier

IR WORLD HEADQUARTERS: 233 Kansas St., El Segundo, California 90245, USA Tel: (310) 252-7105
TAC Fax: (310) 252-7309
Visit us at www.irf.com for sales contact information. 08/03