



Pb-free
HEAT



105/107 Series

Numeric Display/Case Size 22.8 x 33.0 mm

Features

| | |
|-------------------|--|
| Case Size | 22.8 x 33.0 mm (W x H) |
| Product features | <ul style="list-style-type: none"> ▪ Each color has anode common and cathode common respectively. ▪ A black case and a gray case are available. ▪ No lead package ▪ Lead-free soldering compatible ▪ RoHS compliant |
| Peak wavelength | Green : 565nm Orange : 605nm Red : 660nm |
| Number of Digit | 1 Digit |
| Segment Shape | Arrow Feather Type |
| Character Height | 25.4 mm |
| Die materials | Green : GaP Orange : GaAsP Red : GaAlAs |
| Soldering methods | TTW (Through The Wave) soldering and manual soldering |
| ESD | More than 2kV(HBM) |
| Packing | Tray |

Recommended Applications

Amusement Equipment, Electric Household Appliances, Other General Applications

Emitted Color

| Part No. | | | | Material | Emitted Color | ※1 Chip/ Segment |
|---------------------|--------------------|---------------------|--------------------|----------|---------------|------------------------|
| Anode Common | | Cathode Common | | | | |
| Case Color Black | Case Color Gray | Case Color Black | Case Color Gray | | | |
| NAG105P | NAG107P | NKG105P | NKG107P | GaP | Green | 2 |
| | | | | | | 1 |
| NAA105 | NAA107 | NKA105 | NKA107 | GaAsP | Orange | 2 |
| | | | | | | 1 |
| NAR105 | NAR107 | NKR105 | NKR107 | GaAlAs | Red | 2 |
| | | | | | | 1 |

※1 Segment NO. a, b, c, d, e, f, g : 2 chips / Segment
 Segment NO. D.P : 1 chip / Segment

Absolute Maximum Ratings

(Ta=25°C)

| Item | Symbol | Absolute Maximum Ratings | | | | | | Unit |
|---------------------------------|-------------------|--------------------------|----|---------|----|---------|----|--------|
| | | Green | | Orange | | Red | | |
| | | Chip / Segment | | | | | | |
| | | 2 | 1 | 2 | 1 | 2 | 1 | |
| Power Dissipation | Pd | 126 | 63 | 126 | 63 | 120 | 60 | mW/seg |
| Forward Current | I _F | 25 | | 25 | | 30 | | mA/seg |
| Pulse Forward Current ※2 | I _{FRM} | 100 | | 100 | | 120 | | mA/seg |
| Derating (Ta=25°C or higher) | ΔI _F | 0.34 | | 0.34 | | 0.41 | | mA/°C |
| | ΔI _{FRM} | 1.35 | | 1.35 | | 1.64 | | mA/°C |
| Reverse Voltage | V _R | 8 | 4 | 8 | 4 | 8 | 4 | V |
| Operating Temperature | T _{opr} | -20~+85 | | -20~+85 | | -20~+85 | | °C |
| Storage Temperature | T _{stg} | -20~+85 | | -20~+85 | | -20~+85 | | °C |

※2 I_{FRM} Measurement condition : Duty 1/5, f = 1kHz

Electro-Optical Characteristics

(Ta=25°C)

| Item | Conditions | Symbol | | Characteristics | | | | | | Unit |
|----------------------------|----------------------|----------------|------|-----------------|-----|--------|-----|-----|------|---------|
| | | | | Green | | Orange | | Red | | |
| | | | | Chip / Segment | | | | | | |
| | | | | 2 | 1 | 2 | 1 | 2 | 1 | |
| Luminous Intensity(Rank B) | I _F =20mA | I _V | MIN. | 4 | 2 | 8 | 4 | 10 | 5 | mcd/seg |
| | | | TYP. | 8 | 4 | 16 | 8 | 20 | 10 | |
| Luminous Intensity(Rank C) | I _F =20mA | I _V | MIN. | - | - | - | - | 20 | 10 | mcd/seg |
| | | | TYP. | - | - | - | - | 25 | 12.5 | |
| Forward Voltage | I _F =20mA | V _F | TYP. | 4.4 | 2.2 | 4.4 | 2.2 | 3.4 | 1.7 | V/seg |
| | | | MAX. | 5.0 | 2.5 | 5.0 | 2.5 | 4.0 | 2.0 | |
| Reverse Current | - | I _R | MAX. | 100 | 100 | 100 | 100 | 100 | 100 | μA/seg |
| Peak Wavelength | I _F =20mA | λ _D | TYP. | 565 | | 605 | | 660 | | nm |
| Spectral Line Half Width | I _F =20mA | Δλ | TYP. | 30 | | 30 | | 30 | | nm |

Technical Data(Green)

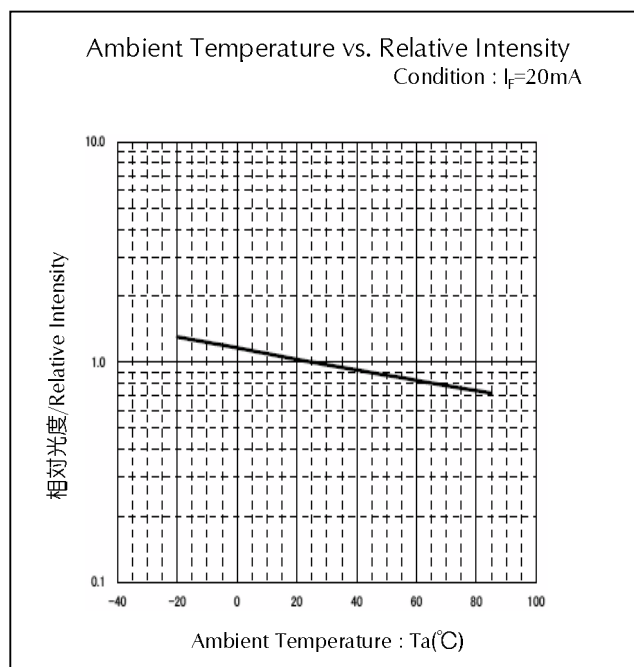
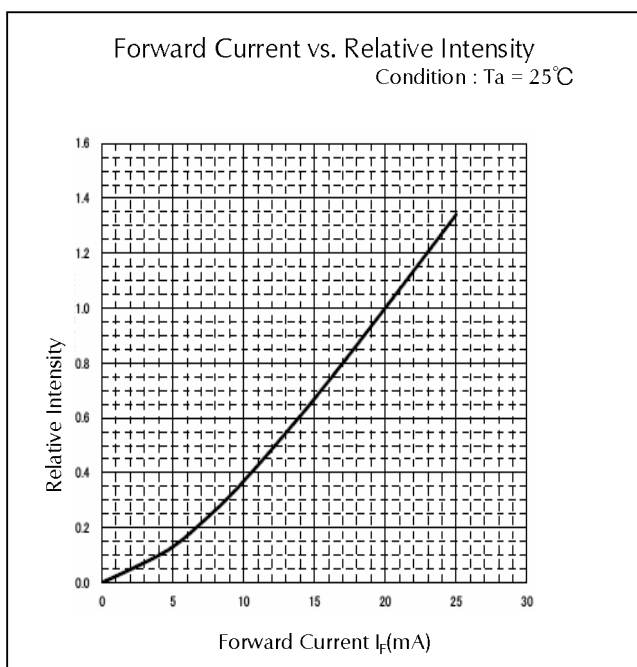
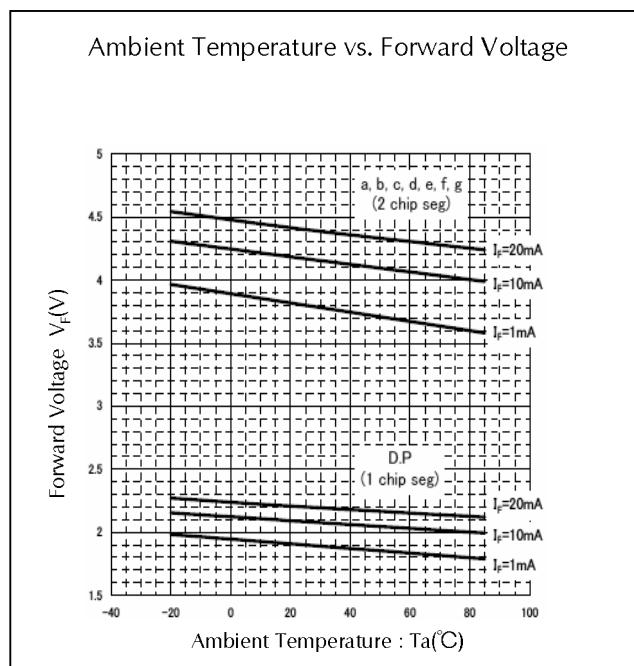
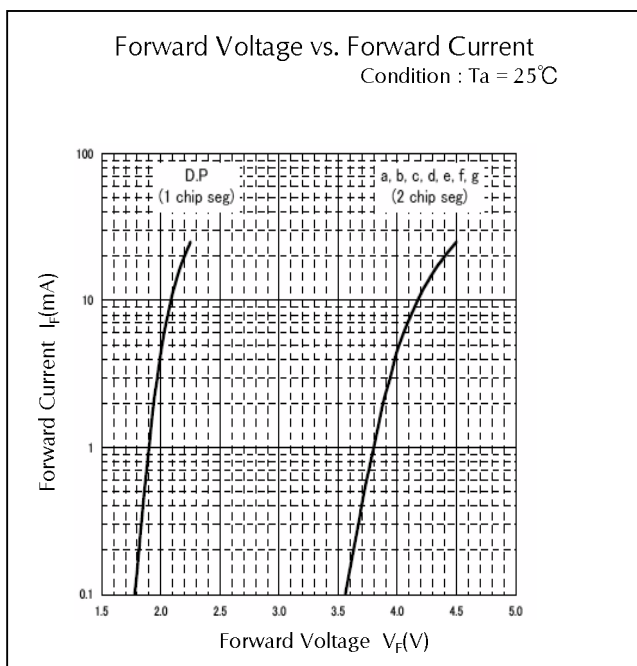

Technical Data(Green)

Ambient Temperature vs. Maximum Forward Current

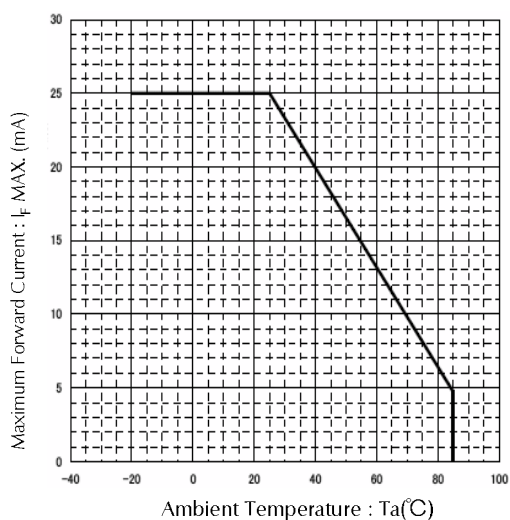

Ambient Temperature vs. Power Dissipation

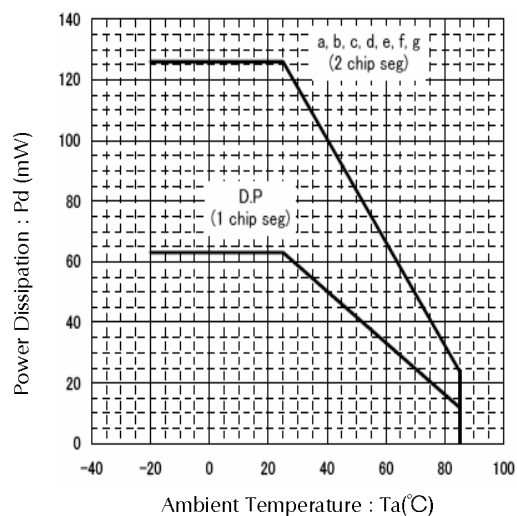

Duty Factor vs. Maximum Tolerable Pulse Forward Current
Condition : Ta = 25°C

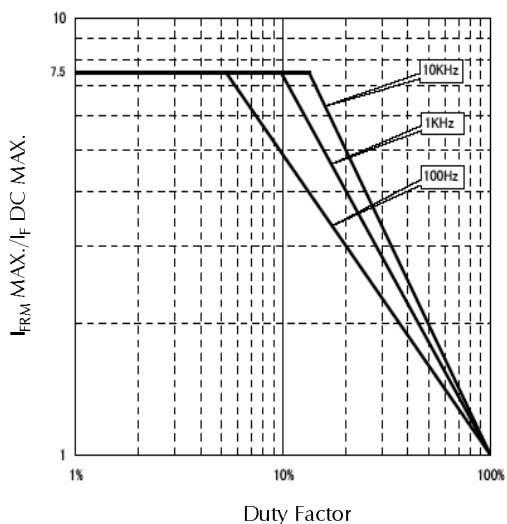

Technical Data(Orange)

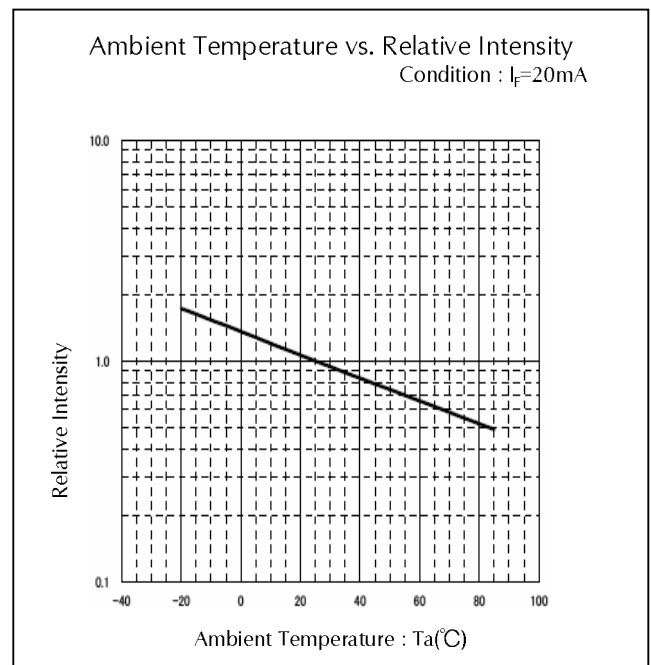
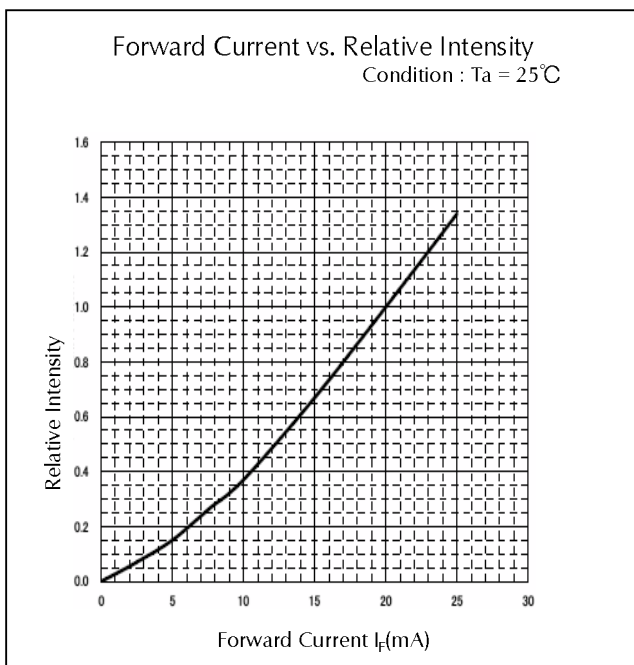
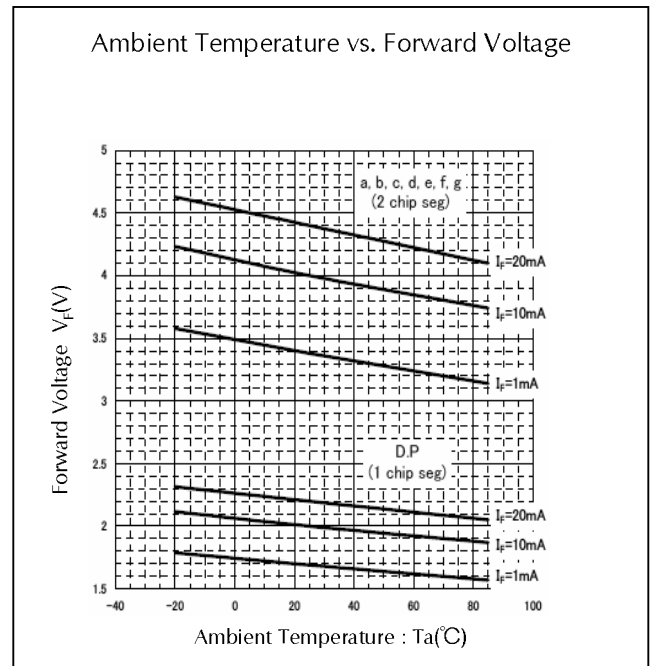
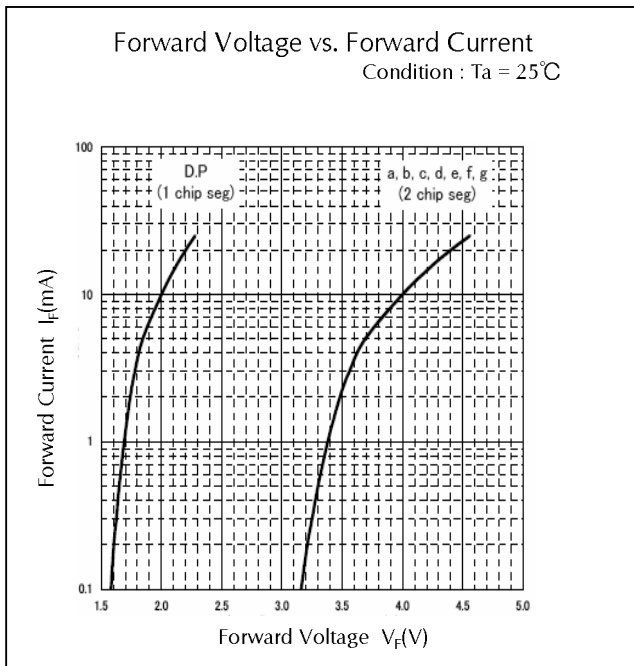

Technical Data(Orange)

Ambient Temperature vs. Maximum Forward Current

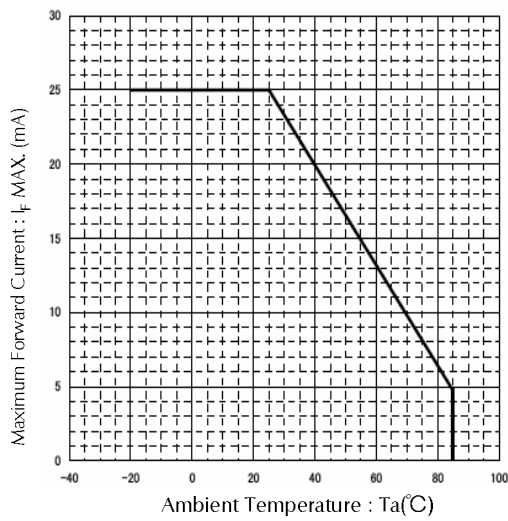

Ambient Temperature vs. Power Dissipation

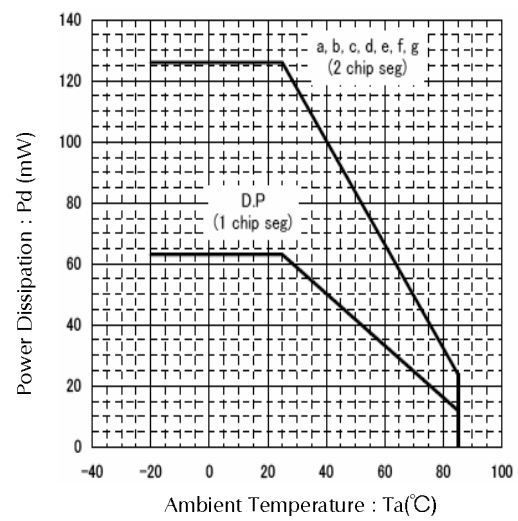

Duty Factor vs. Maximum Tolerable Pulse Forward Current
Condition : Ta = 25°C

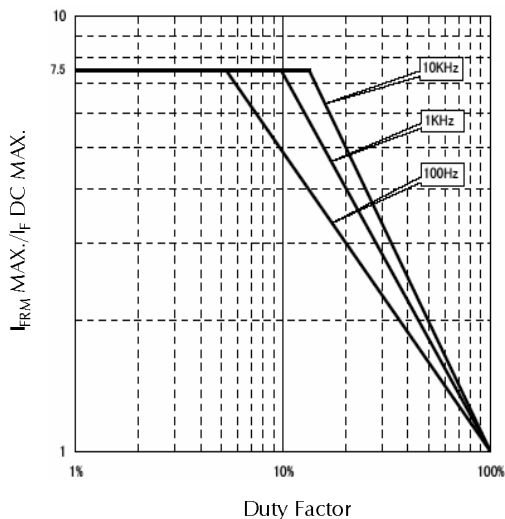

Technical Data(Red)

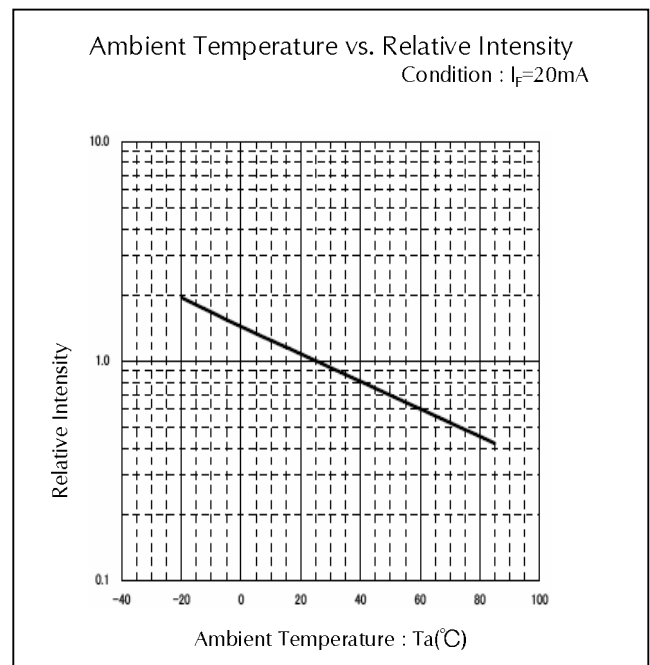
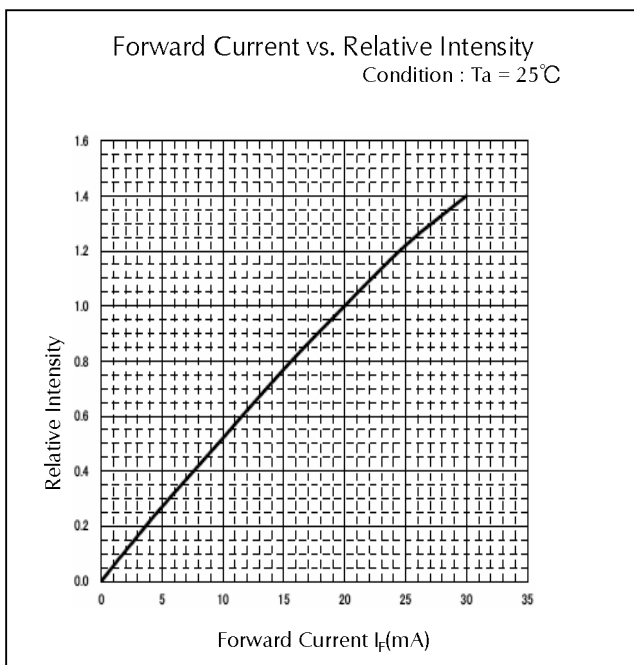
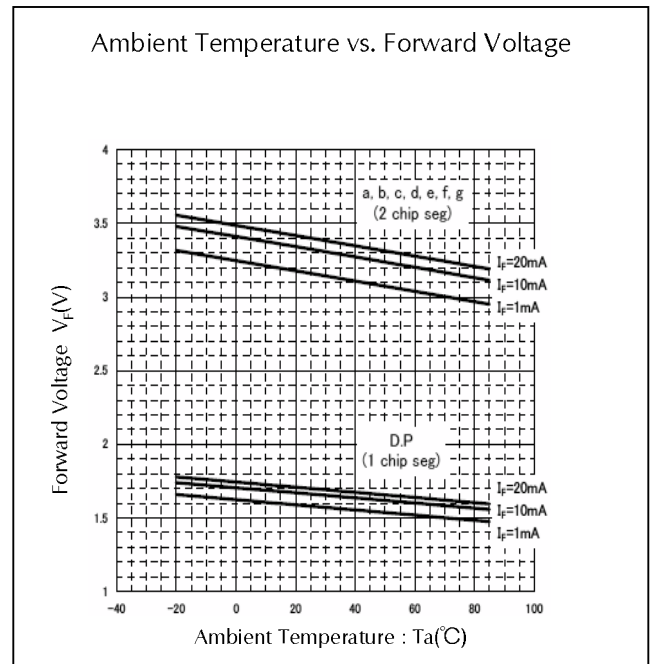
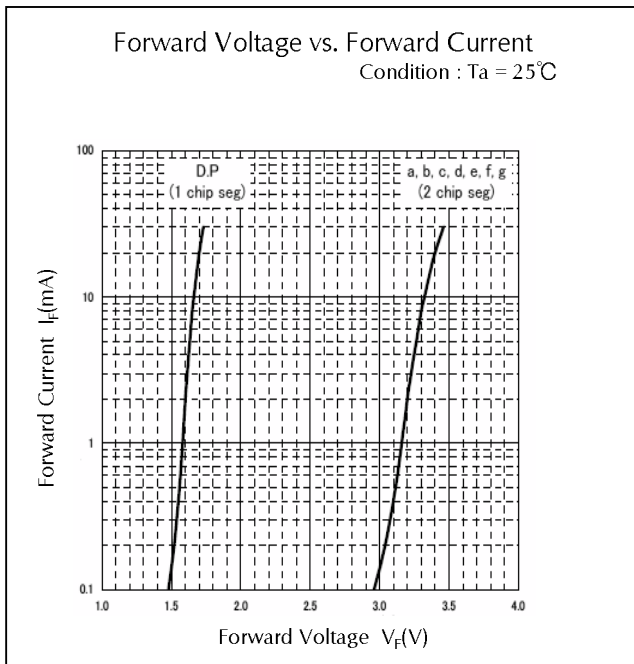

Technical Data(Red)

Ambient Temperature vs. Maximum Forward Current

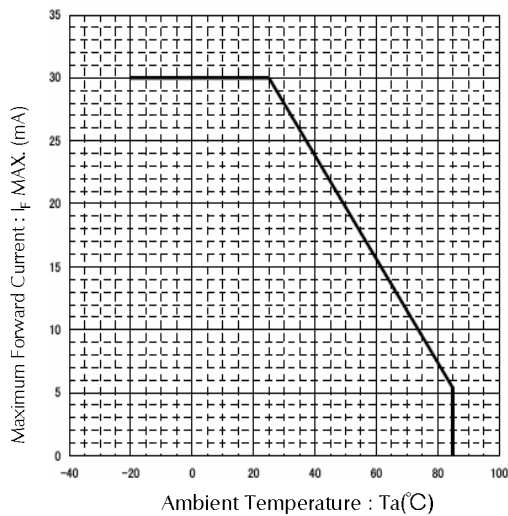

Ambient Temperature vs. Power Dissipation

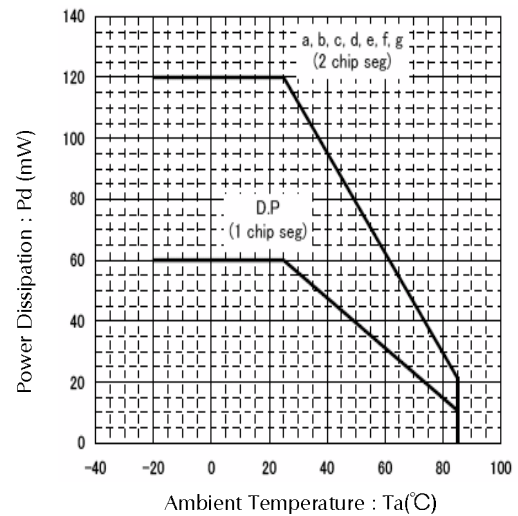

Duty Factor vs. Maximum Tolerable Pulse Forward Current
Condition : Ta = 25°C

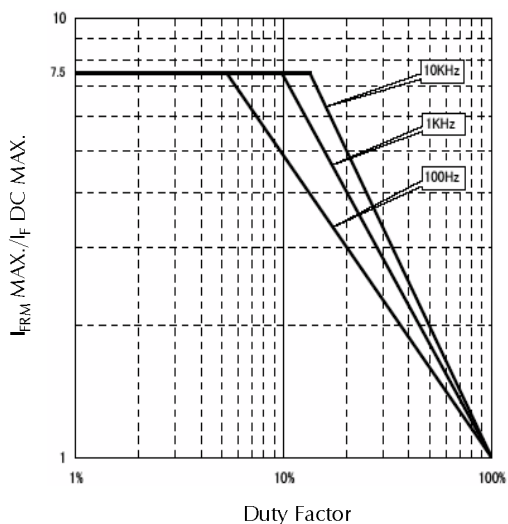

Package Dimensions

(Unit: mm)

(Tolerance : ± 0.25 mm)

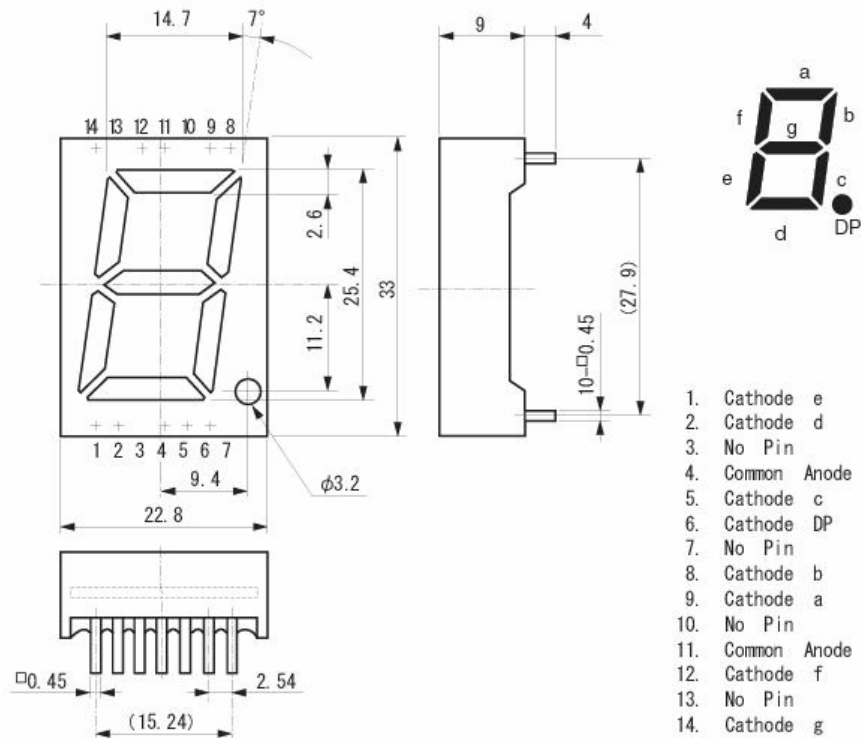

●Cathode common types have a reverse polarity.

TTW (Through The Wave) soldering Conditions

| | | |
|-------------------|--------------------------------------|--|
| Pre-heating | 100 °C 60 s | (MAX.) Resin surface temperature (MAX.) |
| Solder Bath Temp. | 265 °C | (MAX.) |
| Dipping Time | 5 s | (MAX.) |
| Position | At least 2.0 mm away from resin body | |

- 1) The dip soldering process shall be 2 times maximum.
- 2) The product shall be cooled to normal temperature before the second dipping process.

Manual Soldering Conditions

| | | |
|------------------------------|--------------------------------------|--------------------|
| Iron tip temp. | 400 °C | (MAX.) (30 W Max.) |
| Soldering time and frequency | 3 s 2 times | (MAX.) (MAX.) |
| Position | At least 2.0 mm away from resin body | |

Reliability Testing Result

| Reliability Testing Result | Applicable Standard | Testing Conditions | Duration | Failure |
|-------------------------------|-----------------------|---|----------|---------|
| Room Temp. Operating Life | EIAJ ED-4701/100(101) | Ta = 25°C, If = Maximum Rated Current/seg | 1,000 h | 0/10 |
| Resistance to Soldering Heat | EIAJ ED-4701/300(302) | 260±5°C, 3mm from package base | 10s | 0/10 |
| Temperature Cycling | EIAJ ED-4701/100(105) | Minimum Rated Storage Temperature(30min) ~Normal Temperature(15min) ~Maximum Rated Storage Temperature(30min) ~Normal Temperature(15min) | 5 cycles | 0/10 |
| Wet High Temp. Storage Life | EIAJ ED-4701/100(103) | Ta = 60±2°C, RH = 90±5% | 1,000 h | 0/10 |
| High Temp. Storage Life | EIAJ ED-4701/200(201) | Ta = Maximum Rated Storage Temperature | 1,000 h | 0/10 |
| Low Temp. Storage Life | EIAJ ED-4701/200(202) | Ta = Minimum Rated Storage Temperature | 1,000 h | 0/10 |
| Lead Tension | EIAJ ED-4701/400(401) | 5N, 1time | 10s | 0/10 |
| Vibration, Variable Frequency | EIAJ ED-4701/400(403) | 98.1m/s ² (10G), 100 ~ 2KHz sweep for 20min., XYZ each direction | 2 h | 0/10 |
| Lead Bend | EIAJ ED-4701/400(401) | 2.5N, 0° ↔ 90° | 2 times | 0/10 |
| Shock | JIS C 7201 A-8 | It falls on wood engraving from height of 75cm. | 3 times | 0/10 |

Failure Criteria

| Items | Symbols | Conditions | Failure criteria |
|---------------------|----------------|--|--|
| Luminous Intensity | Iv | If Value of each product Luminous Intensity | Testing Min. Value < Spec. Min. Value x 0.5 |
| Forward Voltage | V _F | If Value of each product Forward Voltage | Testing Max. Value ≥ Spec. Max. Value x 1.2 |
| Reverse Current | I _R | V _R = Maximum Rated Reverse Voltage V | Testing Max. Value ≥ Spec. Max. Value x 2.5 |
| Cosmetic Appearance | - | - | No notable, decoloration, deformation and cracking |

Special Notice to Customers Using the Products and Technical Information Shown in This Data Sheet

- 1) The technical information shown in the data sheets are limited to the typical characteristics and circuit examples of the referenced products. It does not constitute the warranting of industrial property nor the granting of any license.
- 2) For the purpose of product improvement, the specifications, characteristics and technical data described in the data sheets are subject to change without prior notice. Therefore it is recommended that the most updated specifications be used in your design.
- 3) When using the products described in the data sheets, please adhere to the maximum ratings for operating voltage, heat dissipation characteristics, and other precautions for use. We are not responsible for any damage which may occur if these specifications are exceeded.
- 4) The products described in the data sheets are made to be used in standard electronic applications such as office automation appliances, communication devices, audio visual, home appliances, and measuring instruments.
- 5) If the products in the data sheets are to be used for purposes other than the above which requires high level reliability and safety where failure and or malfunction of the product may cause death or other serious effects on the human body such as airplane, space activity, transportation, medical, nuclear), please contact our sales personnel.
- 6) In order to export the products or technologies described in this data sheet which are under the "Foreign Exchange and Foreign Trade Control Law," it is necessary to first obtain an export permit from the Japanese government.
- 7) No part of this data sheet may be reprinted or reproduced without prior written permission from Stanley Electric Co., Ltd.
- 8) The most updated edition of this data sheet can be obtained from the address below:
<http://www.stanley-components.com>