FEATURES

- complete linear system
- current mode class H output stage
- current drive power amp
- low distortion / low noise
- low amplifier current 190 μ A typical

STANDARD PACKAGING

- Hybrid Typical Dimensions
0.225in x 0.130in x 0.110in
(5.72mm x 3.31mm x 2.79mm)

DESCRIPTION

The GS3013 is a linear hybrid containing three amplifier stages.

This product incorporates a current mode class H power amplifier.

By adapting the bias of the output stage to the requirements of the signal being processed, significant current savings can be realised compared to traditional class A amplifiers.

The adaptive action does not compromise the characteristics of a current drive output stage.

In addition to the output stage, two additional stages of preamplification are provided to allow filtering and gain adjustment to be easily accomplished.

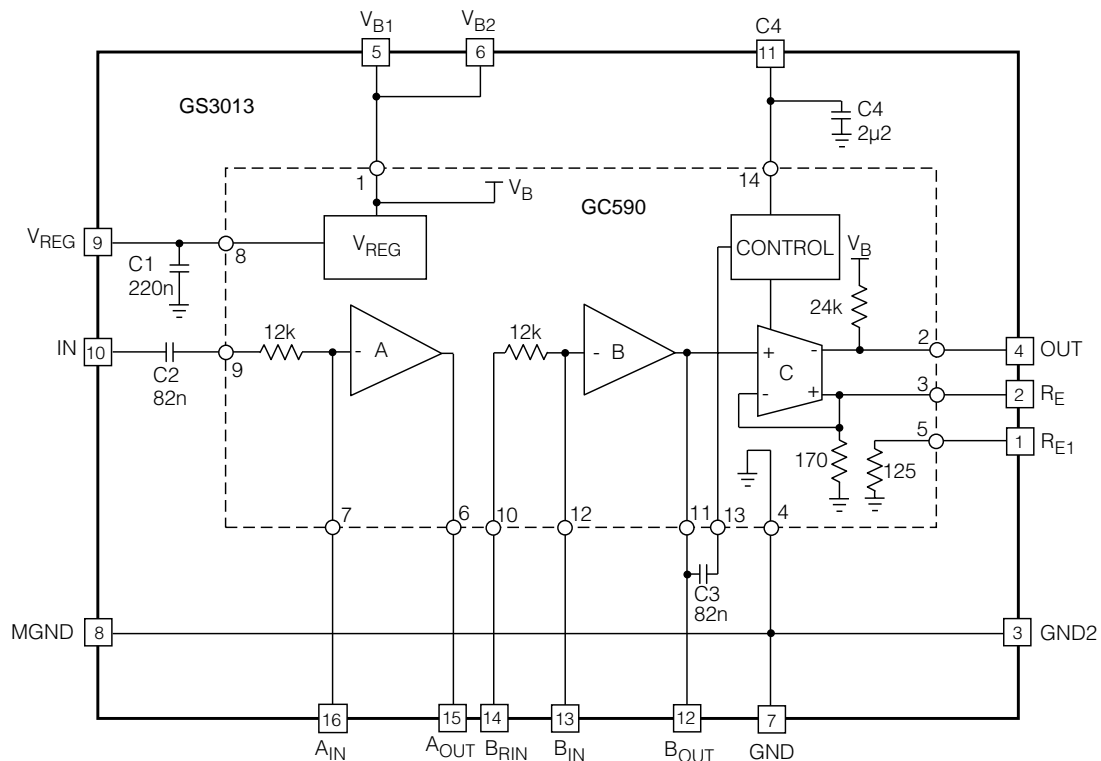

All resistors in ohms, all capacitors
in farads unless otherwise stated.

FUNCTIONAL BLOCK DIAGRAM

ABSOLUTE MAXIMUM RATINGS

PARAMETER	VALUE / UNITS
Supply Voltage	5 VDC
Power Dissipation	25 mW
Operating Temperature Range	-10° C to 40° C
Storage Temperature Range	-20° C to 70° C

CAUTION
CLASS 1 ESD SENSITIVITY



PAD CONNECTION

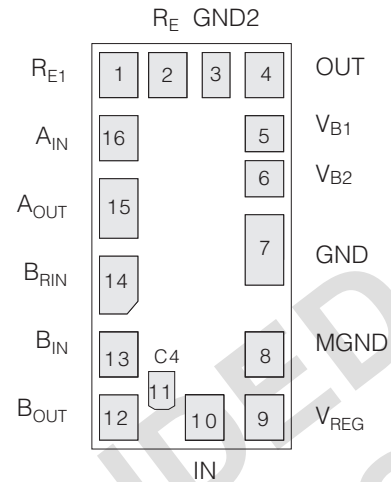

ELECTRICAL CHARACTERISTICS

Conditions: Frequency = 1 kHz, Temperature 25 °C, Voltage Supply = 1.3 VDC

PARAMETER	SYMBOL	CONDITIONS	MIN	TYP	MAX	UNITS
OVERALL						
Amplifier Current	I_{AMP}		80	190	300	μA
Minimum Operating Voltage	V_B		-	-	1.1	V
Overall Gain	A_V		51	54	57	dB
Distortion	THD	$V_{IN} = -40$ dBV $R_{TRIM} = R_{VC} = 10$ k Ω	-	0.2	1	%
Input Referred Noise	IRN	A Weighted Filter	-	-	2.5	μV_{RMS}
VOLTAGE REGULATOR						
Regulator Voltage	V_{REG}	$I_{LOAD} = 30$ μA	870	920	970	mVDC
Output Noise		A Weighted	-	2.9	-	μV_{RMS}
STAGE A AND STAGE B						
Input Bias Current	I_{BIAS}		-25	0	25	nA
DC Voltage Gain Stage A	A_{OL-A}		-	52	-	dB
DC Voltage Gain Stage B	A_{OL-B}		-	42	-	dB
Current Source Capabilities	I_{SOURCE}		15	30	-	μA
Output Voltage Swing - Low	V_{SINK}		260	315	-	mV
STAGE C AND CONTROL CIRCUIT						
Maximum Current Sinking	I_{SINK}	R_E grounded, $V_{P4} = 1.3$ V	3	6	-	mA
Output Impedance	R_{OUT}		-	24	-	k Ω
Minimum Emitter Voltage	V_{RE-MIN}		2	5	9	mV
Maximum Emitter Voltage	V_{RE-MAX}		62	66	74	mV
Minimum Transducer Current	I_{T-MIN}	R_E, R_{E1} shorted	26	71	126	μA
Maximum Transducer Current	I_{T-MAX}	R_E, R_{E1} shorted	750	930	1100	μA
Maximum/Minimum Transducer Current Ratio	I_{RANGE}		16	20	28	dB
Dynamic Headroom	Headroom	Note 1	14	17	22	dB
Time Constant	T_C		-	100	-	mS

All parameters and switches remain as shown in the Test Circuit unless otherwise stated in CONDITIONS column.

Notes: 1. Headroom = $20 \text{ Log} (V_{RE-DC} / V_{RE-ACRMS})$ [$V_{IN} = -70$ dBV]

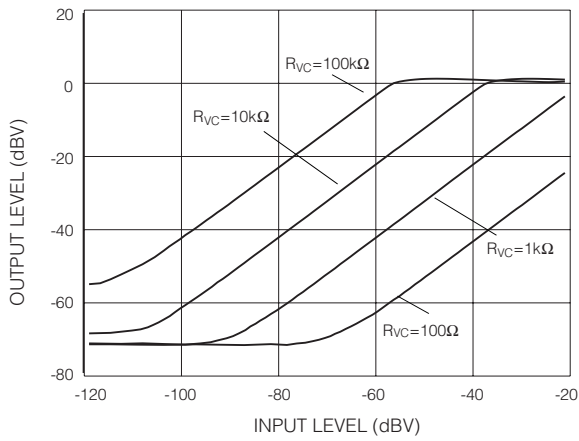

Fig. 5 Input vs Output Transfer Function for the Different Values of the R_{VC} Resistor

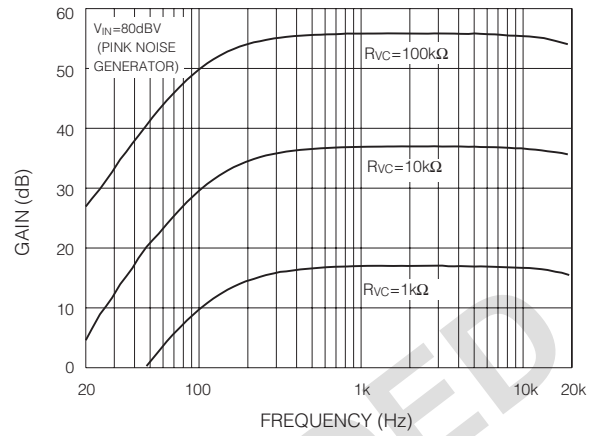

Fig. 6 Frequency Response for Different R_{VC} Values

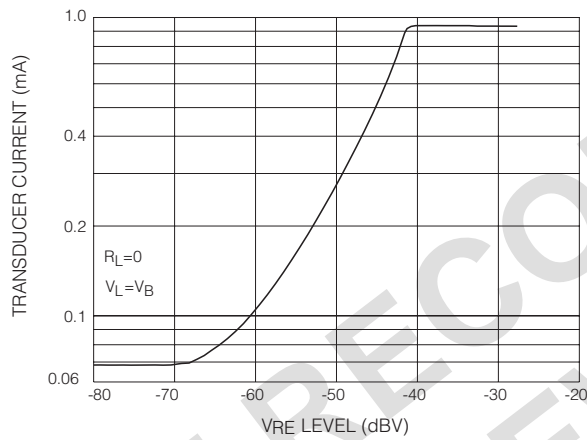

Fig. 7 Transducer Current Characteristics

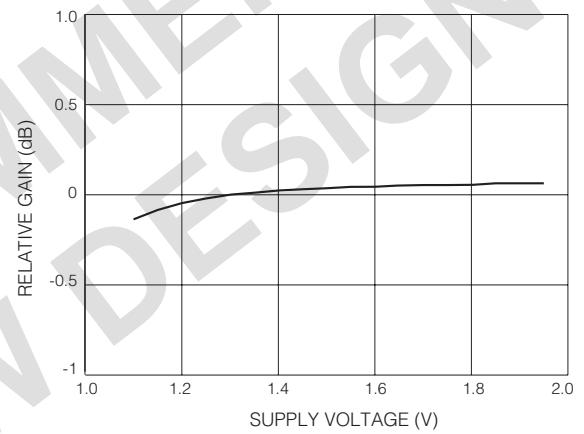

Fig. 8 System Gain vs Supply

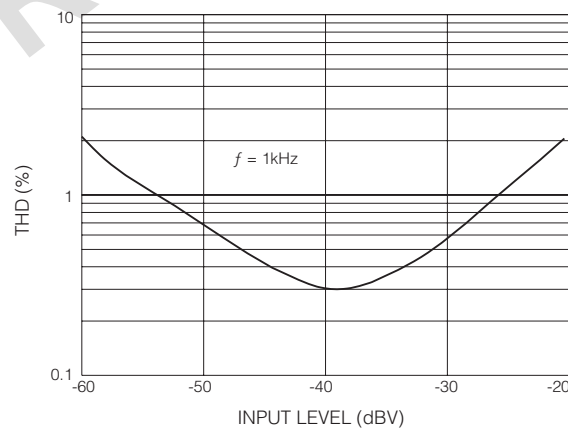

Fig. 9 THD & Noise vs Input Level

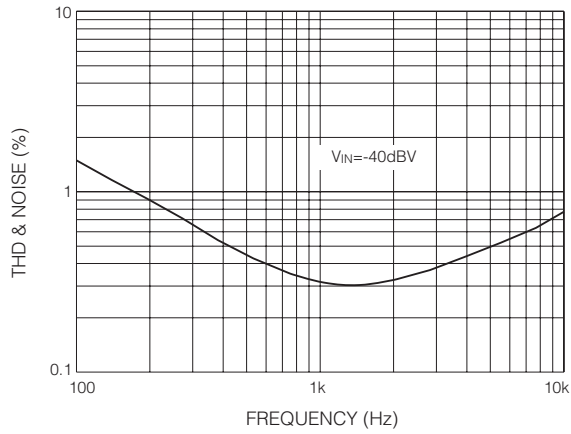

Fig. 10 THD & Noise vs Frequency

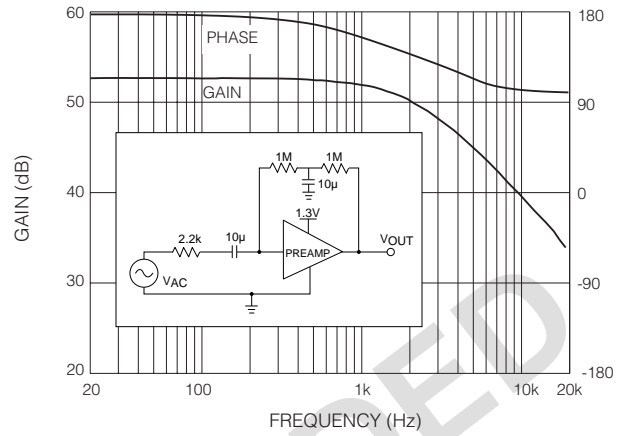

Fig. 11 Stage A Open Loop Gain & Phase vs Frequency

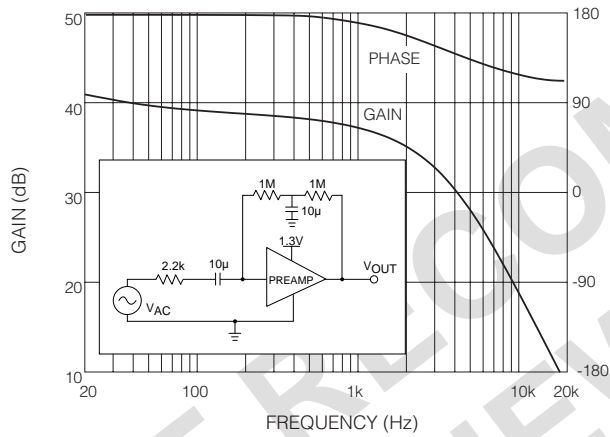

Fig. 12 Stage B Open Loop Gain & Phase vs Frequency

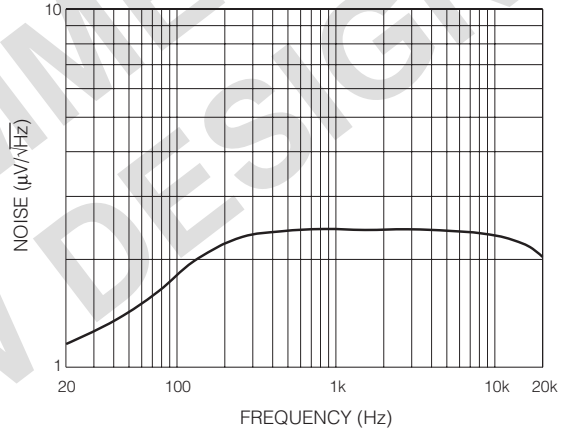

Fig. 13 Output Noise vs Frequency

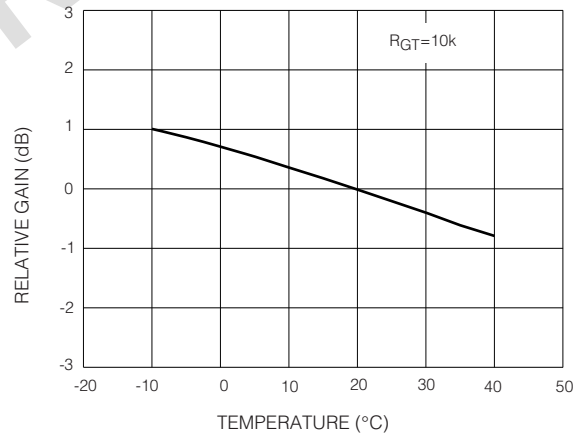
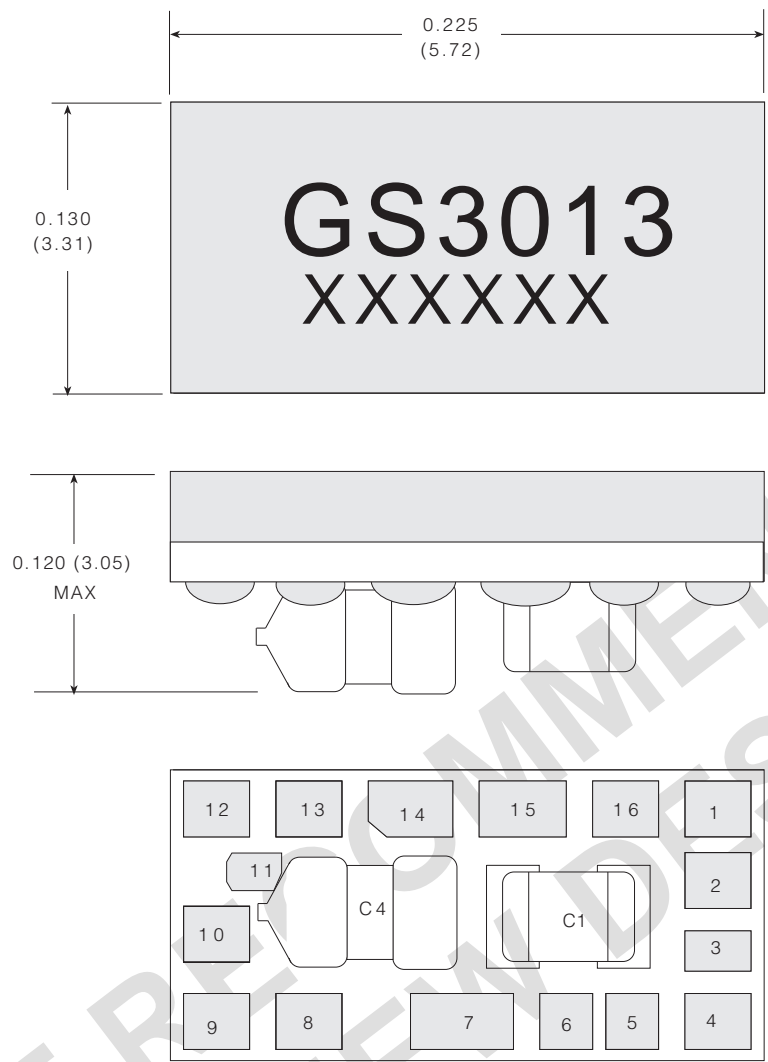

Fig. 14 Relative Gain vs Temperature



Dimension units are in inches.
 Dimensions in parenthesis are in millimetres converted from inches and include minor rounding errors.
 1.0000 inches = 25.400 mm.
 Smallest pad no.3 0.025 x 0.018 (0.63 x 0.46).
 Largest pad no.7 0.039 x 0.025 (0.99 x 0.64).
 Dimension tolerances: ± 0.005 (+0.13) unless otherwise stated.
 Pad numbers and capacitor numbers for illustration only.
 XXXXXX - work order number.
 This hybrid is designed for point to point manual soldering.

Fig. 8 Hybrid Layout & Dimensions

DOCUMENT IDENTIFICATION: DATA SHEET
 The product is in production. Gennum reserves the right to make changes at any time to improve reliability, function or design, in order to provide the best product possible.

REVISION NOTES:
 Updated to Data sheet