

# HiPerFAST™ IGBT

**IXGH 30N60C2**  
**IXGT 30N60C2**

**C2-Class High Speed IGBTs**

$V_{CES} = 600 \text{ V}$   
 $I_{C25} = 70 \text{ A}$   
 $V_{CE(sat)} = 2.7 \text{ V}$   
 $t_{fi\text{typ}} = 32 \text{ ns}$

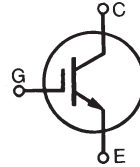

| Symbol  | Test Conditions   | Maximum Ratings  |                  |
|---|---|------------------|------------------|
| $V_{CES}$   | $T_J = 25^\circ\text{C}$ to $150^\circ\text{C}$   | 600              | V                |
| $V_{CGR}$   | $T_J = 25^\circ\text{C}$ to $150^\circ\text{C}$ ; $R_{GE} = 1 \text{ M}\Omega$  | 600              | V                |
| $V_{GES}$   | Continuous  | $\pm 20$         | V                |
| $V_{GEM}$   | Transient   | $\pm 30$         | V                |
| $I_{C25}$   | $T_C = 25^\circ\text{C}$ (limited by leads)   | 70               | A                |
| $I_{C110}$  | $T_C = 110^\circ\text{C}$   | 30               | A                |
| $I_{CM}$  | $T_C = 25^\circ\text{C}$ , 1 ms   | 150              | A                |
| <b>SSOA</b><br><b>(RBSOA)</b>   | $V_{GE} = 15 \text{ V}$ , $T_{VJ} = 125^\circ\text{C}$ , $R_G = 10 \Omega$<br>Clamped inductive load @ $\leq 600 \text{ V}$ | $I_{CM} = 60$    | A                |
| $P_C$   | $T_C = 25^\circ\text{C}$  | 190              | W                |
| $T_J$   |   | -55 ... +150     | $^\circ\text{C}$ |
| $T_{JM}$  |   | 150              | $^\circ\text{C}$ |
| $T_{stg}$   |   | -55 ... +150     | $^\circ\text{C}$ |
| Maximum lead temperature for soldering<br>1.6 mm (0.062 in.) from case for 10 s |   | 300              | $^\circ\text{C}$ |
| Plastic body for 10s  |   | 250              | $^\circ\text{C}$ |
| $M_d$   | Mounting torque (M3) (TO-247)   | 1.13/10Nm/lb.in. |                  |
| <b>Weight</b>   | TO-247  | 6                | g                |
|   | TO-268  | 4                | g                |

**TO-268 (IXGT)**

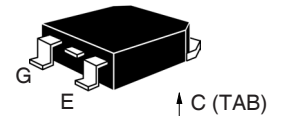

**TO-247 (IXGH)**

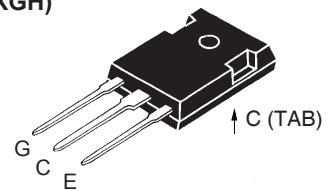

G = Gate, C = Collector,  
E = Emitter, TAB = Collector

### Features

- Very high frequency IGBT
- Square RBSOA
- High current handling capability
- MOS Gate turn-on - drive simplicity

### Applications

- PFC circuits
- Uninterruptible power supplies (UPS)
- Switched-mode and resonant-mode power supplies
- AC motor speed control
- DC servo and robot drives
- DC choppers

| Symbol        | Test Conditions                                      | Characteristic Values<br>( $T_J = 25^\circ\text{C}$ , unless otherwise specified) |      |                          |
|---------------|--|---|------|--------------------------|
|               |  | min.  | typ. | max.                     |
| $V_{GE(th)}$  | $I_C = 250 \mu\text{A}$ , $V_{CE} = V_{GE}$          | 2.5   |      | 5.0 V                    |
| $I_{CES}$     | $V_{CE} = V_{CES}$<br>$V_{GE} = 0 \text{ V}$         |   |      | 50 $\mu\text{A}$<br>1 mA |
| $I_{GES}$     | $V_{CE} = 0 \text{ V}$ , $V_{GE} = \pm 20 \text{ V}$ |   |      | $\pm 100 \text{ nA}$     |
| $V_{CE(sat)}$ | $I_C = 24 \text{ A}$ , $V_{GE} = 15 \text{ V}$       |   | 2.0  | 2.7 V<br>V               |

| Symbol   | Test Conditions  | Characteristic Values<br>( $T_J = 25^\circ\text{C}$ , unless otherwise specified) |      |                  |    |
|--|--|---|------|------------------|----|
|  |  | min.  | typ. | max.             |    |
| $g_{fs}$   | $I_C = 24\text{ A}; V_{CE} = 10\text{ V}$ ,<br>Pulse test, $t \leq 300\ \mu\text{s}$ , duty cycle $\leq 2\%$   | 18  | 28   | S                |    |
| $C_{ies}$<br>$C_{oes}$<br>$C_{res}$  | $V_{CE} = 25\text{ V}, V_{GE} = 0\text{ V}, f = 1\text{ MHz}$  |   | 1430 | pF               |    |
|  |  |   | 110  | pF               |    |
|  |  |   | 40   | pF               |    |
| $Q_g$<br>$Q_{ge}$<br>$Q_{gc}$  | $I_C = 24\text{ A}, V_{GE} = 15\text{ V}, V_{CE} = 300\text{ V}$   |   | 70   | nC               |    |
|  |  |   | 10   | nC               |    |
|  |  |   | 23   | nC               |    |
| $t_{d(on)}$<br>$t_{ri}$<br>$t_{d(off)}$<br>$t_{fi}$<br>$E_{off}$             | <b>Inductive load, <math>T_J = 25^\circ\text{C}</math></b><br>$I_C = 24\text{ A}, V_{GE} = 15\text{ V}$<br>$V_{CE} = 400\text{ V}, R_G = 5\ \Omega$  |   | 13   | ns               |    |
|  |  |   | 15   | ns               |    |
|  |  |   | 70   | 140              | ns |
|  |  |   | 60   | ns               |    |
|  |  |   | 0.29 | 0.30             | mJ |
| $t_{d(on)}$<br>$t_{ri}$<br>$E_{on}$<br>$t_{d(off)}$<br>$t_{fi}$<br>$E_{off}$ | <b>Inductive load, <math>T_J = 125^\circ\text{C}</math></b><br>$I_C = 24\text{ A}, V_{GE} = 15\text{ V}$<br>$V_{CE} = 400\text{ V}, R_G = 5\ \Omega$ |   | 13   | ns               |    |
|  |  |   | 17   | ns               |    |
|  |  |   | 0.22 | mJ               |    |
|  |  |   | 120  | ns               |    |
|  |  |   | 130  | ns               |    |
|  |  |   | 0.59 | mJ               |    |
| $R_{thJC}$<br>$R_{thCK}$   | (TO-247)   |   |      | 0.65<br>KW<br>KW |    |

### Min. Recommended Footprint (Dimensions in inches and mm)

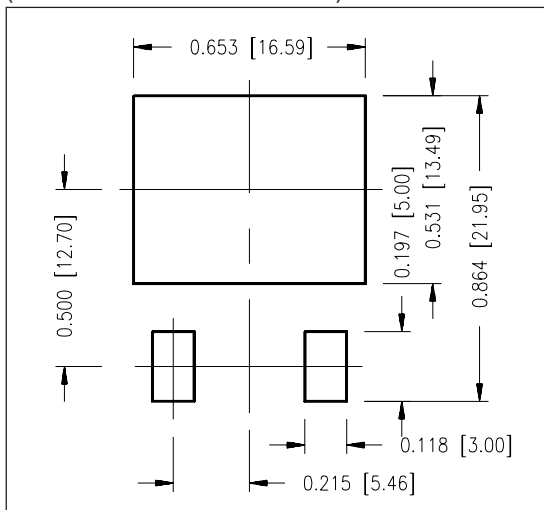

### TO-247 AD Outline

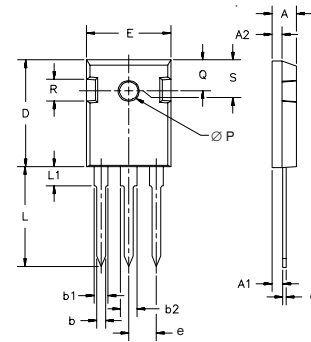

| Dim.           | Millimeter |       | Inches |       |
|----------------|------------|-------|--------|-------|
|                | Min.       | Max.  | Min.   | Max.  |
| A              | 4.7        | 5.3   | .185   | .209  |
| A <sub>1</sub> | 2.2        | 2.54  | .087   | .102  |
| A <sub>2</sub> | 2.2        | 2.6   | .059   | .098  |
| b              | 1.0        | 1.4   | .040   | .055  |
| b <sub>1</sub> | 1.65       | 2.13  | .065   | .084  |
| b <sub>2</sub> | 2.87       | 3.12  | .113   | .123  |
| C              | .4         | .8    | .016   | .031  |
| D              | 20.80      | 21.46 | .819   | .845  |
| E              | 15.75      | 16.26 | .610   | .640  |
| e              | 5.20       | 5.72  | 0.205  | 0.225 |
| L              | 19.81      | 20.32 | .780   | .800  |
| L <sub>1</sub> |            | 4.50  |        | .177  |
| ∅P             | 3.55       | 3.65  | .140   | .144  |
| Q              | 5.89       | 6.40  | 0.232  | 0.252 |
| R              | 4.32       | 5.49  | .170   | .216  |
| S              | 6.15       | BSC   | .242   | BSC   |

### TO-268 Outline

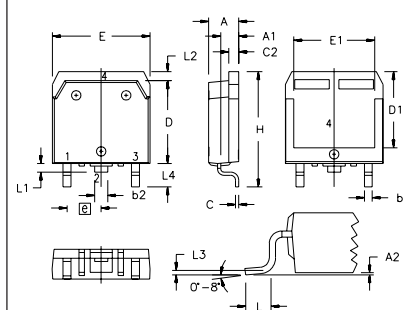

| SYM            | INCHES   |      | MILLIMETERS |       |
|----------------|----------|------|-------------|-------|
|                | MIN      | MAX  | MIN         | MAX   |
| A              | .193     | .201 | 4.90        | 5.10  |
| A <sub>1</sub> | .106     | .114 | 2.70        | 2.90  |
| A <sub>2</sub> | .001     | .010 | 0.02        | 0.25  |
| b              | .045     | .057 | 1.15        | 1.45  |
| b <sub>2</sub> | .075     | .083 | 1.90        | 2.10  |
| C              | .016     | .026 | 0.40        | 0.65  |
| C <sub>2</sub> | .057     | .063 | 1.45        | 1.60  |
| D              | .543     | .551 | 13.80       | 14.00 |
| D <sub>1</sub> | .488     | .500 | 12.40       | 12.70 |
| E              | .624     | .632 | 15.85       | 16.05 |
| E <sub>1</sub> | .524     | .535 | 13.30       | 13.60 |
| e              | .215 BSC |      | 5.45 BSC    |       |
| H              | .736     | .752 | 18.70       | 19.10 |
| L              | .094     | .106 | 2.40        | 2.70  |
| L <sub>1</sub> | .047     | .055 | 1.20        | 1.40  |
| L <sub>2</sub> | .039     | .045 | 1.00        | 1.15  |
| L <sub>3</sub> | .010 BSC |      | 0.25 BSC    |       |
| L <sub>4</sub> | .150     | .161 | 3.80        | 4.10  |

IXYS reserves the right to change limits, test conditions, and dimensions.

|  |           |           |           |           |              |              |              |              |
|--|-----------|-----------|-----------|-----------|--------------|--------------|--------------|--------------|
| IXYS MOSFETs and IGBTs are covered by one or more of the following U.S. patents: | 4,835,592 | 4,931,844 | 5,049,961 | 5,237,481 | 6,162,665    | 6,404,065 B1 | 6,683,344    | 6,727,585    |
|  | 4,850,072 | 5,017,508 | 5,063,307 | 5,381,025 | 6,259,123 B1 | 6,534,343    | 6,710,405 B2 | 6,759,692    |
|  | 4,881,106 | 5,034,796 | 5,187,117 | 5,486,715 | 6,306,728 B1 | 6,583,505    | 6,710,463    | 6,771,478 B2 |

**Fig. 1. Output Characteristics  
@ 25 Deg. C**

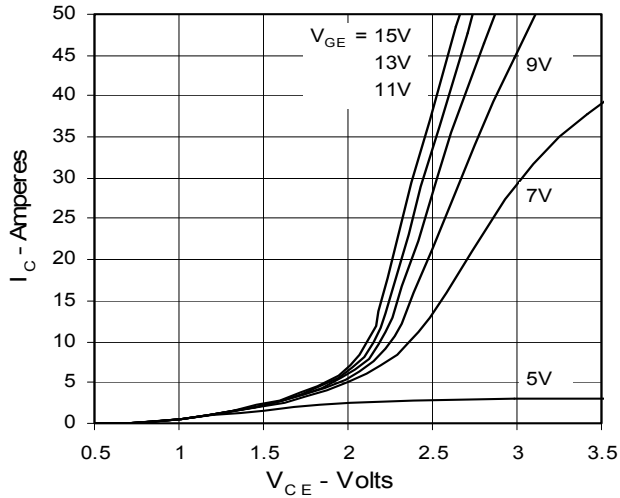

**Fig. 2. Extended Output Characteristics  
@ 25 deg. C**

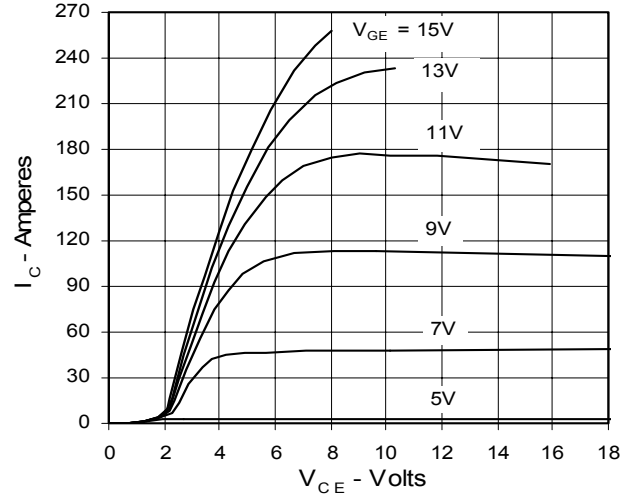

**Fig. 3. Output Characteristics  
@ 125 Deg. C**

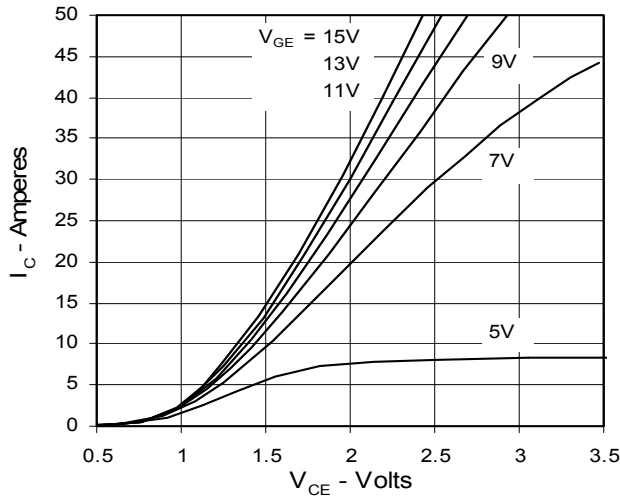

**Fig. 4. Dependence of  $V_{CE(sat)}$  on  
Temperature**

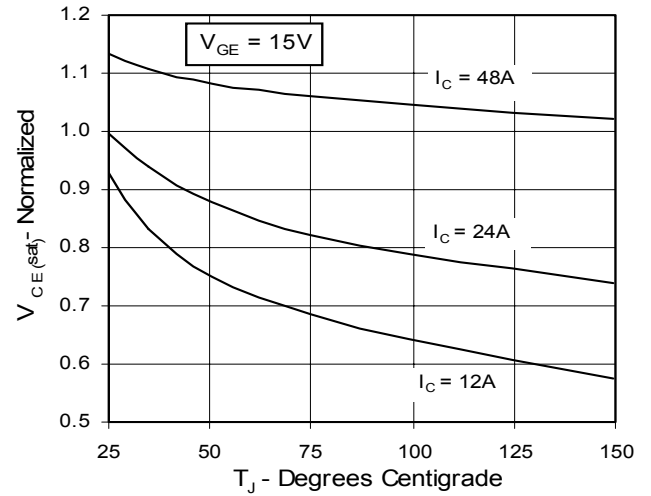

**Fig. 5. Collector-to-Emitter Voltage  
vs. Gate-to-Emitter voltage**

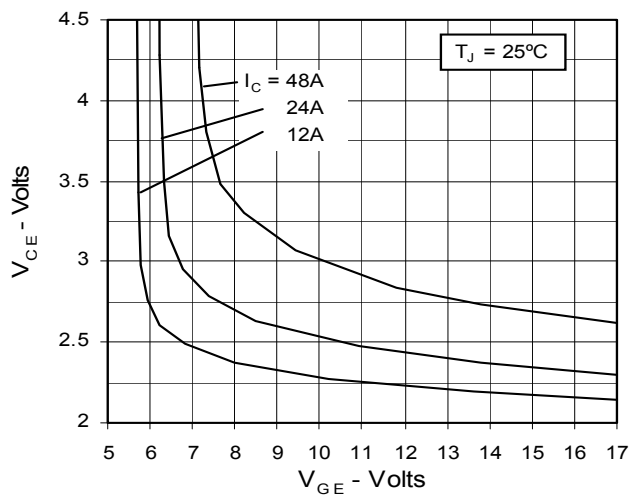

**Fig. 6. Input Admittance**

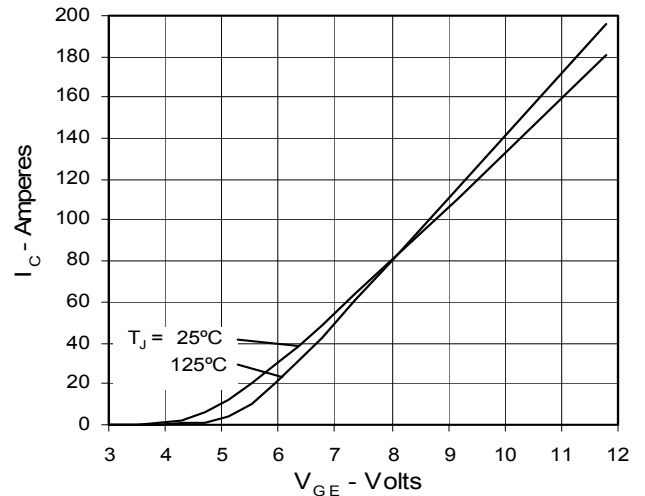

**Fig. 7. Transconductance**

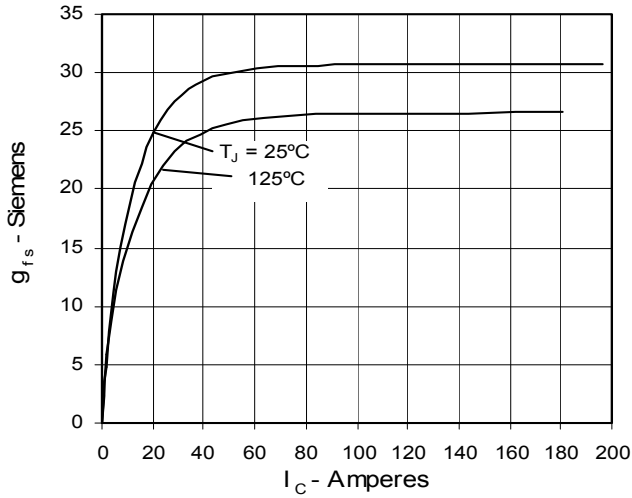

**Fig. 8. Dependence of Turn-Off Energy on  $R_G$**

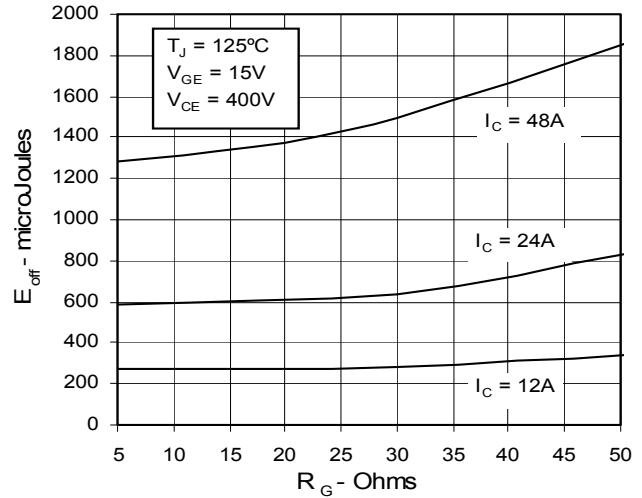

**Fig. 9. Dependence of Turn-Off Energy on  $I_C$**

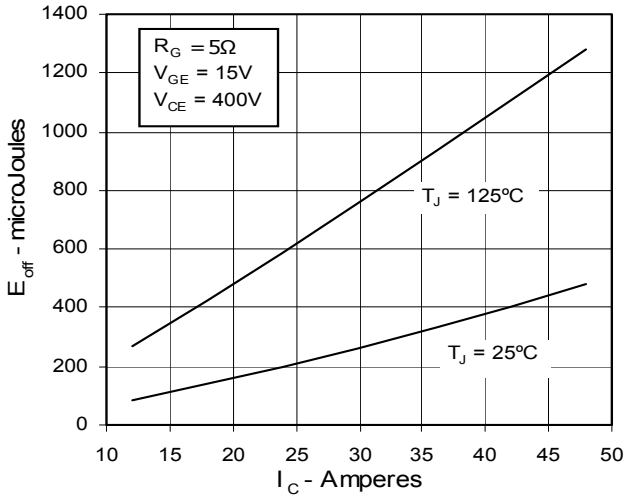

**Fig. 10. Dependence of Turn-Off Energy on Temperature**

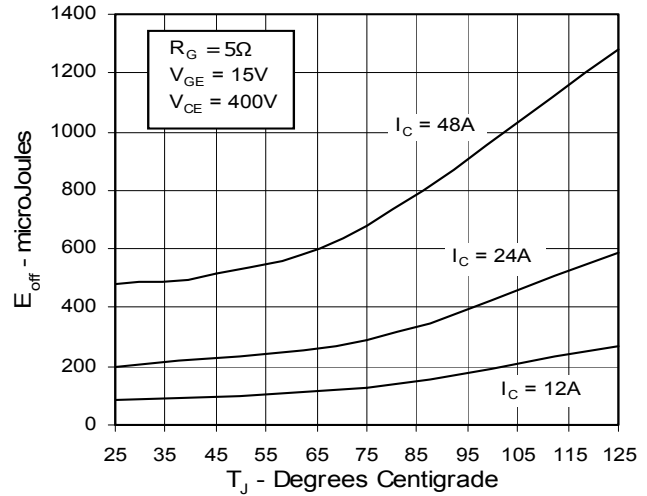

**Fig. 11. Dependence of Turn-Off Switching Time on  $R_G$**

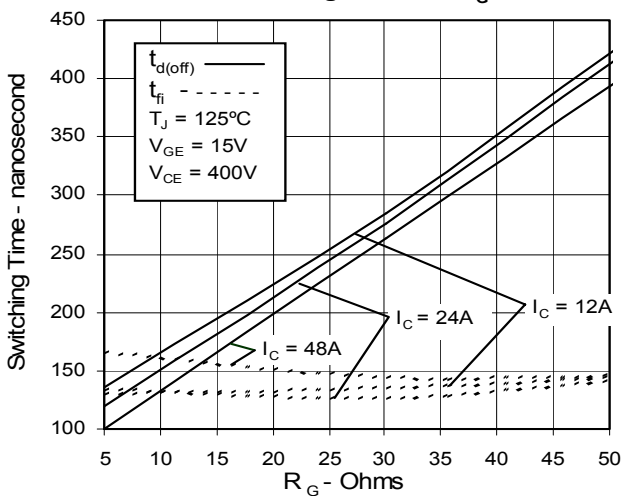

**Fig. 12. Dependence of Turn-Off Switching Time on  $I_C$**

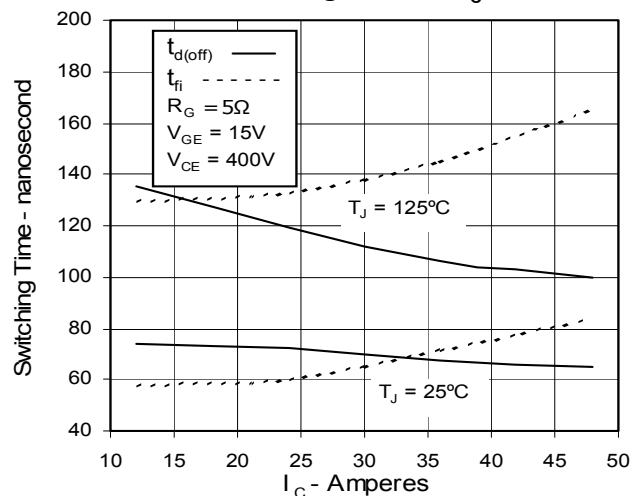

**Fig. 13. Dependence of Turn-Off Switching Time on Temperature**

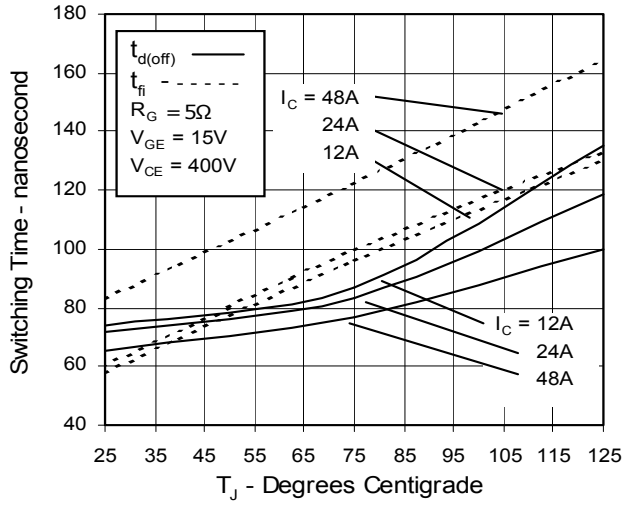

**Fig. 14. Gate Charge**

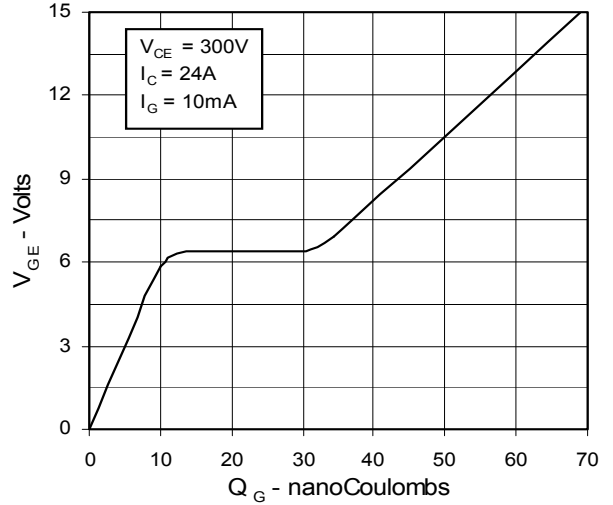

**Fig. 15. Capacitance**

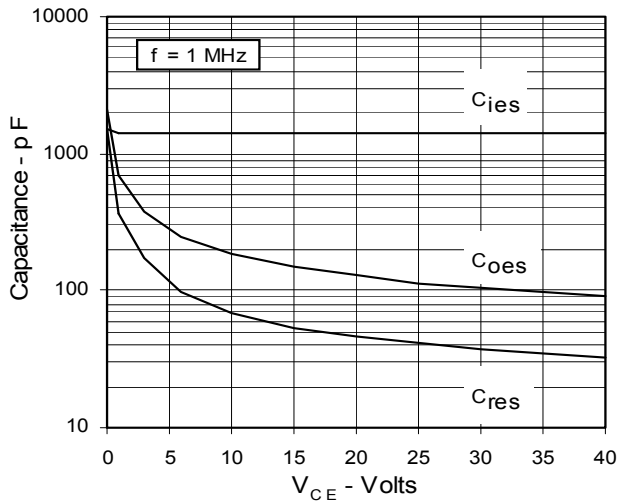

**Fig. 16. Maximum Transient Thermal Resistance**

