

## Electroluminescent Lamp Driver Low Power Applications

- 2.2V-5.0V Battery Operation
- 50nA Maximum Standby Current
- High Voltage Output 160 V<sub>pp</sub> typical
- Internal Oscillator

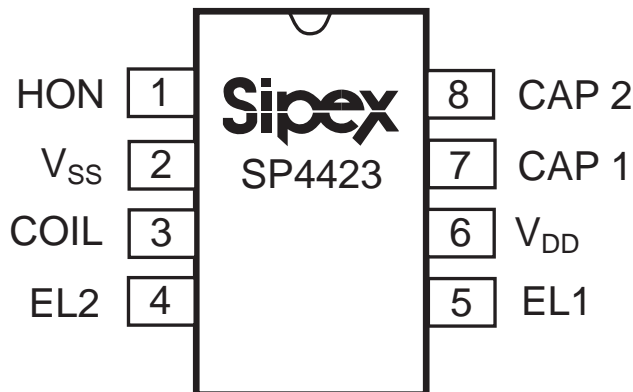
### APPLICATIONS

- PDAs
- Cellular Phones
- Remote Controls
- Hand Held Computers



### DESCRIPTION

The **SP4423** is a high voltage output DC-AC converter that can operate from a 2.2V-6.0V power supply. The **SP4423** is capable of supplying up to 200 V<sub>pp</sub> signals, making it ideal for driving electroluminescent lamps. The device features 10nA (typical) standby current, for use in low power portable products. An inductor is used to generate the high voltage, and an external capacitor is used to select the oscillator frequency. The **SP4423** is offered in an 8-pin narrow SOIC and 8-pin  $\mu$ SOIC packages. For delivery in die form, please consult the factory.



## ABSOLUTE MAXIMUM RATINGS

These are stress ratings only and functional operation of the device at these ratings or any other above those indicated in the operation sections of the specifications below is not implied. Exposure to absolute maximum rating conditions for extended periods of time may affect reliability.

V <sub>DD</sub> .....	7.0V
Input Voltages/Currents	
HON (pin1).....	-0.5V to (V <sub>DD</sub> +0.5V)
COIL (pin3).....	60mA
Lamp Outputs.....	230V <sub>pp</sub>
Storage Temperature.....	-65°C to +150°C

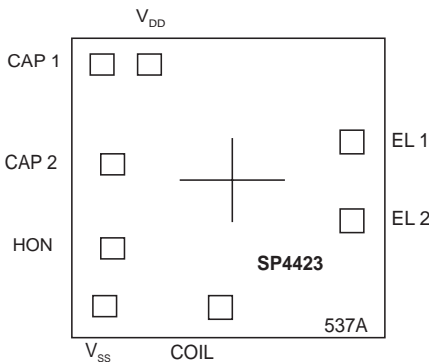
## SPECIFICATIONS

(T = 25°C; V<sub>DD</sub> = 3.0V; Lamp Capacitance = 6000pF; Coil = 20 mH (R<sub>s</sub> = 70Ω); C<sub>OSC</sub> = 150pF unless otherwise noted)

PARAMETER	MIN.	TYP.	MAX.	UNITS	CONDITIONS
Supply Voltage, V <sub>DD</sub>	2.2	3.0	6.0	V	
Supply Current, I <sub>COIL</sub> +I <sub>DD</sub>		5 12	12 40	mA	V <sub>DD</sub> =3.0V, V <sub>HON</sub> =3.0V V <sub>DD</sub> =6.0V, V <sub>HON</sub> =6.0V
Coil Voltage, V <sub>COIL</sub>	V <sub>DD</sub>		6.0	V	
HON Input Voltage, V <sub>HON</sub> LOW: EL off HIGH: EL on	-0.25 V <sub>DD</sub> -0.25	0 V <sub>DD</sub>	0.25V V <sub>DD</sub> +0.25	V	
HON Current, EL on		25 50	60 120	μA	V <sub>HON</sub> =V <sub>DD</sub> =3.0V V <sub>HON</sub> =V <sub>DD</sub> =6.0V
Shutdown Current, I <sub>SD</sub> =I <sub>COIL</sub> +I <sub>DD</sub>		10 0.3	200 1	nA μA	V <sub>DD</sub> =3.0V, V <sub>HON</sub> =0V V <sub>DD</sub> =6.0V, V <sub>HON</sub> =0V
<b>INDUCTOR DRIVE</b>					
Coil Frequency, f <sub>COIL</sub> =f <sub>LAMP</sub> ×32		9.6		kHz	
Coil Duty Cycle		75		%	
Peak Coil Current, I <sub>PK-COIL</sub>			60	mA	Guaranteed by design.
<b>EL LAMP OUTPUT</b>					
EL Lamp Frequency, f <sub>LAMP</sub>	200 225	300 300	400 450	Hz	V <sub>DD</sub> =3.0V V <sub>DD</sub> =6.0V
Peak to Peak Output Voltage	110	150		V <sub>pp</sub>	

This data sheet specifies environmental parameters, final test conditions and limits as well suggested operating conditions. For applications which require performance beyond the specified conditions and or limits please consult the factory.

## Bonding Diagram:



## Power Dissipation Per Package

8-pin NSOIC (derate 6.14mW/°C above +70°C).....	500mW
8-pin μSOIC (derate 4.85mW/°C above +70°C).....	390mW

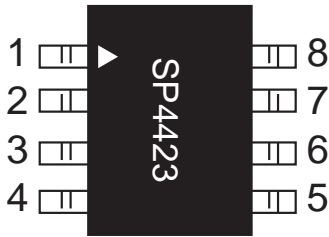
The information furnished herein by Sipex has been carefully reviewed for accuracy and reliability. Its application or use, however, is solely the responsibility of the user. No responsibility for the use of this information is assumed by Sipex, and this information shall not explicitly or implicitly become part of the terms and conditions of any subsequent sales agreement with Sipex. Specifications are subject to change without prior notice. By the sale or transfer of this information, Sipex assumes no responsibility for any infringement of patents or other rights of third parties which may result from its use. No license or other proprietary rights are granted by implication or otherwise under any patent or patent rights of Sipex Corporation.

PAD	X	Y
EL1	556.5	179.0
EL2	556.2	-151.0
COIL	-19.5	-517.0
V <sub>SS</sub>	-568.0	-517.0
HON	-549.0	-256.5
CAP2	-549.0	93.5
CAP1	-568.0	-516.5
V <sub>DD</sub>	-349.0	517.0

### NOTES:

1. Dimensions are in Microns unless otherwise noted.
2. Bonding pads are 125x125 typical
3. Outside dimensions are maximum, including scribe area.
4. Die thickness is 10 mils +/- 1.
5. Pad center coordinates are relative to die center.
6. Die size 1447 x 1346 ( 57 x 53 mils)

## PIN DESCRIPTION



Pin 1 – HON- Enable for driver operation, high = active; low = inactive.

Pin 2 –  $V_{SS}$ - Power supply common, connect to ground.

Pin 3 – Coil- Coil input, connect coil from  $V_{DD}$  to pin 3.

Pin 4 – Lamp- Lamp driver output2, connect to EL lamp.

Pin 5 – Lamp- Lamp driver output1, connect to EL lamp.

Pin 6 –  $V_{DD}$ - Power supply for driver, connect to system  $V_{DD}$ .

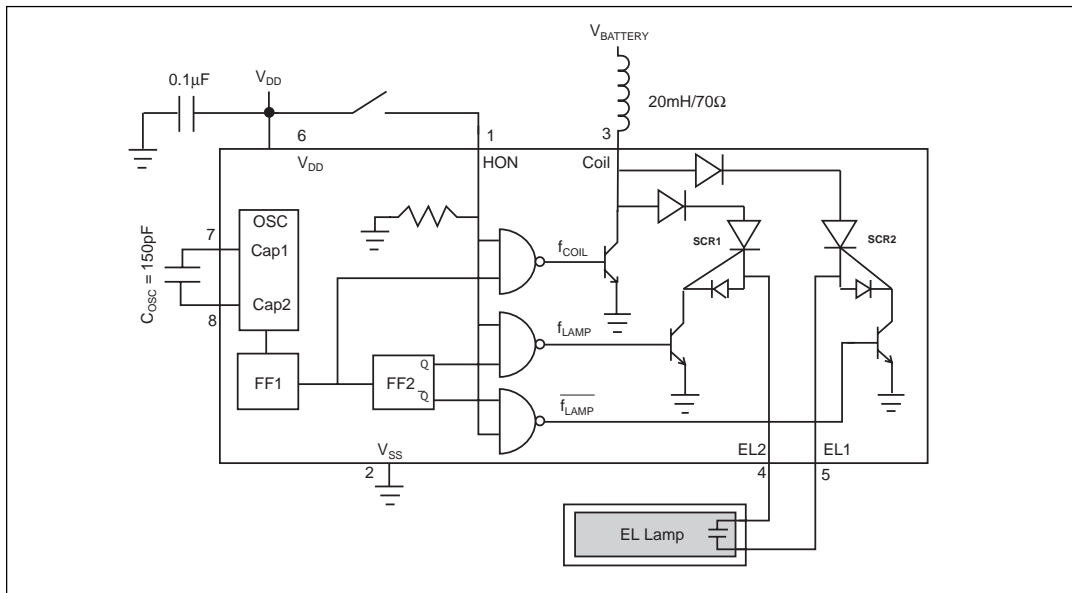
Pin 7 – Cap1- Capacitor input 1, connect to  $C_{OSC}$ .

Pin 8 – Cap2- Capacitor input 2, connect to  $C_{OSC}$ .

## THEORY OF OPERATION

The **SP4423** is made up of three basic circuit elements, an oscillator, coil, and switched H-bridge network. The oscillator provides the device with an on-chip clock source used to control the charge and discharge phases for the coil and lamp. An external capacitor connected between pins 7 and 8 allows the user to vary the oscillator frequency from 32kHz to 400kHz. The graphs on page 6 show the relationship between  $C_{OSC}$  and lamp output voltage. In general, increasing the  $C_{OSC}$  capacitor will increase the lamp output voltage and decrease the lamp frequency.

The suggested oscillator frequency is 64kHz ( $C_{OSC}=150\text{pF}$ ). The oscillator output is internally divided to create two internal control signals,  $f_{COIL}$  and  $f_{LAMP}$ . The oscillator output is internally divided down by 8 flip flops; a 64kHz signal will be divided into 8 frequencies; 32, 16, 8, 4, 2, 1, 0.5, and 0.25 Hz. The 3rd flip flop output (8kHz) is used to drive the coil (see **Figure 2** on **page 9**) and the 8th flip flop output (250Hz) is used to drive the lamp. Although the oscillator frequency can be varied to optimize the lamp output, the ratio of  $f_{COIL}/f_{LAMP}$  will always equal 32.



**SP4423 Schematic**

The on-chip oscillator of the **SP4423** can be overdriven with an external clock source by removing the  $C_{OSC}$  capacitor and connecting a clock source to pin 8 (Cap 2). The clock should have a 50% duty cycle and range from  $V_{DD} - 1V$  to ground. An external clock signal may be desirable in order to synchronize any parasitic switching noise with the system clock. The maximum external clock frequencies that can be supplied is 400kHz.

The coil is an external component connected from  $V_{BATTERY}$  to pin 3 of the **SP4423**. Energy is stored in the coil according to the equation  $E_L = 1/2LI^2$ , where  $I$  is the peak current flowing in the inductor. The current in the inductor is time dependent and is set by the "ON" time of the coil switch:  $I = (V_L/L)t_{ON}$ , where  $V_L$  is the voltage across the inductor. At the moment the switch closes, the current in the inductor is zero and the entire supply voltage (minus the  $V_{SAT}$  of the switch) is across the inductor. The current in the inductor will then ramp up at a linear rate. As the current in the inductor builds up, the voltage across the inductor will decrease due to the resistance of the coil and the "ON" resistance of the switch:  $V_L = V_{BATTERY} - I R_L - V_{SAT}$ . Since the voltage across the inductor is decreasing, the current ramp-rate also decreases which reduces the current in the coil at the end of  $t_{ON}$ , the energy stored in the inductor per coil cycle and therefore the light output. The other important issue is that maximum current (saturation current) in the coil is set by the design and manufacturer of the coil. If the parameters of the application such as  $V_{BATTERY}$ ,  $L$ ,  $RL$  or  $t_{ON}$  cause the current in the coil to increase beyond its rated  $I_{SAT}$ , excessive heat will be generated and the power efficiency will decrease with no additional light output. The **Sipex SP4423** is final tested using a 20mH/70Ω coil from CTC. For suggested coil sources see **page 10**.

The supply  $V_{DD}$  can range from 2.2 to 6.0V. It is not necessary that  $V_{DD} = V_{BATTERY}$ .  $V_{BATTERY}$  should not exceed max coil current specification. The majority of the current goes through the coil and is typically much greater than  $I_{DD}$ .

The  $f_{COIL}$  signal controls a switch that connects the end of the coil at pin 3 to ground or to open circuit. The  $f_{COIL}$  signal is a 75% duty cycle signal, switching at 1/8 the oscillator frequency. For a 64kHz oscillator  $f_{COIL}$  is 8kHz. During the time when the  $f_{COIL}$  signal is high, the coil is

connected from  $V_{BATTERY}$  to ground and a charged magnetic field is created in the coil. During the low part of  $f_{COIL}$ , the ground connection is switched open, the field collapses and the energy in the inductor is forced to flow toward the high voltage H-bridge switches.  $f_{COIL}$  will send 16 of these charge pulses to the lamp, each pulse increases the voltage drop across the lamp in discrete steps. As the voltage potential approaches its maximum, the steps become shorter (see **Figure 1** on **page 9**).

The H-bridge consists of two SCR structures that act as high voltage switches. These two switches control the polarity of how the lamp is charged. The SCR switches are controlled by the  $f_{LAMP}$  signal which is the oscillator frequency divided by 256. For a 64kHz oscillator,  $f_{LAMP} = 250Hz$ .

When the energy from the coil is released, a high voltage spike is created triggering the SCR switches. The direction of current flow is determined by which SCR is enabled. One full cycle of the H-bridge will create 16 voltage steps from ground to 80V (typical) on pins 4 and 5 which are 180 degrees out of phase with each other (see **Figure 3** on **page 9**). A differential representation of the outputs is shown in **Figure 4** on **page 9**. To minimize AC interference it is advisable to use a decoupling filter capacitor between  $V_{DD}$  and ground.

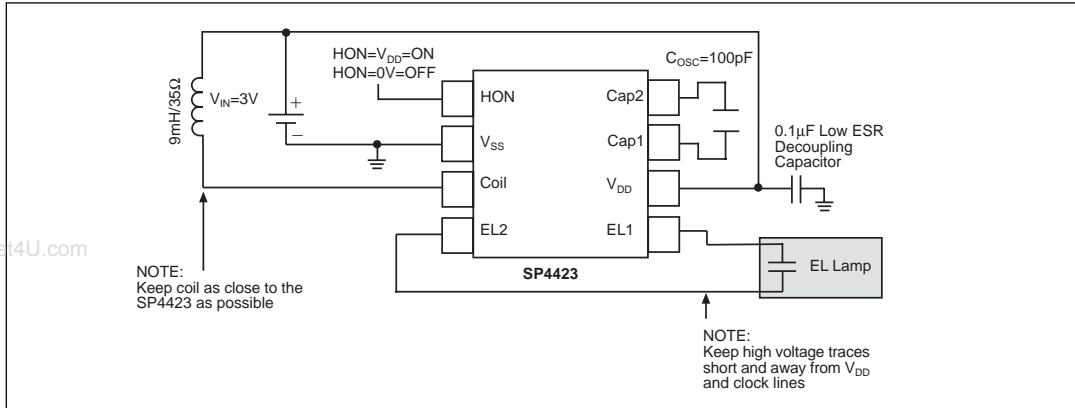
## Electroluminescent Technology

### What is electroluminescence?

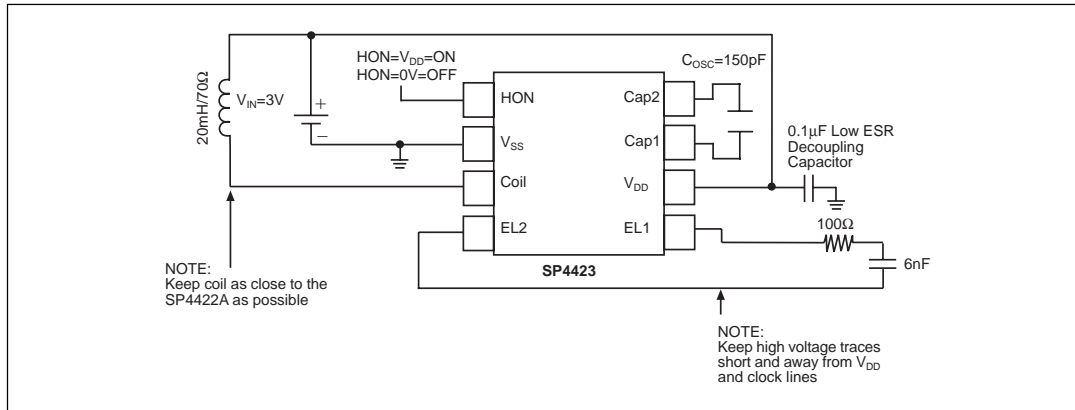
An EL lamp is basically a strip of plastic that is coated with a phosphorous material which emits light (fluoresces) when a high voltage (>40V) which was first applied across it, is removed or reversed. Long periods of DC voltages applied to the material tend to breakdown the material and reduce its lifetime. With these considerations in mind, the ideal signal to drive an EL lamp is a high voltage sine wave. Traditional approaches to achieving this type of waveform included discrete circuits incorporating a transformer, transistors, and several resistors and capacitors. This approach is large and bulky, and cannot be implemented in most handheld equipment. **Sipex** now offers low power single chip driver circuits specifically designed to drive small to medium sized electroluminescent panels. All that is required is one external inductor and capacitor.

Electroluminescent backlighting is ideal when used with LCD displays, keypads, or other backlit readouts. Its main use is to illuminate displays in dim to dark conditions for momentary periods of time. EL lamps typically consume less than LEDs or incandescent bulbs making them ideal for battery powered products. Also, EL lamps are able to evenly light an area without creating "hot spots" in the display.

The amount of light emitted is a function of the voltage applied to the lamp, the frequency at which it is applied, the lamp material used and its size. There are many variables which can be optimized for specific applications. **Sipex** supplies characterization charts to aid the designer in selecting the optimum circuit configuration (see *page 6*).

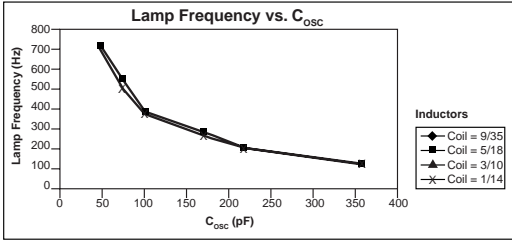


**Typical SP4423 Application Circuit**

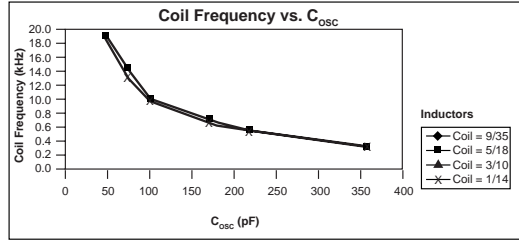


**Typical SP4423 Test Circuit**

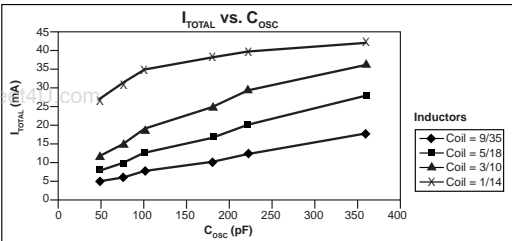
The following performance curves are intended to give the designer a relative scale from which to optimize specific applications. Absolute measurements may vary depending upon the brand of components chosen.



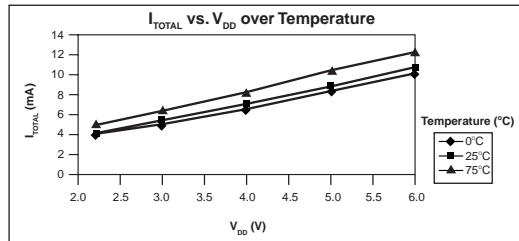
Lamp = 1sq. in., V<sub>DD</sub> = 3.0V



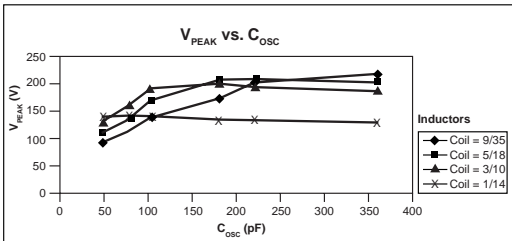
Lamp = 1sq. in., V<sub>DD</sub> = 3.0V



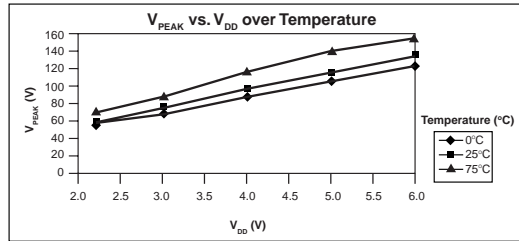
Lamp = 1sq. in., V<sub>DD</sub> = 3.0V



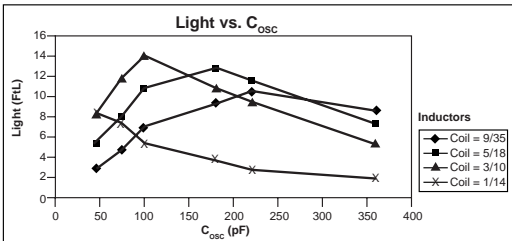
Coil = 20mH/70 ohms, C<sub>OSC</sub> = 150pF



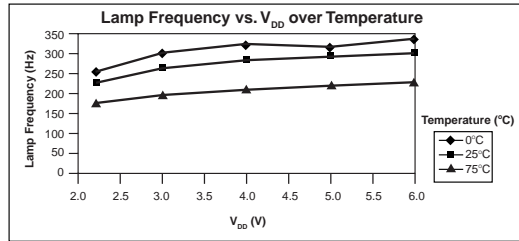
Lamp = 1sq. in., V<sub>DD</sub> = 3.0V



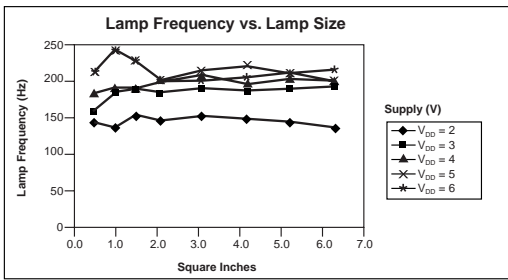
Coil = 20mH/70 ohms, C<sub>OSC</sub> = 150pF



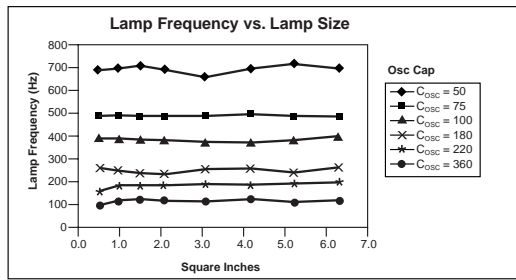
Lamp = 1sq. in., V<sub>DD</sub> = 3.0V



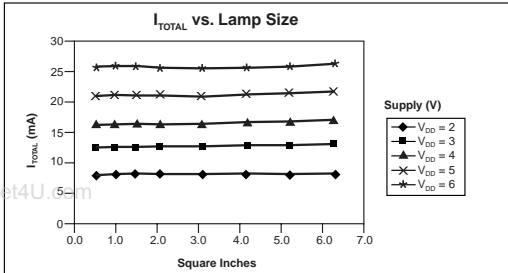
Coil = 20mH/70 ohms, C<sub>OSC</sub> = 150pF



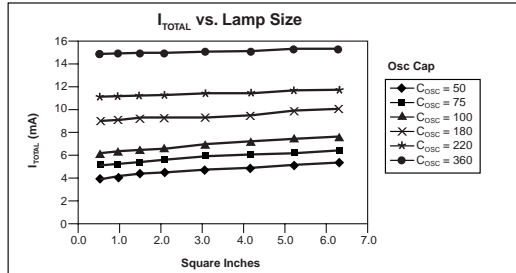
$C_{OSC} = 220\text{pF}$ , Coil = 9mH/35 ohms



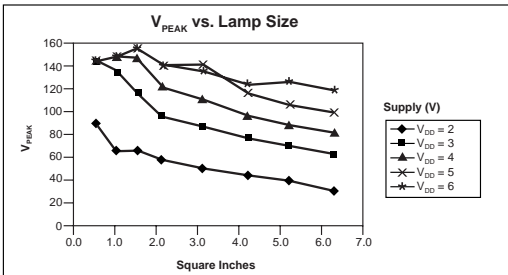
$V_{DD} = 3.0\text{V}$ , Coil = 9mH/35 ohms



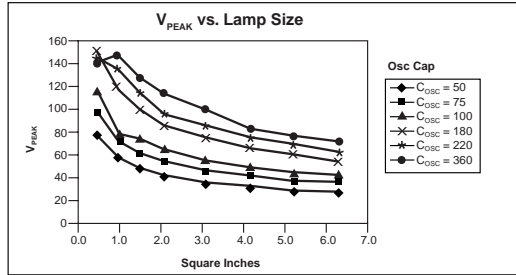
$C_{OSC} = 220\text{pF}$ , Coil = 9mH/35 ohms



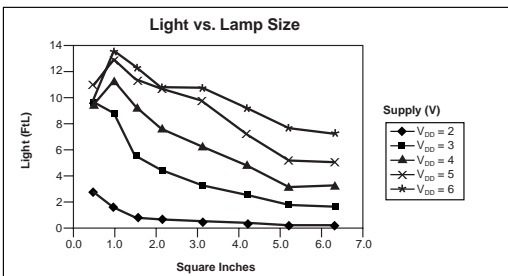
$V_{DD} = 3.0\text{V}$ , Coil = 9mH/35 ohms



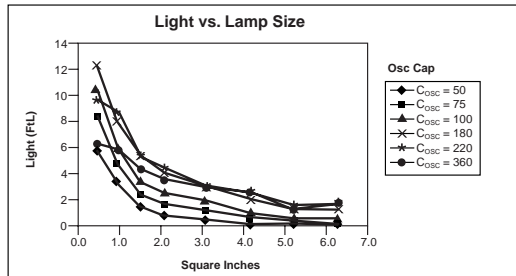
$C_{OSC} = 220\text{pF}$ , Coil = 9mH/35 ohms



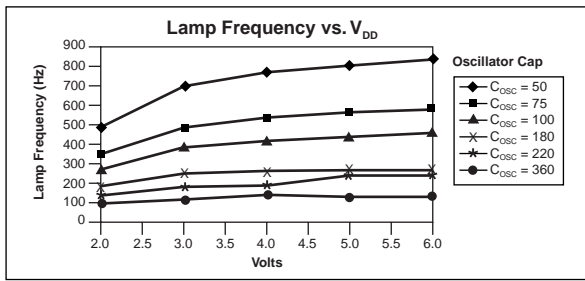
$V_{DD} = 3.0\text{V}$ , Coil = 9mH/35 ohms



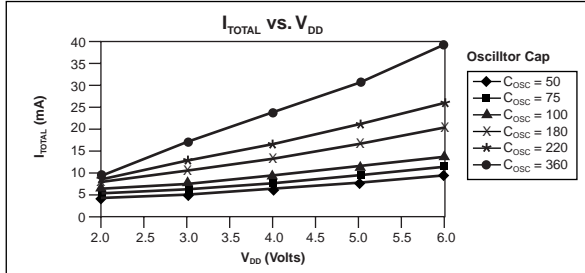
$C_{OSC} = 220\text{pF}$ , Coil = 9mH/35 ohms



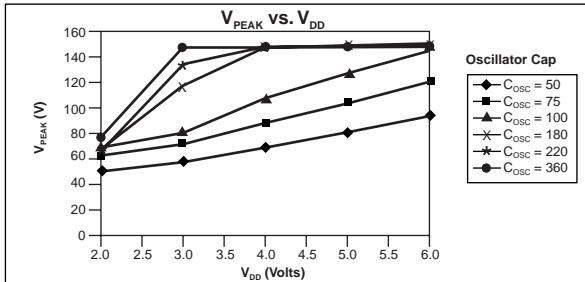
$V_{DD} = 3.0\text{V}$ , Coil = 9mH/35 ohms



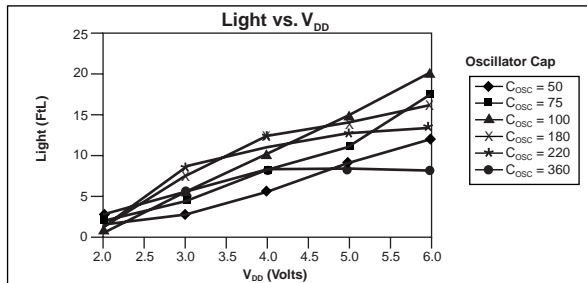
Lamp = 1sq. in., Coil = 9mH/35 ohms



Lamp = 1sq. in., Coil = 9mH/35 ohms

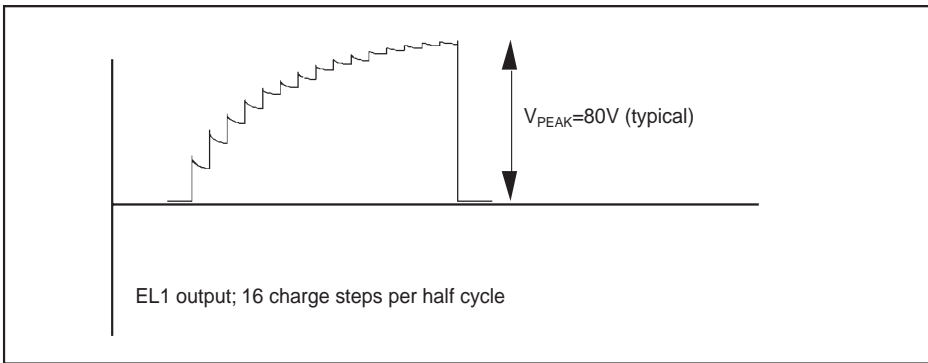


Lamp = 1sq. in., Coil = 9mH/35 ohms

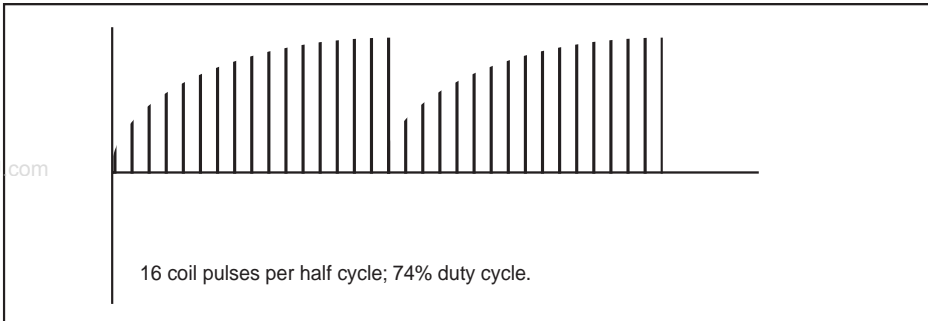


Lamp = 1sq. in., Coil = 9mH/35 ohms

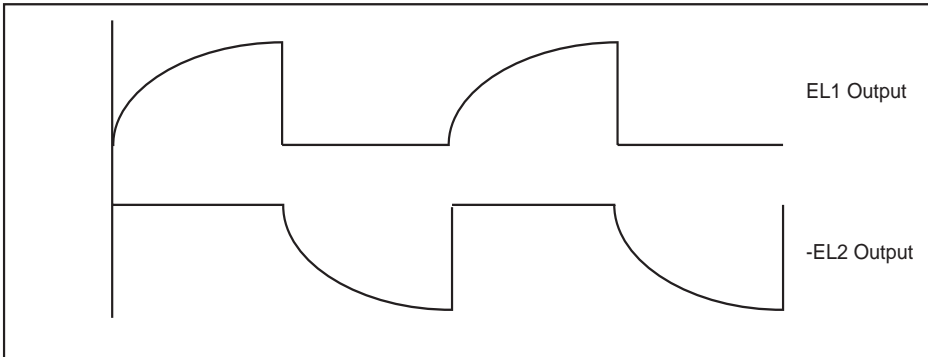




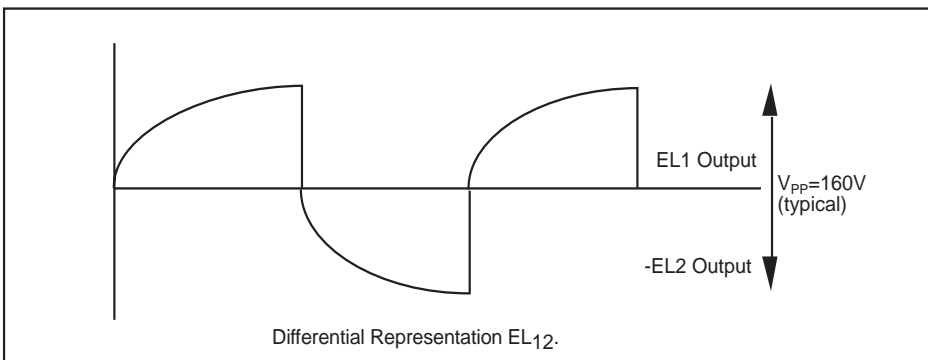
**Figure 1. EL output voltage in discrete steps at EL1 output**



**Figure 2. Voltage pulses released from the coil to the EL driver circuitry**



**Figure 3. EL voltage waveforms from the EL1 and EL2 outputs**



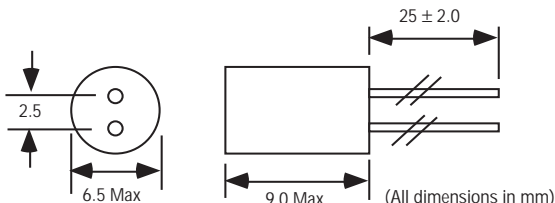
**Figure 4. EL differential output waveform of the EL1 and EL2 outputs**

The coil part numbers presented in this data sheet have been qualified as being suitable for the SP4422A product. Contact Sipex for applications assistance in choosing coil values not listed in this data sheet.

**CTC Coils LTD Hong Kong**

Ph: 85-2695-4889  
 Fax: 85-2695-1842

Mark Technologies:  
 North American Stocking  
 distributor for Sankyo and CTC  
 Ph: 905-891-0165  
 Fax: 905-891-8534



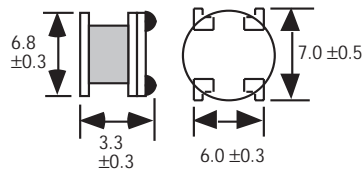
Model Numbers: CH5070AS-203K-006 (20mH, 65Ω)  
 Sipex Number: S51208-M-1021-Sipex

HITACHI METALS Ltd. Japan  
 Ph: 3-3284-4936  
 Fax: 3-3287-1945

HITACHI METALS Hong Kong  
 Ph: 852-2724-4183  
 Fax: 852-2311-2093

HITACHI METALS Singapore  
 Ph: 65-222-3077  
 Fax: 65-222-5232

HITACHI METALS Chicago, IL  
 Ph: 847-364-7200  
 Fax: 847-364-7279



Part Numbers:  
 MD735L902B (9mH + 20% 41Ω)  
 MD735L502A (5mH ± 20% 19.8Ω)

Toko Inc. Japan  
 Ph: 03-3727-1161  
 Fax: 03-3727-1176

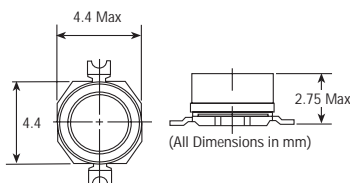
Toko Inc. Singapore  
 Ph: 255-4000  
 Fax: 250-8134

Toko Korea  
 Ph: 0551-50-5500  
 Fax: 0551-93-1110

Toko America Inc. USA  
 Ph: 847-297-0070  
 Fax: 847-699-7864

Toko Germany  
 Ph: 49-7156-96-060  
 Fax: 49-7156-96-06-26

Toko France  
 Ph: 01-4557-4465  
 Fax: 01-4554-2837



Part Numbers:  
 667MA-472N (4.7mH, 13Ω)

Toko U.K.  
 Ph: 1753-854057-9  
 Fax: 1753-8503-23

Toko Hong Kong  
 Ph: 2342-8131  
 Fax: 2341-9570

muRata USA  
 Ph: 770-436-1300  
 Fax: 770-436-3030

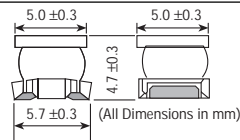
muRata Taiwan  
 Ph: 88-6429-1415-1  
 Fax: 88-6442-5292-9

muRata Hong Kong  
 Ph: 85-2237-6389-8  
 Fax: 85-2237-5556-55

muRata Europe  
 Ph: 49-9116-6870  
 Fax: 49-1166-8722-5

muRata Singapore  
 Ph: 65-758-4233  
 Fax: 65-753-6181

Part Numbers:  
 LQN6C472M04 (4.7mH, 35Ω)  
 LQN6C103M04 (10mH, 80Ω)



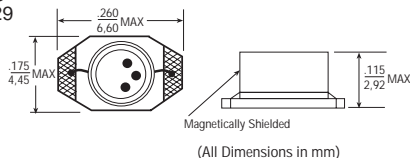
Coilcraft USA  
 Ph: 847-639-6400  
 Fax: 847-639-1469

Coilcraft Taiwan  
 Ph: 886-2-264-3646  
 Fax: 886-2-270-0294

Coilcraft Hong Kong  
 Ph: 852-770-9428  
 Fax: 852-770-0729

Coilcraft Europe  
 Ph: 44-01236-730595  
 Fax: 44-01236-730627

Coilcraft Singapore  
 Ph: 65-296-6933  
 Fax: 465-296-4463 #382



Part Numbers:  
 DS1608C-106 (10mH, 32Ω)

---

**EL polarizers/transflector manufacturers**

Nitto Denko  
San Jose, CA  
Phone: (510) 445-5400

Astra Products  
Baldwin, NJ  
Phone: (516) 223-7500  
Fax: (516) 868-2371

**EL Lamp manufacturers**

Metro Mark/Leading Edge  
Minnetonka, MN  
Phone: (800) 680-5556  
Phone: (612) 912-1700

Midori Mark Ltd.  
1-5 Komagata 2-Chome  
Taita-Ku 111-0043 Japan  
Phone: 81-03-3848-2011

Luminescent Systems Inc. (LSI)  
Lebanon, NH  
Phone: (603) 643-7766  
Fax: (603) 643-5947

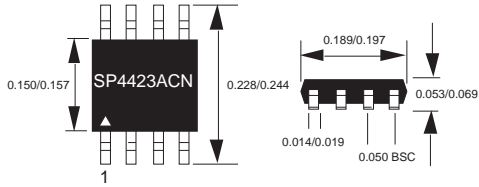
NEC Corporation  
Tokyo, Japan  
Phone: (03) 3798-9572  
Fax: (03) 3798-6134

Seiko Precision  
Tokyo, Japan  
Phone: (03) 5610-7089  
Fax: .) 5610-7177

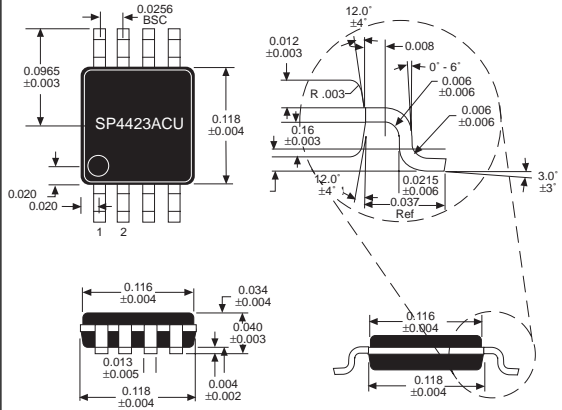
Gunze Electronics  
2113 Wells Branch Parkway  
Austin, TX 78728  
Phone: (512) 752-1299  
Fax: (512) 252-1181

All package dimensions in inches

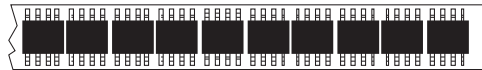
8-pin NSOIC



8-pin  $\mu$ SOIC

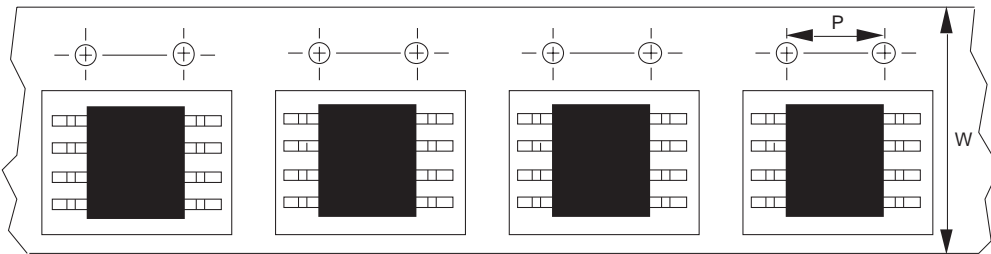


www.DataSheet4U.com



95 SP4423ACN per tube, no minimum quantity

50 SP4423ACU per tube



**NSOIC-8 13" reels: P=8mm, W=12mm**  
 **$\mu$ SOIC-8 13" reels: P=8mm, W=12mm**

Pkg.	Minimum qty per reel	Standard qty per reel	Maximum qty per reel
ACN	500	2500	3000
ACU	500	2500	3000

www.DataSheet4U.com

## ORDERING INFORMATION

Model	Temperature Range	Package Type
SP4423CN . . . . .	0°C to +70°C . . . . .	8-Pin NSOIC
SP4423CU . . . . .	0°C to +70°C . . . . .	8-Pin $\mu$ SOIC
SP4423CX . . . . .	0°C to +70°C . . . . .	Die
SP4423NEB . . . . .		NSOIC Evaluation Board
SP4423UEB . . . . .		$\mu$ SOIC Evaluation Board

Please consult the factory for pricing and availability on a Tape-On-Reel option.

www.DataSheet4U.com



SIGNAL PROCESSING EXCELLENCE

### Sipex Corporation

#### Headquarters and Sales Office

22 Linnell Circle  
Billerica, MA 01821  
TEL: (978) 667-8700  
FAX: (978) 670-9001  
e-mail: sales@sipex.com

#### Sales Office

233 South Hillview Drive  
Milpitas, CA 95035  
TEL: (408) 934-7500  
FAX: (408) 935-7600

Sipex Corporation reserves the right to make changes to any products described herein. Sipex does not assume any liability arising out of the application or use of any product or circuit described hereing; neither does it convey any license under its patent rights nor the rights of others.

[www.DataSheet4U.com](http://www.DataSheet4U.com)