

QUAD BIPOLAR OPERATIONAL AMPLIFIERS

- LOW DISTORTION RATIO
- LOW NOISE
- VERY LOW SUPPLY CURRENT
- LOW INPUT OFFSET CURRENT
- VERY LOW INPUT OFFSET VOLTAGE
- LARGE COMMON-MODE RANGE
- HIGH GAIN
- HIGH OUTPUT CURRENT
- GAIN-BANDWIDTH PRODUCT : 2.5MHz
- TEMPERATURE DRIFT : $2\mu\text{V}/^\circ\text{C}$
- LONG TERM STABILITY : $8\mu\text{V}/\text{YEAR}$
(for $T_{\text{amb}} \leq 50^\circ\text{C}$)
- THE TEB4033 AND TEF4033 ARE PIN TO PIN REPLACEMENT OF THE LS204C AND LS204I RESPECTIVELY

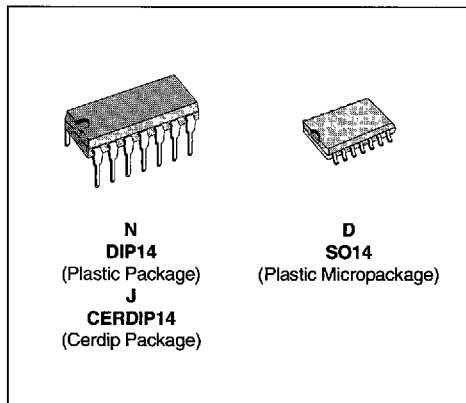

DESCRIPTION

The TEB4033, TEF4033 and TEC4033 are high performance quad-operational amplifiers intended for active filter applications. The internal phase compensation allows stable operation as voltage follower in spite of their high gain-bandwidth products. The circuits present very stable electrical characteristics over the entire supply voltage range.

PIN CONNECTIONS (top view)

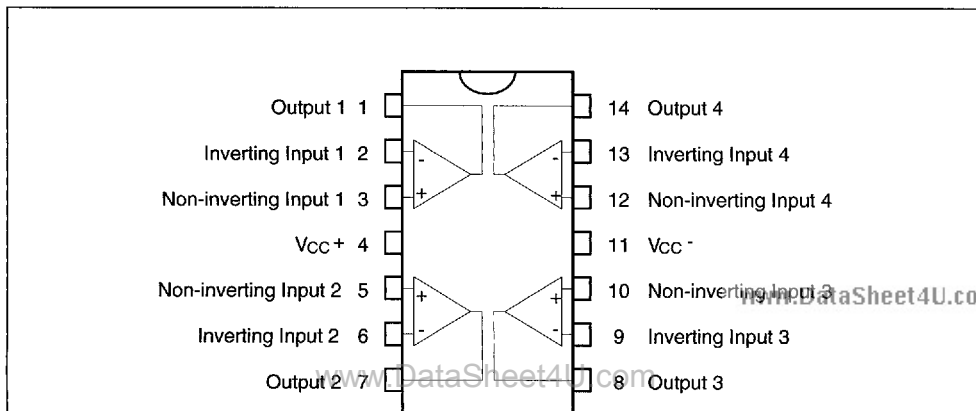

ORDER CODES

Part Number	Temperature Range	Package		
		N	J	D
TEB4033	$0^\circ\text{C}, +70^\circ\text{C}$	•	•	•
TEF4033	$-40^\circ\text{C}, +105^\circ\text{C}$	•	•	•
TEC4033	$-55^\circ\text{C}, +125^\circ\text{C}$	•	•	•

Example : TEB4033N

BLOCK DIAGRAM (1/4 TEB4033)

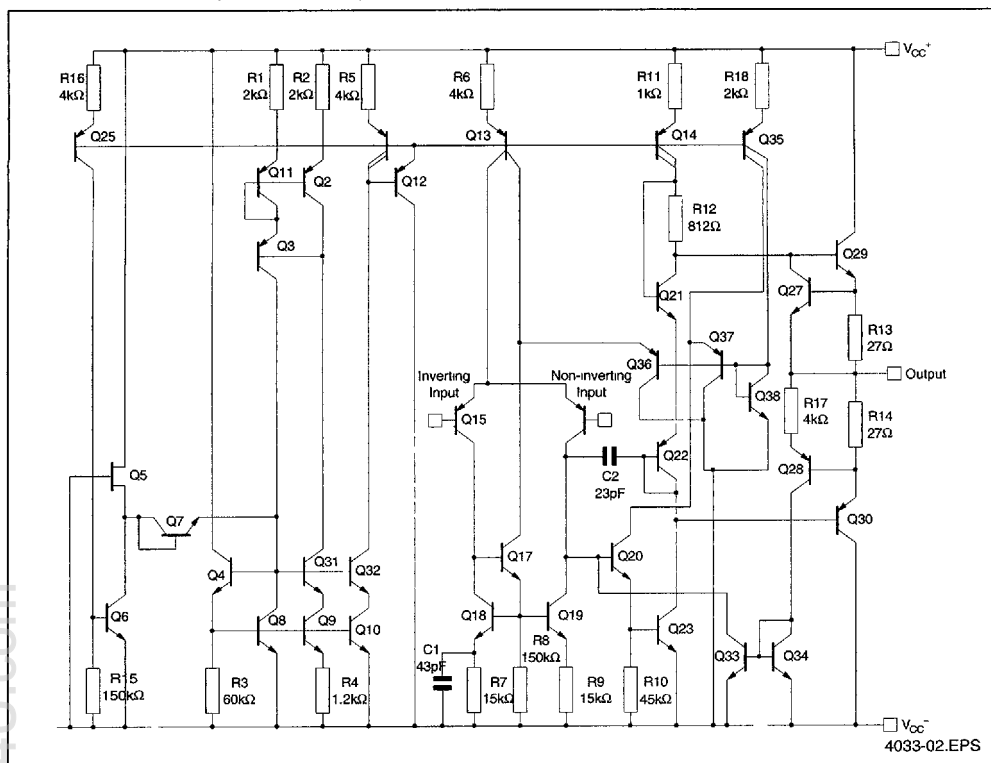

ABSOLUTE MAXIMUM RATINGS

Symbol	Parameter	Value	Unit
V_{cc}	Supply Voltage	± 18	V
V_i	Input Voltage	$\pm V_{cc}$	V
V_{id}	Differential Input Voltage	$\pm (V_{cc} - 1)$	V
P_{tot}	Power Dissipation	D suffix N suffix 400 665	mW
T_{oper}	Operating Free-air Temperature Range	TEB4033 TEF4033 TEC4033 0 to +70 -40 to +105 -55 to +125	$^{\circ}$ C
T_{stg}	Storage Temperature Range	-65 to +150	$^{\circ}$ C

ELECTRICAL CHARACTERISTICSV_{CC} = ±15V, T_{amb} = +25°C (unless otherwise specified)

Symbol	Parameter	TEB 1033 TEF 1033 TEC 1033			Unit
		Min.	Typ.	Max.	
V _{io}	Input Offset Voltage (R _S ≤ 10kΩ) T _{amb} = 25°C T _{min.} ≤ T _{amb} ≤ T _{max.}		0.3	1 3	mV
DV _{io}	Input Offset Voltage Drift		2		μV/°C
I _{io}	Input Offset Current T _{amb} = 25°C T _{min.} ≤ T _{amb} ≤ T _{max.}		5	20 40	nA
I _{ib}	Input Bias Current T _{amb} = 25°C T _{min.} ≤ T _{amb} ≤ T _{max.}		50	100 200	nA
A _{vd}	Large Signal Voltage Gain (R _L = 2kΩ, V _O = ±10V) T _{amb} = 25°C T _{min.} ≤ T _{amb} ≤ T _{max.}	80 40	120		V/mV
SVR	Supply Voltage Rejection Ratio (DV _{CC} from ±15V to ±4V) T _{amb} = 25°C T _{min.} ≤ T _{amb} ≤ T _{max.}	80 70	100		dB
I _{CC}	Supply Current, all Amp, no Load T _{amb} = 25°C T _{min.} ≤ T _{amb} ≤ T _{max.}		2	3 4	mA
V _{icm}	Input Common Mode Voltage Range T _{amb} = 25°C	±12			V
CMR	Common Mode Rejection Ratio (R _S ≤ 10kΩ, V _I = ±10V) T _{amb} = 25°C T _{min.} ≤ T _{amb} ≤ T _{max.}	80 70	100		dB
I _{os}	Output Short-circuit Current T _{amb} = 25°C T _{min.} ≤ T _{amb} ≤ T _{max.}	10 10	23	40 40	mA
±V _{opp}	Output Voltage Swing T _{amb} = 25°C T _{min.} ≤ T _{amb} ≤ T _{max.} V _{CC} = ±4V, R _L = 2kΩ, T _{amb} = 25°C V _{CC} = ±6V, R _L = 600Ω, T _{amb} = 25°C		13 12 8 4.6	14 3	V
SR	Slew-rate (V _I = ±10V, R _L = 2 kΩ, C _L = 100pF, T _{amb} = 25°C, unity gain)	0.6	1		V/μs
GBP	Gain Bandwidth Product (f = 100kHz, T _{amb} = 25°C, V _{in} = 10mV, R _L = 2kΩ, C _L = 100pF)	1.5	2		MHz
R _i	Input Resistance		1		MΩ
THD	Total Harmonic Distortion (f = 1kHz, A _v = 20dB, R _L = 2kΩ, C _L = 100pF, T _{amb} = 25°C, V _o = 2V _{pp})		0.008	0.05	%
e _n	Equivalent Input Noise Voltage (f = 1kHz) R _S = 50Ω R _S = 1kΩ R _S = 10kΩ		8 10 18	15 14	nV Hz
V _{OPP}	Large Signal Voltage Swing R _L = 10kΩ, f = 10kHz	26	28		V
∅ _m	Phase Margin		45		Degrees
V _{O1} /V _{O2}	Channel Separation	100	120		dB

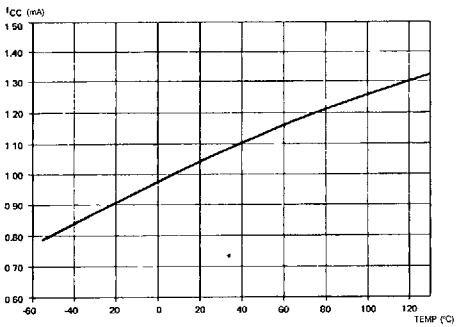

SUPPLY CURRENT VS AMBIENT TEMPERATURE

4033-03 EPS

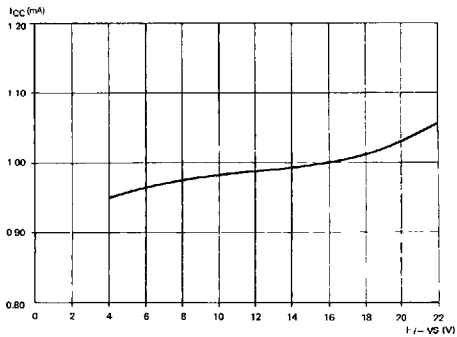

SUPPLY CURRENT VS SUPPLY VOLTAGE

4033-04 EPS

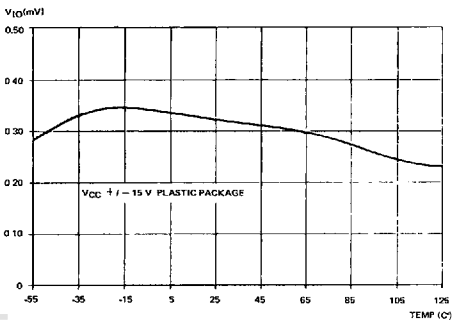

OFFSET VOLTAGE VS. AMBIENT TEMPERATURE

4033-05 EPS

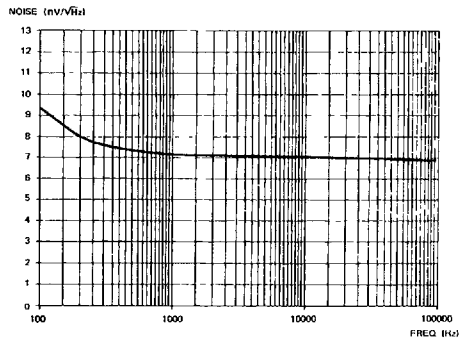

TOTAL INPUT NOISE VS FREQUENCY

4033-06.EPS

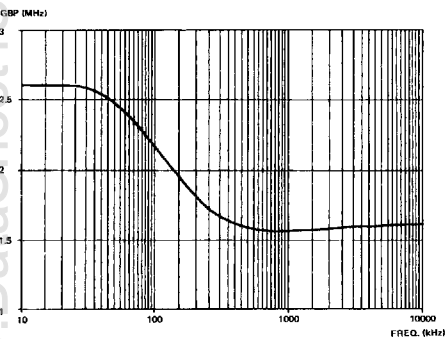

GAIN BANDWIDTH PRODUCT VS. FREQUENCY

4033-07 EPS

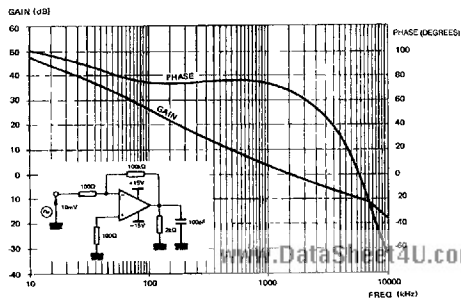

BODE PLOT

4033-08.EPS

TYPICAL APPLICATION

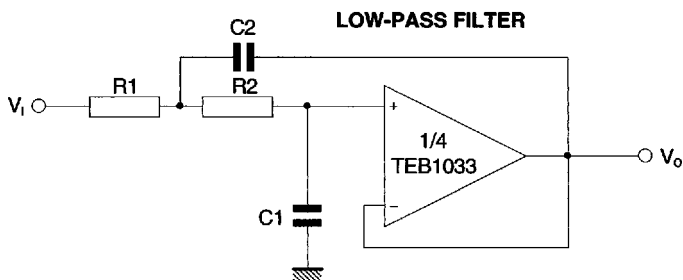

$$\frac{V_o}{V_i} = \frac{1}{1 + 2\xi \frac{S}{\omega_c} + \frac{S^2}{\omega_c^2}}$$

$\omega_c = 2\pi f_c$, with f_c = cut-off frequency
 ξ = damping factor

www.DataSheet4U.com

4033-09.EPS