

# NLX2G00

## Dual 2-Input NAND Gate

The NLX2G00 is an advanced high-speed dual 2-input CMOS NAND gate in ultra-small footprint.

The NLX2G00 input structures provide protection when voltages up to 7.0 volts are applied, regardless of the supply voltage.

### Features

- High Speed:  $t_{PD}$  2.4 ns (typical) at  $V_{CC} = 5.0$  V
- Designed for 1.65 V to 5.5 V  $V_{CC}$  Operation
- Low Power Dissipation:  $I_{CC} = 1$   $\mu$ A (Max) at  $T_A = 25^\circ$ C
- 24 mA Balanced Output Sink and Source Capability
- Balanced Propagation Delays
- Overvoltage Tolerant (OVT) Input Pins
- This is a Pb-Free Device

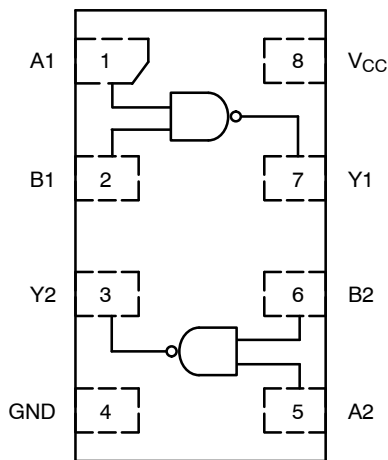

Figure 1. Pinout

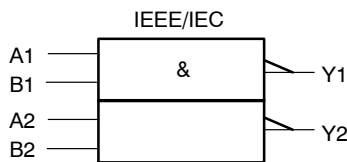

Figure 2. Logic Symbol



ON Semiconductor®

<http://onsemi.com>

### MARKING DIAGRAMS



ULLGA8  
1.45 x 1.0  
CASE 613AA

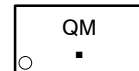

ULLGA8  
1.6 x 1.0  
CASE 613AB

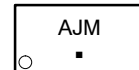

ULLGA8  
1.95 x 1.0  
CASE 613AC

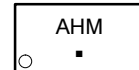

XX = Specific Device Code  
M = Date Code  
▪ = Pb-Free Package

### PIN ASSIGNMENT

Pin	Function
1	A1
2	B1
3	Y2
4	GND
5	A2
6	B2
7	Y1
8	$V_{CC}$

### FUNCTION TABLE

$$Y = \overline{AB}$$

Inputs		Output
A	B	Y
L	L	H
L	H	H
H	L	H
H	H	L

H = HIGH Logic Level  
L = LOW Logic Level

### ORDERING INFORMATION

See detailed ordering and shipping information in the package dimensions section on page 4 of this data sheet.

# NLX2G00

## MAXIMUM RATINGS

Symbol	Parameter	Value	Unit
$V_{CC}$	DC Supply Voltage	-0.5 to +7.0	V
$V_{IN}$	DC Input Voltage	-0.5 to +7.0	V
$V_{OUT}$	DC Output Voltage	-0.5 to $V_{CC} + 0.5$	V
$I_{IK}$	DC Input Diode Current $V_{IN} < GND$	-50	mA
$I_{OK}$	DC Output Diode Current $V_{OUT} < GND$	-50	mA
$I_O$	DC Output Source/Sink Current	$\pm 50$	mA
$I_{CC}$	DC Supply Current per Supply Pin	$\pm 100$	mA
$I_{GND}$	DC Ground Current per Ground Pin	$\pm 100$	mA
$T_{STG}$	Storage Temperature Range	-65 to +150	°C
$T_L$	Lead Temperature, 1 mm from Case for 10 Seconds	TBD	°C
$T_J$	Junction Temperature Under Bias	TBD	°C
$\theta_{JA}$	Thermal Resistance (Note 1)	TBD	°C/W
$P_D$	Power Dissipation in Still Air at 85°C	TBD	mW
MSL	Moisture Sensitivity	Level 1	
$F_R$	Flammability Rating Oxygen Index: 28 to 34	UL 94 V-0 @ 0.125 in	
$V_{ESD}$	ESD Withstand Voltage Human Body Model (Note 2) Machine Model (Note 3) Charged Device Model (Note 4)	> 2000 > 200 N/A	V
$I_{Latchup}$	Latchup Performance Above $V_{CC}$ and Below GND at 125°C (Note 5)	$\pm 500$	mA

Stresses exceeding Maximum Ratings may damage the device. Maximum Ratings are stress ratings only. Functional operation above the Recommended Operating Conditions is not implied. Extended exposure to stresses above the Recommended Operating Conditions may affect device reliability.

1. Measured with minimum pad spacing on an FR4 board, using 10 mm-by-1 inch, 2-ounce copper trace with no air flow.
2. Tested to EIA/JESD22-A114-A.
3. Tested to EIA/JESD22-A115-A.
4. Tested to JESD22-C101-A.
5. Tested to EIA/JESD78.

## RECOMMENDED OPERATING CONDITIONS

Symbol	Parameter	Min	Max	Unit
$V_{CC}$	Power DC Supply Voltage Operating Data Retention Only	1.65 1.5	5.5 5.5	V
$V_{IN}$	Digital Input Voltage (Note 6)	0	5.5	V
$V_{OUT}$	Output Voltage	0	$V_{CC}$	V
$T_A$	Operating Free-Air Temperature	-55	+125	°C
$\Delta t/\Delta V$	Input Transition Rise or Fall Rate $V_{CC} = 1.8 V \pm 0.15 V$ $V_{CC} = 2.5 V \pm 0.2 V$ $V_{CC} = 3.3 V \pm 0.3 V$ $V_{CC} = 5.0 V \pm 0.5 V$	0 0 0 0	20 20 10 5	ns/V

6. Unused inputs may not be left open. All inputs must be tied to a high- or low-logic input voltage level.

# NLX2G00

## DC ELECTRICAL CHARACTERISTICS

Symbol	Parameter	Condition	V <sub>CC</sub> (V)	T <sub>A</sub> = 25°C			T <sub>A</sub> ≤ 85°C		T <sub>A</sub> = -55°C to +125°C		Unit
				Min	Typ	Max	Min	Max	Min	Max	
V <sub>IH</sub>	High-Level Input Voltage		1.65 2.3 to 5.5	0.75 x V <sub>CC</sub> 0.7 x V <sub>CC</sub>			0.75 x V <sub>CC</sub> 0.7 x V <sub>CC</sub>		0.75 x V <sub>CC</sub> 0.7 x V <sub>CC</sub>		V
V <sub>IL</sub>	Low-Level Input Voltage		1.65 2.3 to 5.5			0.25 x V <sub>CC</sub> 0.3 x V <sub>CC</sub>		0.25 x V <sub>CC</sub> 0.3 x V <sub>CC</sub>		0.25 x V <sub>CC</sub> 0.3 x V <sub>CC</sub>	V
V <sub>OH</sub>	High-Level Output Voltage	V <sub>IN</sub> = V <sub>IH</sub> or V <sub>IL</sub> , I <sub>OH</sub> = -100 μA	1.65 to 5.5	V <sub>CC</sub> - 0.1	V <sub>CC</sub>		V <sub>CC</sub> - 0.1		V <sub>CC</sub> - 0.1		V
		V <sub>IN</sub> = V <sub>IH</sub> or V <sub>IL</sub> I <sub>OH</sub> = -4 mA	1.65	1.29	1.5		1.29		1.29		
		I <sub>OH</sub> = -8 mA	2.3	1.9	2.1		1.9		1.9		
		I <sub>OH</sub> = -12 mA	2.7	2.2	2.4		2.2		2.2		
		I <sub>OH</sub> = -16 mA	3.0	2.4	2.7		2.4		2.4		
		I <sub>OH</sub> = -24 mA	3.0	2.3	2.5		2.3		2.3		
I <sub>OH</sub> = -32 mA	4.5	3.8	4.0		3.8		3.8				
V <sub>OL</sub>	Low-Level Output Voltage	V <sub>IN</sub> = V <sub>IH</sub> or V <sub>IL</sub> , I <sub>OL</sub> = 100 μA	1.65 to 5.5			0.1		0.1		0.1	V
		V <sub>IN</sub> = V <sub>IH</sub> or V <sub>IL</sub> I <sub>OL</sub> = 4 mA	1.65		0.08	0.24		0.24		0.24	
		I <sub>OL</sub> = 8 mA	2.3		0.20	0.3		0.3		0.3	
		I <sub>OL</sub> = 12 mA	2.7		0.22	0.4		0.4		0.4	
		I <sub>OL</sub> = 16 mA	3.0		0.28	0.4		0.4		0.4	
		I <sub>OL</sub> = 24 mA	3.0		0.38	0.55		0.55		0.55	
I <sub>OL</sub> = 32 mA	4.5		0.42	0.55		0.55		0.55			
I <sub>IN</sub>	Input Leakage Current	0 ≤ V <sub>IN</sub> ≤ 5.5 V	0 to 5.5			±0.1		±1.0		±1.0	μA
I <sub>OFF</sub>	Power-Off Input Leakage Current	V <sub>IN</sub> = 5.5 V	0			1.0		10		10	μA
I <sub>CC</sub>	Quiescent Supply Current	0 ≤ V <sub>IN</sub> ≤ 5.5 V	5.5			1.0		10		10	μA

## AC ELECTRICAL CHARACTERISTICS t<sub>R</sub> = t<sub>F</sub> = 2.5 ns

Symbol	Parameter	V <sub>CC</sub> (V)	Test Condition	T <sub>A</sub> = 25°C			T <sub>A</sub> ≤ 85°C		T <sub>A</sub> = -55°C to +125°C		Unit
				Min	Typ	Max	Min	Max	Min	Max	
t <sub>PLH</sub> t <sub>PHL</sub>	Propagation Delay Input A to Output	1.65 to 1.95	R <sub>L</sub> = 1 MΩ, C <sub>L</sub> = 15 pF	2.0	5.7	10.5	2.0	11.0	TBD	TBD	ns
		2.3 to 2.7	R <sub>L</sub> = 1 MΩ, C <sub>L</sub> = 15 pF	1.2	3.2	5.3	1.2	5.7	TBD	TBD	
		3.0 to 3.6	R <sub>L</sub> = 1 MΩ, C <sub>L</sub> = 15 pF	0.8	2.4	3.7	0.8	4.0	TBD	TBD	
			R <sub>L</sub> = 500 Ω, C <sub>L</sub> = 50 pF	1.2	3.0	4.6	1.2	4.9	TBD	TBD	
4.5 to 5.5	R <sub>L</sub> = 1 MΩ, C <sub>L</sub> = 15 pF	0.5	1.9	2.9	0.5	3.2	TBD	TBD			
	R <sub>L</sub> = 500 Ω, C <sub>L</sub> = 50 pF	0.8	2.4	3.6	0.8	3.9	TBD	TBD			
C <sub>IN</sub>	Input Capacitance	5.5	V <sub>IN</sub> = 0 V or V <sub>CC</sub>		2.5						pF
C <sub>PD</sub>	Power Dissipation Capacitance (Note 7)	3.3	10 MHz, V <sub>IN</sub> = 0V or V <sub>CC</sub>		9						pF
		5.5			11						

7. C<sub>PD</sub> is defined as the value of the internal equivalent capacitance which is calculated from the operating current consumption without load. Average operating current can be obtained by the equation: I<sub>CC(OPR)</sub> = C<sub>PD</sub> • V<sub>CC</sub> • f<sub>in</sub> + I<sub>CC</sub>. C<sub>PD</sub> is used to determine the no-load dynamic power consumption; P<sub>D</sub> = C<sub>PD</sub> • V<sub>CC</sub><sup>2</sup> • f<sub>in</sub> + I<sub>CC</sub> • V<sub>CC</sub>.

# NLX2G00

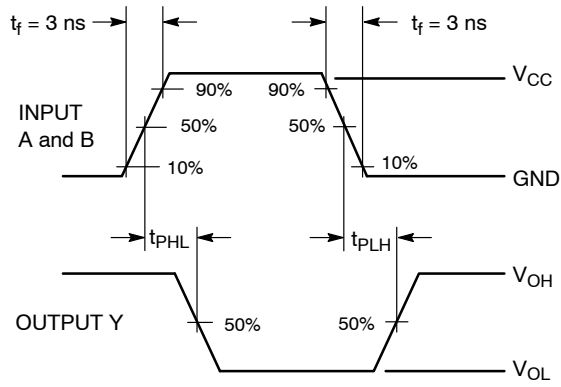

**Figure 3. Switching Waveform**

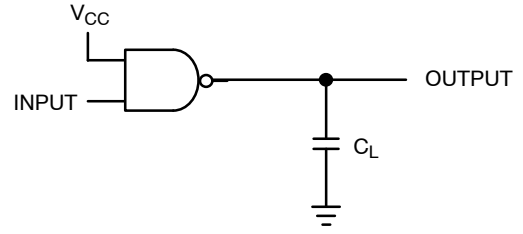

A 1-MHz square input wave is recommended for propagation delay tests.

**Figure 4. Test Circuit**

## ORDERING INFORMATION

Device	Package	Shipping†
NLX2G00AMX1TCG	ULLGA8, 1.95 x 1.0, 0.5P (Pb-Free)	3000 / Tape & Reel
NLX2G00BMX1TCG	ULLGA8, 1.6 x 1.0, 0.4P (Pb-Free)	3000 / Tape & Reel
NLX2G00CMX1TCG	ULLGA8, 1.45 x 1.0, 0.35P (Pb-Free)	3000 / Tape & Reel

†For information on tape and reel specifications, including part orientation and tape sizes, please refer to our Tape and Reel Packaging Specifications Brochure, BRD8011/D.

# NLX2G00

## PACKAGE DIMENSIONS

ULLGA8 1.45x1.0, 0.35P  
CASE 613AA-01  
ISSUE A

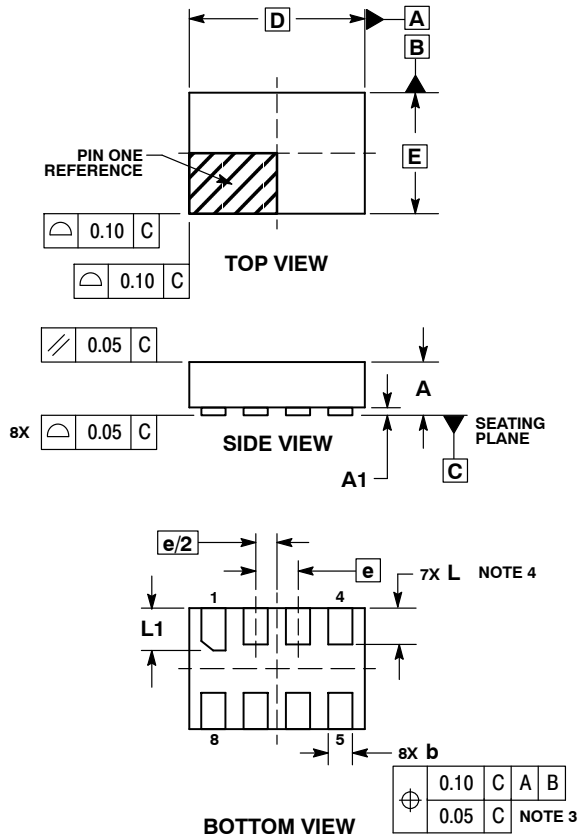

**NOTES:**

1. DIMENSIONING AND TOLERANCING PER ASME Y14.5M, 1994.
2. CONTROLLING DIMENSION: MILLIMETERS.
3. DIMENSION b APPLIES TO PLATED TERMINAL AND IS MEASURED BETWEEN 0.15 AND 0.30 mm FROM THE TERMINAL TIP.
4. A MAXIMUM OF 0.05 PULL BACK OF THE PLATED TERMINAL FROM THE EDGE OF THE PACKAGE IS ALLOWED.

DIM	MILLIMETERS	
	MIN	MAX
A	---	0.40
A1	0.00	0.05
b	0.15	0.25
D	1.45 BSC	
E	1.00 BSC	
e	0.35 BSC	
L	0.25	0.35
L1	0.30	0.40

**MOUNTING FOOTPRINT  
SOLDERMASK DEFINED\***

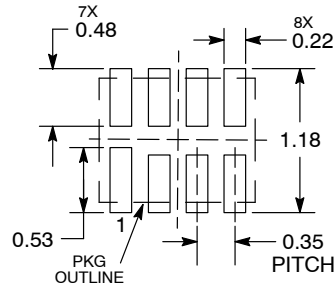

DIMENSIONS: MILLIMETERS

\*For additional information on our Pb-Free strategy and soldering details, please download the ON Semiconductor Soldering and Mounting Techniques Reference Manual, SOLDERRM/D.

# NLX2G00

## PACKAGE DIMENSIONS

ULLGA8 1.6x1.0, 0.4P  
CASE 613AB-01  
ISSUE A

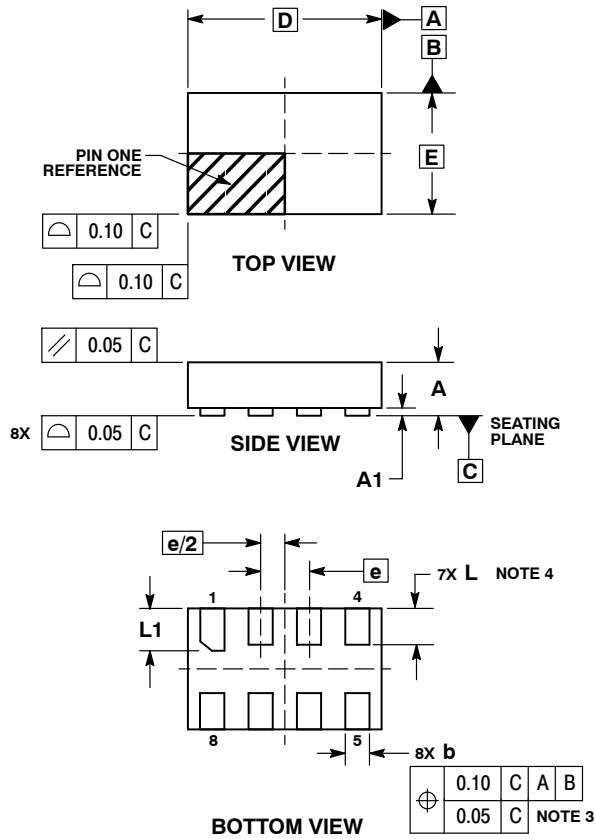

**NOTES:**

1. DIMENSIONING AND TOLERANCING PER ASME Y14.5M, 1994.
2. CONTROLLING DIMENSION: MILLIMETERS.
3. DIMENSION b APPLIES TO PLATED TERMINAL AND IS MEASURED BETWEEN 0.15 AND 0.30 mm FROM THE TERMINAL TIP.
4. A MAXIMUM OF 0.05 PULL BACK OF THE PLATED TERMINAL FROM THE EDGE OF THE PACKAGE IS ALLOWED.

MILLIMETERS		
DIM	MIN	MAX
A	---	0.40
A1	0.00	0.05
b	0.15	0.25
D	1.60 BSC	
E	1.00 BSC	
e	0.40 BSC	
L	0.25	0.35
L1	0.30	0.40

**MOUNTING FOOTPRINT  
SOLDERMASK DEFINED\***

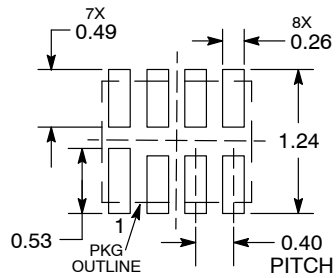

DIMENSIONS: MILLIMETERS

\*For additional information on our Pb-Free strategy and soldering details, please download the ON Semiconductor Soldering and Mounting Techniques Reference Manual, SOLDERRM/D.

# NLX2G00

## PACKAGE DIMENSIONS

ULLGA8 1.95x1.0, 0.5P  
CASE 613AC-01  
ISSUE A

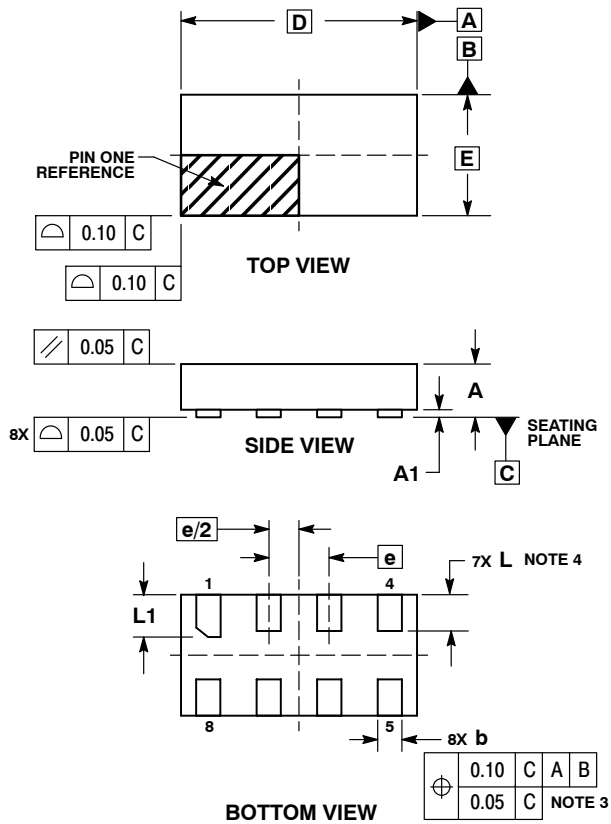

**NOTES:**

1. DIMENSIONING AND TOLERANCING PER ASME Y14.5M, 1994.
2. CONTROLLING DIMENSION: MILLIMETERS.
3. DIMENSION b APPLIES TO PLATED TERMINAL AND IS MEASURED BETWEEN 0.15 AND 0.30 mm FROM THE TERMINAL TIP.
4. A MAXIMUM OF 0.05 PULL BACK OF THE PLATED TERMINAL FROM THE EDGE OF THE PACKAGE IS ALLOWED.

MILLIMETERS		
DIM	MIN	MAX
A	---	0.40
A1	0.00	0.05
b	0.15	0.25
D	1.95 BSC	
E	1.00 BSC	
e	0.50 BSC	
L	0.25	0.35
L1	0.30	0.40

**MOUNTING FOOTPRINT  
SOLDERMASK DEFINED\***

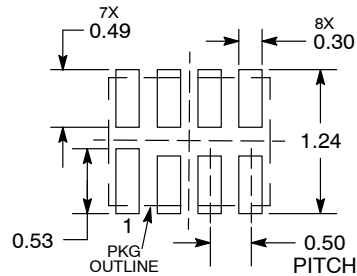

DIMENSIONS: MILLIMETERS

\*For additional information on our Pb-Free strategy and soldering details, please download the ON Semiconductor Soldering and Mounting Techniques Reference Manual, SOLDERRM/D.

ON Semiconductor and are registered trademarks of Semiconductor Components Industries, LLC (SCILLC). SCILLC reserves the right to make changes without further notice to any products herein. SCILLC makes no warranty, representation or guarantee regarding the suitability of its products for any particular purpose, nor does SCILLC assume any liability arising out of the application or use of any product or circuit, and specifically disclaims any and all liability, including without limitation special, consequential or incidental damages. "Typical" parameters which may be provided in SCILLC data sheets and/or specifications can and do vary in different applications and actual performance may vary over time. All operating parameters, including "Typicals" must be validated for each customer application by customer's technical experts. SCILLC does not convey any license under its patent rights nor the rights of others. SCILLC products are not designed, intended, or authorized for use as components in systems intended for surgical implant into the body, or other applications intended to support or sustain life, or for any other application in which the failure of the SCILLC product could create a situation where personal injury or death may occur. Should Buyer purchase or use SCILLC products for any such unintended or unauthorized application, Buyer shall indemnify and hold SCILLC and its officers, employees, subsidiaries, affiliates, and distributors harmless against all claims, costs, damages, and expenses, and reasonable attorney fees arising out of, directly or indirectly, any claim of personal injury or death associated with such unintended or unauthorized use, even if such claim alleges that SCILLC was negligent regarding the design or manufacture of the part. SCILLC is an Equal Opportunity/Affirmative Action Employer. This literature is subject to all applicable copyright laws and is not for resale in any manner.

**PUBLICATION ORDERING INFORMATION**

**LITERATURE FULFILLMENT:**  
Literature Distribution Center for ON Semiconductor  
P.O. Box 5163, Denver, Colorado 80217 USA  
**Phone:** 303-675-2175 or 800-344-3860 Toll Free USA/Canada  
**Fax:** 303-675-2176 or 800-344-3867 Toll Free USA/Canada  
**Email:** orderlit@onsemi.com

**N. American Technical Support:** 800-282-9855 Toll Free USA/Canada  
**Europe, Middle East and Africa Technical Support:**  
Phone: 421 33 790 2910  
**Japan Customer Focus Center**  
Phone: 81-3-5773-3850

**ON Semiconductor Website:** [www.onsemi.com](http://www.onsemi.com)  
**Order Literature:** <http://www.onsemi.com/orderlit>  
For additional information, please contact your local Sales Representative