

U584/5/7

LINEAR INTEGRATED CIRCUIT

3~8 AMP 5V TO 3.3V VOLTAGE CONVERSION REGULATOR

DESCRIPTION

The Contek U584/585/587 voltage regulators are monolithic integrated circuits, designed for use in applications requiring a well regulated positive output voltage with +5V input. The output voltage can be adjustable from 3.8 V down to 1.3V.

FEATURES

- *Low dropout performance.
- *Adjustable output down to 1.3V.
- *Line regulation typically below 0.1%.
- *Load regulation typically below 0.1%.
- *Output current can be up to 8 A for Contek U584.

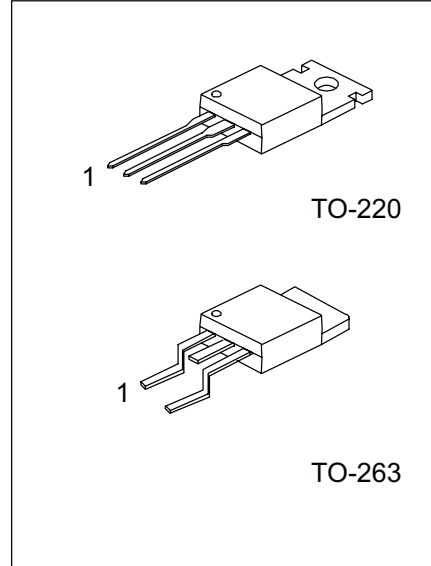

1: COMMON 2: OUTPUT 3: INPUT

BLOCK DIAGRAM

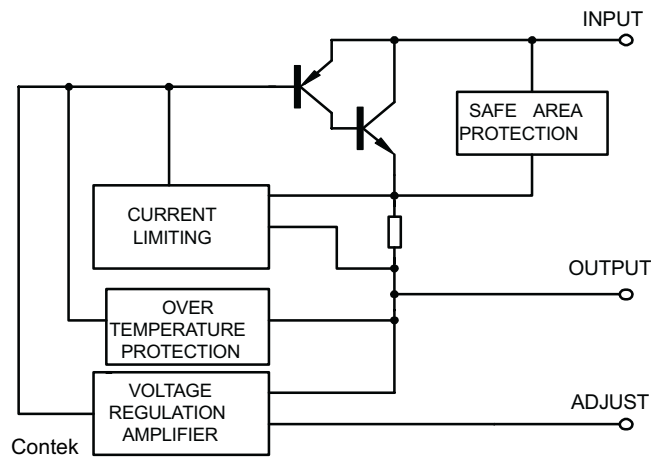

Contek Microelectronics Co.,Ltd.

<http://www.contek-ic.com> E-mail:sales@contek-ic.com

U584/5/7

LINEAR INTEGRATED CIRCUIT

ABSOLUTE MAXIMUM RATINGS

PARAMETER	SYMBOL	VALUE	UNIT
Input Voltage	V _{IN}	7	V
Power Dissipation	P _D	Internally Limited	W
Operating Junction Temperature Range	T _J	0 to 125	C
Storage Temperature	T _{STG}	-65 to 150	C
Lead Temperature (Soldering 10 Sec.)	T _{LEAD}	300	C

www.DataSheet4U.com

ELECTRICAL CHARACTERISTICS

PARAMETER	SYMBOL	TEST CONDITIONS	MIN	TYP	MAX	UNIT
Reference Voltage	U584	1.3V<=(V _{IN} -V _{OUT})<=3V, 10mA<=I _{OUT} <=8A	* 1.225 (-2%)	1.25	1.275 (+2%)	V
	U585	1.3V<=(V _{IN} -V _{OUT})<=3V, 10mA<=I _{OUT} <=5A				
	U587	1.3V<=(V _{IN} -V _{OUT})<=3V, 10mA<=I _{OUT} <=3A				
Line Regulation (Note 1.2)	U584/5/7	2.75V<=V _{IN} <=7V, I _{OUT} = I _{FULLLOAD}		0.1	0.2	%
Load Regulation (Note 1, 2, 3)	U584/5/7	V _{IN} -V _{OUT} =1.3V, T _J =25 C, 10mA<=I _{OUT} <=I _{FULLLOAD}	*	0.2	1.0	%
Dropout Voltage	U584/5/7	V _{REF} =1%, DUT= I _{FULLLOAD} T _J >=25 C T _J <=25 C		1.2	1.3	V
				1.2	1.35	V
Current Limit (Note 3)	U584	V _{IN} -V _{OUT} =1.3 V	* 8.0	8.5		A
	U585	V _{IN} -V _{OUT} =1.3 V	* 5.0	5.5		A
	U587	V _{IN} -V _{OUT} =1.3 V	* 3.0	3.6		A
Adjust Pin Current	U584/5/7			55	120	μA
Adjust Pin Current Change (Note 3)	U584/5/7	1.5V<=(V _{IN} -V _{OUT}) <=3 V, 10mA<=I _{OUT} <=I _{FULLLOAD}		0.2	5	mA
Minimum Load Current	U584/5/7	1.5V<=(V _{IN} -V _{OUT}) <=3V,	*	2	10	mA
Quiescent Circuit Current	U584/5/7	V _{IN} <=5V	*	8	13	mA
Ripple Rejection	U584/5/7	f=120Hz, C _{OUT} =25μA, T _{ant} , V _{IN} -V _{OUT} =1.3 V, I _{OUT} = I _{FULLLOAD}	60	72		dB
Temperature Stability				0.5		%
Long-Term Stability		T _A =25 C, 1000Hrs		0.03	1.0	%
RMS Output Noise (% of V _{OUT})		T _A =125 C, 10Hz<=f<=10kHz		0.03		%
Thermal Resistance Junction to Case	U584				1.6	C /W
	U585/7				3.0	C /W

The * denotes specifications which apply over the specified operating temperature range.

Note 1: Load and line regulation are measured at a constant junction temperature by low duty cycle pulse testing.



Contek Microelectronics Co.,Ltd.

<http://www.contek-ic.com> E-mail:sales@contek-ic.com

2

U584/5/7

LINEAR INTEGRATED CIRCUIT

Note 2: Line and load regulation are guaranteed up to the maximum power dissipation(15W for the Contek U584, 10W for the Contek U585). Power dissipation is determined by input / output differential and the output current. Guaranteed maximum output power will not be available over the full input-output voltage range.

Note 3: IFULLLOAD is defined as the maximum value of output load current as a function of input-to-output voltage. Output current can be different for different input-to-output voltage.

APPLICATION CIRCUIT

www.DataSheet4U.com

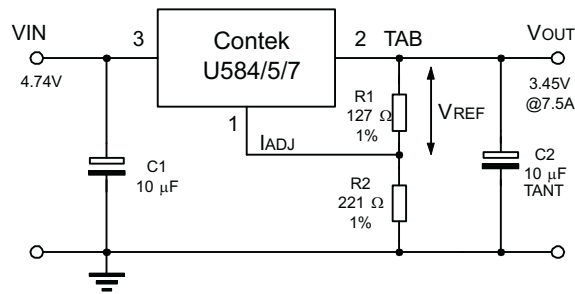

REQUIRED FOR STABILITY

$$V_{OUT} = V_{REF} * (1 + R2/R1) + I_{ADJ} * R2$$



Contek Microelectronics Co.,Ltd.

<http://www.contek-ic.com> E-mail:sales@contek-ic.com

TYPICAL PERFORMANCE CHARACTERISTICS

www.DataSheet4U.com

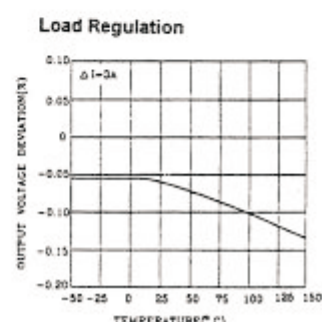
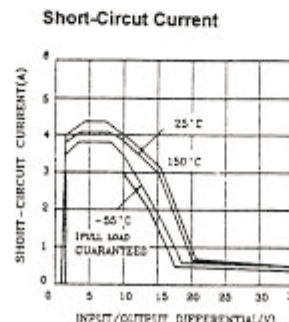
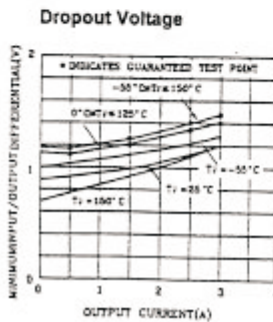
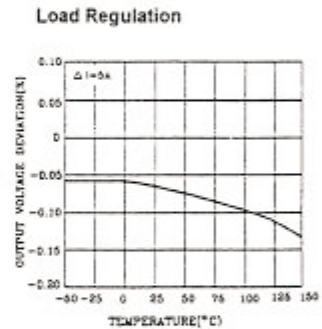
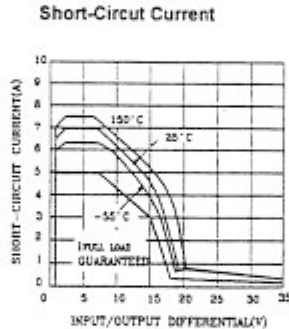
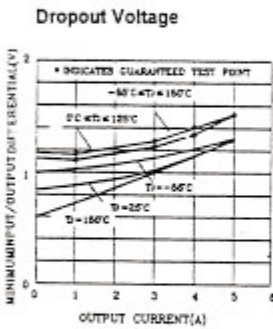
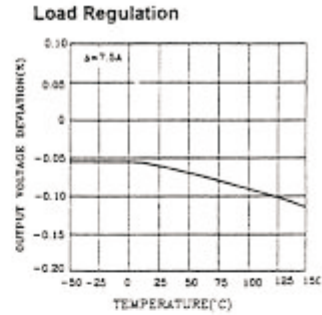
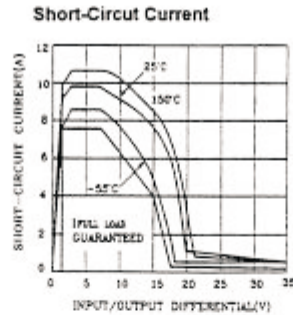
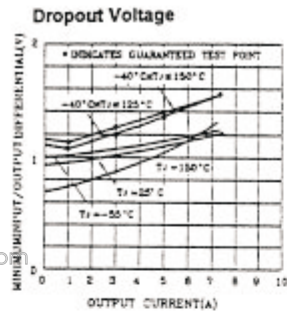

Contek Microelectronics Co.,Ltd.

<http://www.contek-ic.com> E-mail:sales@contek-ic.com

TYPICAL PERFORMANCE CHARACTERISTICS

www.DataSheet4U.com

Minimum Operating Current

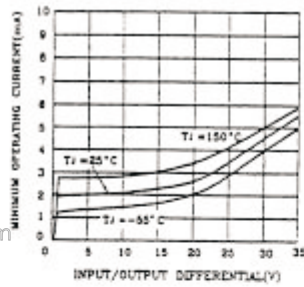

Temperature Stability

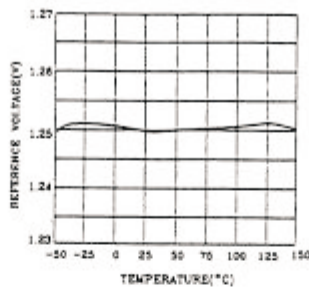

Adjust Pin Current

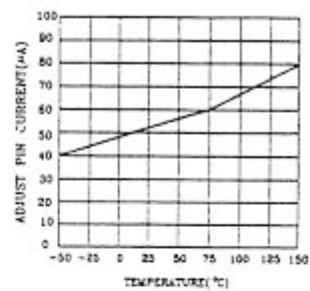

Ripple Rejection

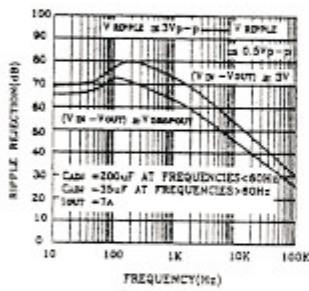

Ripple Rejection vs Current

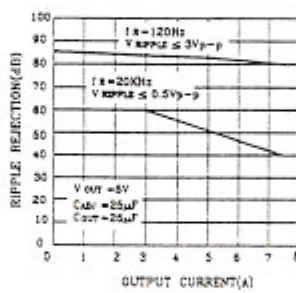

Maximum Power Dissipation*

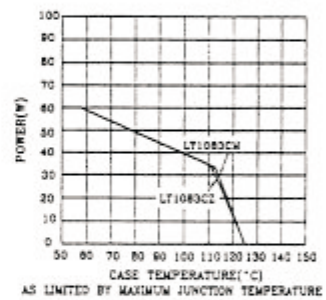

Ripple Rejection

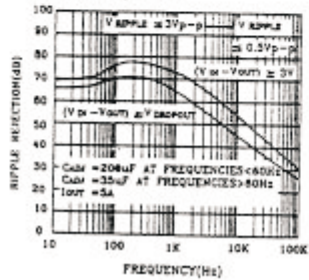

Ripple Rejection vs Current

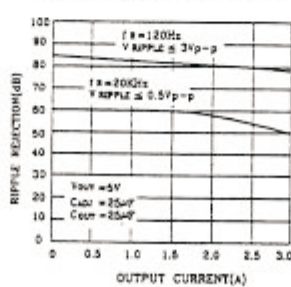

Maximum Power Dissipation

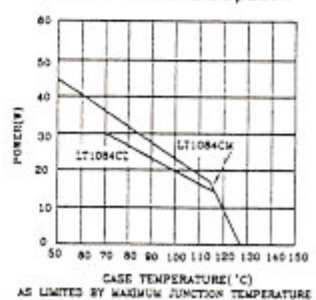

TYPICAL PERFORMANCE CHARACTERISTICS

www.DataSheet4U.com

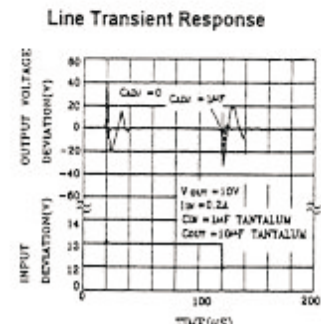
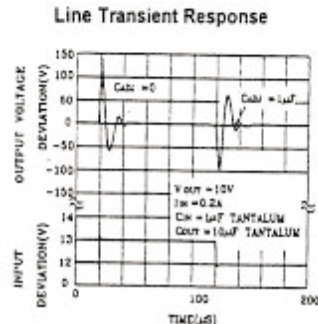
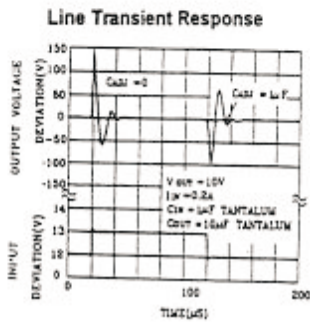
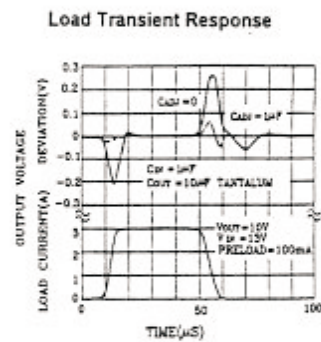
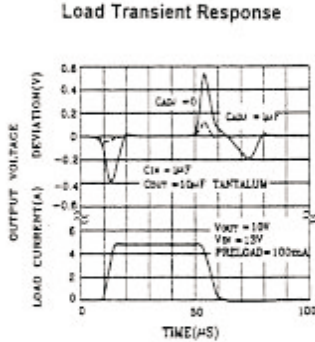
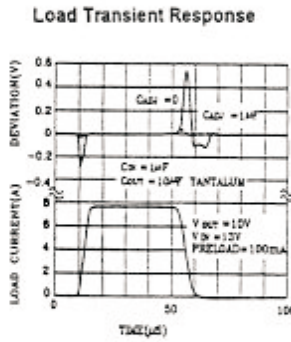
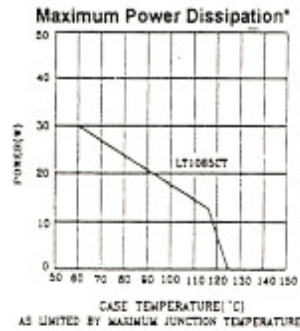
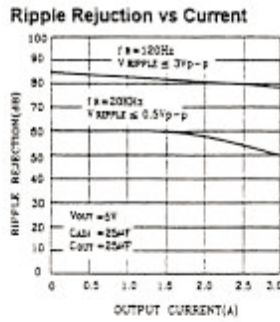
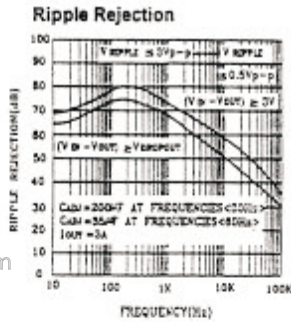

Contek Microelectronics Co.,Ltd.

<http://www.contek-ic.com> E-mail:sales@contek-ic.com