

Optocoupler, Photodarlington Output, High Gain (Dual, Quad Channel)

Features

- Isolation Test Voltage, 5300 V_{RMS}
- High Isolation Resistance, 10¹¹ Ω Typical
- Low Coupling Capacitance
- Standard Plastic DIP Package
- Lead-free component
- Component in accordance to RoHS 2002/95/EC and WEEE 2002/96/EC

Agency Approvals

- UL1577, File No. E52744 System Code H or J, Double Protection
- DIN EN 60747-5-2 (VDE0884)
DIN EN 60747-5-5 pending
Available with Option 1

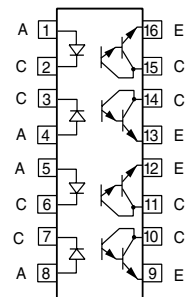
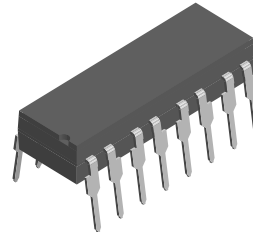
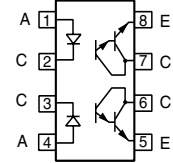
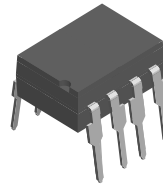

1179017



Description

The ILD32/ ILQ32 are optically coupled isolators with a gallium arsenide infrared LED and a silicon photodarlington sensor. Switching can be achieved while maintaining a high degree of isolation between driving and load circuits.

These optocouplers can be used to replace reed and mercury relays with advantages of long life, high speed switching and elimination of magnetic fields.

Order Information

Part	Remarks
ILD32	CTR > 500 %, DIP-8
ILQ32	CTR > 500 %, DIP-16
ILD32-X006	CTR > 500 %, DIP-8 400 mil (option 6)
ILD32-X007	CTR > 500 %, SMD-8 (option 7)
ILD32-X009	CTR > 500 %, SMD-8 (option 9)
ILQ32-X007	CTR > 500 %, SMD-8 (option 7)
ILQ32-X009	CTR > 500 %, SMD-8 (option 9)

For additional information on the available options refer to Option Information.

Absolute Maximum Ratings

T_{amb} = 25 °C, unless otherwise specified

Stresses in excess of the absolute Maximum Ratings can cause permanent damage to the device. Functional operation of the device is not implied at these or any other conditions in excess of those given in the operational sections of this document. Exposure to absolute Maximum Rating for extended periods of the time can adversely affect reliability.

Input

Parameter	Test condition	Symbol	Value	Unit
Peak reverse voltage		V _R	3.0	V
Forward continuous current		I _F	60	mA
Power dissipation		P _{diss}	100	mW
Derate linearly from 25°C			1.33	mW/°C

Output

Parameter	Test condition	Symbol	Value	Unit
Collector-emitter breakdown voltage		BV_{CEO}	30	V
Collector (load) current		I_C	125	mA
Power dissipation		P_{diss}	150	mW
Derate linearly from 25°C			2.0	mW/°C

Coupler

Parameter	Test condition	Part	Symbol	Value	Unit
Isolation test voltage ¹⁾	$t = 1.0$ sec.		V_{ISO}	5300	V_{RMS}
Creepage				≥ 7	mm
Clearance				≥ 7	mm
Comparative tracking index per DIN IEC 112/VDE303, part 1				≥ 175	
Isolation resistance	$V_{IO} = 500$ V, $T_{amb} = 25$ °C		R_{IO}	10^{12}	Ω
	$V_{IO} = 500$ V, $T_{amb} = 100$ °C		R_{IO}	10^{11}	Ω
Total dissipation		ILD32	P_{tot}	400	mW
		ILQ32	P_{tot}	500	mW
Derate linearly from 25 °C		ILD32		5.33	mW/°C
		ILQ32		6.67	mW/°C
Storage temperature			T_{stg}	- 55 to + 150	°C
Operating temperature			T_{amb}	- 55 to + 100	°C
Lead soldering time at 260 °C				10	sec.

¹⁾ between emitter and detector refer to standard climate 23 °C/50 %RH; DIN 50014

Electrical Characteristics

$T_{amb} = 25$ °C, unless otherwise specified

Minimum and maximum values are testing requirements. Typical values are characteristics of the device and are the result of engineering evaluation. Typical values are for information only and are not part of the testing requirements.

Input

Parameter	Test condition	Symbol	Min	Typ.	Max	Unit
Forward voltage	$I_F = 10$ mA	V_F		1.25	1.5	V
Reverse current	$V_R = 3.0$ V	I_R		0.1	100	pF
Capacitance	$V_R = 0$ V	C_O		25		pF

Output

Parameter	Test condition	Symbol	Min	Typ.	Max	Unit
Collector-emitter breakdown voltage	$I_C = 100$ μ A, $I_F = 0$	BV_{CEO}	30			V
Breakdown voltage emitter-collector	$I_E = 100$ μ A	BC_{ECO}	5.0	10		nA
Collector-emitter leakage current	$V_{CE} = 10$ V, $I_F = 0$	I_{CEO}		1.0	100	nA

Coupler

Parameter	Test condition	Symbol	Min	Typ.	Max	Unit
Collector emitter	$I_C = 2.0 \text{ mA}$, $I_F = 8.0 \text{ mA}$	V_{CEsat}			1.0	V
Capacitance (input-output)		C_{IO}		0.5		pF

Current Transfer Ratio

Parameter	Test condition	Symbol	Min	Typ.	Max	Unit
Current Transfer Ratio	$I_F = 10 \text{ mA}$, $V_{CE} = 10 \text{ V}$	CTR	500			%

Switching Characteristics

Parameter	Test condition	Symbol	Min	Typ.	Max	Unit
Turn-on time	$V_{CC} = 10 \text{ V}$, $I_F = 5.0 \text{ mA}$, $R_L = 100 \ \Omega$	t_{on}		15		μs
Turn-off time	$V_{CC} = 10 \text{ V}$, $I_F = 5.0 \text{ mA}$, $R_L = 100 \ \Omega$	t_{off}		30		μs

Typical Characteristics ($T_{amb} = 25 \text{ }^\circ\text{C}$ unless otherwise specified)

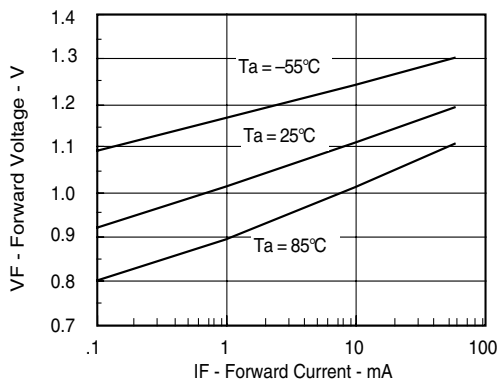

ild32_01

Figure 1. Forward Voltage vs. Forward Current

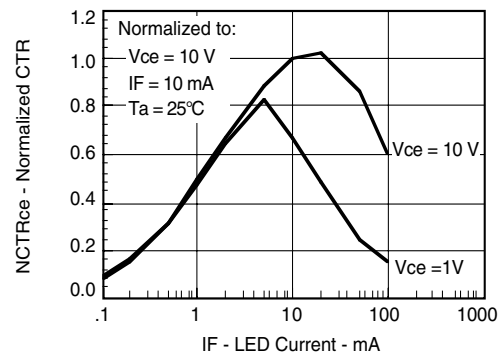

ild32_02

Figure 2. Normalized Non-saturated and Saturated CTR_{CE} vs. LED Current

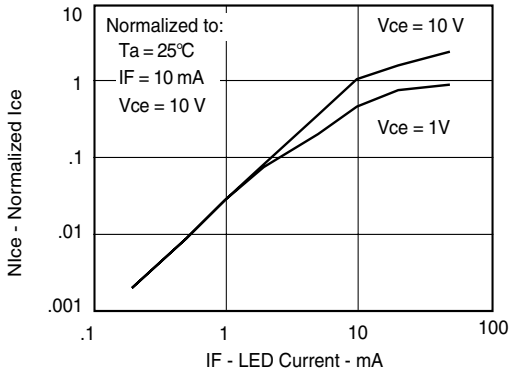

Figure 3. Normalized Non-Saturated and Saturated Collector-Emitter Current vs. LED Current

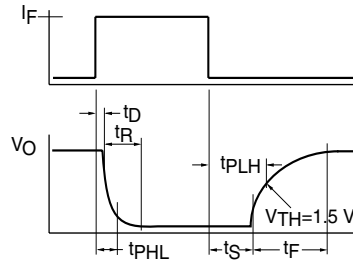

Figure 6. Switching Timing

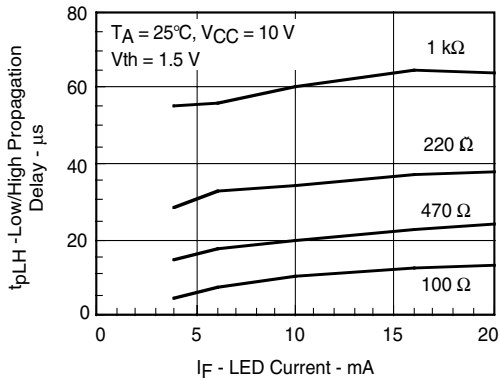

Figure 4. Low to High Propagation Delay vs. Collector Load Resistance and LED Current

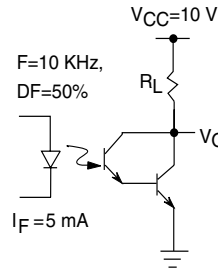

Figure 7. Switching Schematic

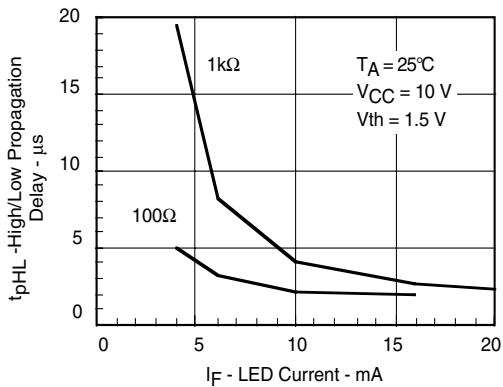
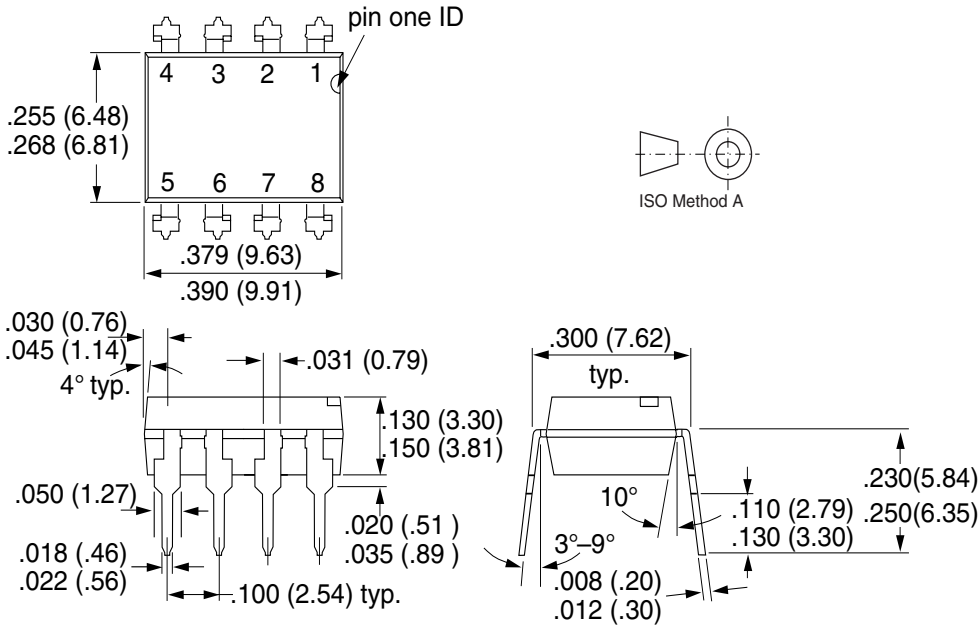
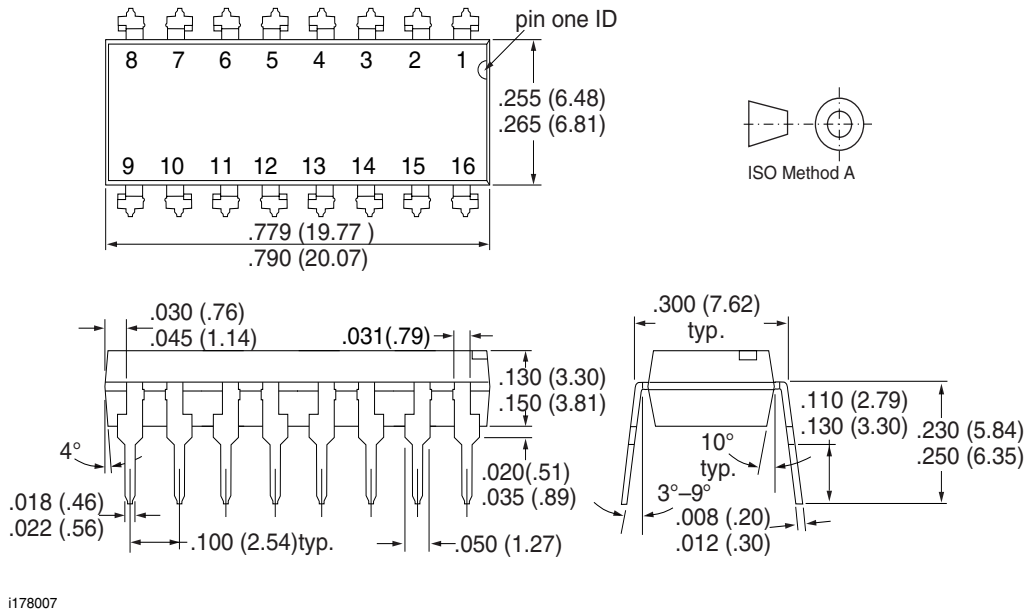

Figure 5. High to low Propagation Delay vs. Collector Load Resistance and LED Current

Package Dimensions in Inches (mm)



Package Dimensions in Inches (mm)



Option 6

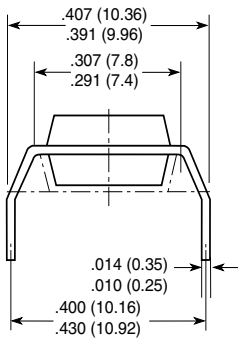

Option 7

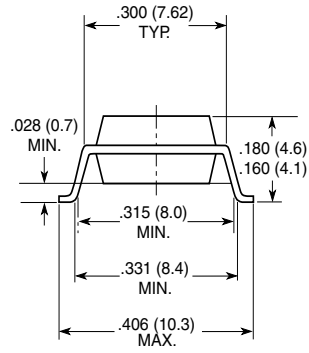

Option 9

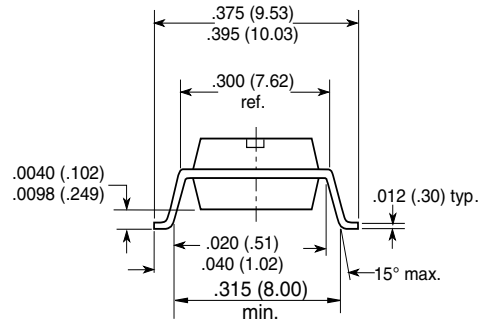

18450



Ozone Depleting Substances Policy Statement

It is the policy of Vishay Semiconductor GmbH to

1. Meet all present and future national and international statutory requirements.
2. Regularly and continuously improve the performance of our products, processes, distribution and operating systems with respect to their impact on the health and safety of our employees and the public, as well as their impact on the environment.

It is particular concern to control or eliminate releases of those substances into the atmosphere which are known as ozone depleting substances (ODSs).

The Montreal Protocol (1987) and its London Amendments (1990) intend to severely restrict the use of ODSs and forbid their use within the next ten years. Various national and international initiatives are pressing for an earlier ban on these substances.

Vishay Semiconductor GmbH has been able to use its policy of continuous improvements to eliminate the use of ODSs listed in the following documents.

1. Annex A, B and list of transitional substances of the Montreal Protocol and the London Amendments respectively
2. Class I and II ozone depleting substances in the Clean Air Act Amendments of 1990 by the Environmental Protection Agency (EPA) in the USA
3. Council Decision 88/540/EEC and 91/690/EEC Annex A, B and C (transitional substances) respectively.

Vishay Semiconductor GmbH can certify that our semiconductors are not manufactured with ozone depleting substances and do not contain such substances.

We reserve the right to make changes to improve technical design and may do so without further notice.

Parameters can vary in different applications. All operating parameters must be validated for each customer application by the customer. Should the buyer use Vishay Semiconductors products for any unintended or unauthorized application, the buyer shall indemnify Vishay Semiconductors against all claims, costs, damages, and expenses, arising out of, directly or indirectly, any claim of personal damage, injury or death associated with such unintended or unauthorized use.

Vishay Semiconductor GmbH, P.O.B. 3535, D-74025 Heilbronn, Germany
Telephone: 49 (0)7131 67 2831, Fax number: 49 (0)7131 67 2423



Notice

Specifications of the products displayed herein are subject to change without notice. Vishay Intertechnology, Inc., or anyone on its behalf, assumes no responsibility or liability for any errors or inaccuracies.

Information contained herein is intended to provide a product description only. No license, express or implied, by estoppel or otherwise, to any intellectual property rights is granted by this document. Except as provided in Vishay's terms and conditions of sale for such products, Vishay assumes no liability whatsoever, and disclaims any express or implied warranty, relating to sale and/or use of Vishay products including liability or warranties relating to fitness for a particular purpose, merchantability, or infringement of any patent, copyright, or other intellectual property right.

The products shown herein are not designed for use in medical, life-saving, or life-sustaining applications. Customers using or selling these products for use in such applications do so at their own risk and agree to fully indemnify Vishay for any damages resulting from such improper use or sale.