

**MECHANICAL DATA**

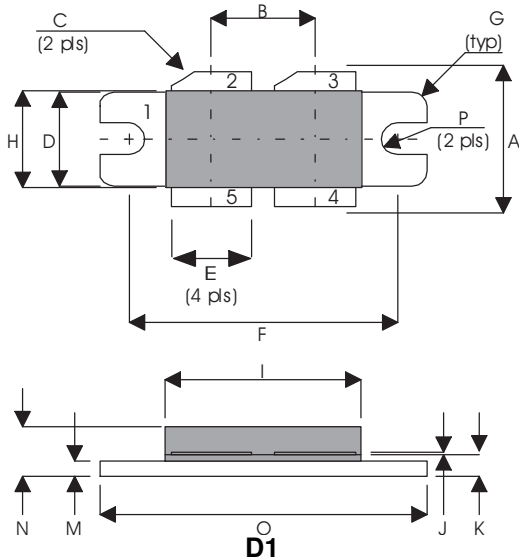

PIN 1 SOURCE (COMMON)      PIN 2 DRAIN 1  
 PIN 3 DRAIN 2              PIN 4 GATE 2  
 PIN 5 GATE 1

DIM	Millimetres	Tol.	Inches	Tol.
A	15.24	0.50	0.600	0.020
B	10.80	0.13	0.425	0.005
C	45°	5°	45°	5°
D	9.78	0.13	0.385	0.005
E	8.38	0.13	0.330	0.005
F	27.94	0.13	1.100	0.005
G	1.52R	0.13	0.060R	0.005
H	10.16	0.15	0.400	0.006
I	21.84	0.23	0.860	0.009
J	0.10	0.02	0.004	0.001
K	1.96	0.13	0.077	0.005
M	1.02	0.13	0.040	0.005
N	4.45	0.38	0.175	0.015
O	34.04	0.13	1.340	0.005
P	1.63R	0.13	0.064R	0.005

**GOLD METALLISED**  
**MULTI-PURPOSE SILICON**  
**DMOS RF FET**  
**350W – 28V – 175MHz**  
**PUSH-PULL**

**FEATURES**

- SUITABLE FOR BROAD BAND APPLICATIONS
- SIMPLE BIAS CIRCUITS
- ULTRA-LOW THERMAL RESISTANCE
- BeO FREE
- LOW Crss
- HIGH GAIN – 16 dB MINIMUM

**APPLICATIONS**

- VHF/UHF COMMUNICATIONS  
from 1 MHz to 400 MHz

**ABSOLUTE MAXIMUM RATINGS** ( $T_{case} = 25^{\circ}C$  unless otherwise stated)

$P_D$	Power Dissipation	875W (438W -A Version)
$BV_{DSS}$	Drain – Source Breakdown Voltage *	70V
$BV_{GSS}$	Gate – Source Breakdown Voltage*	$\pm 20V$
$I_{D(sat)}$	Drain Current*	35A
$T_{stg}$	Storage Temperature	-65 to 150°C
$T_j$	Maximum Operating Junction Temperature	200°C

\* Per Side

Semelab Plc reserves the right to change test conditions, parameter limits and package dimensions without notice. Information furnished by Semelab is believed to be both accurate and reliable at the time of going to press. However Semelab assumes no responsibility for any errors or omissions discovered in its use. Semelab encourages customers to verify that datasheets are current before placing orders.

### ELECTRICAL CHARACTERISTICS ( $T_{case} = 25^{\circ}C$ unless otherwise stated)

Parameter	Test Conditions	Min.	Typ.	Max.	Unit	
<b>PER SIDE</b>						
$BV_{DSS}$	Drain-Source Breakdown Voltage	$V_{GS} = 0$	$I_D = 100mA$	70		V
$I_{DSS}$	Zero Gate Voltage Drain Current	$V_{DS} = 28V$	$V_{GS} = 0$		7	mA
$I_{GSS}$	Gate Leakage Current	$V_{GS} = 20V$	$V_{DS} = 0$		7	$\mu A$
$V_{GS(th)}$	Gate Threshold Voltage*	$I_D = 10mA$	$V_{DS} = V_{GS}$	1	7	V
$g_{fs}$	Forward Transconductance*	$V_{DS} = 10V$	$I_D = 6A$	5.6		mhos
$V_{GS(th)match}$	Gate Threshold Voltage Matching Between Sides	$I_D = 10mA$	$V_{DS} = V_{GS}$		0.1	V
<b>TOTAL DEVICE</b>						
$G_{PS}$	Common Source Power Gain	$P_O = 350W$		16		dB
$\eta$	Drain Efficiency	$V_{DS} = 28V$	$I_{DQ} = 2A$	60		%
VSWR	Load Mismatch Tolerance	$f = 175MHz$		20:1		—
<b>PER SIDE</b>						
$C_{iss}$	Input Capacitance	$V_{DS} = 28V$	$V_{GS} = -5V$	$f = 1MHz$	420	pF
$C_{oss}$	Output Capacitance	$V_{DS} = 28V$	$V_{GS} = 0$	$f = 1MHz$	210	pF
$C_{rss}$	Reverse Transfer Capacitance	$V_{DS} = 28V$	$V_{GS} = 0$	$f = 1MHz$	17.5	pF

\* Pulse Test: Pulse Duration = 300  $\mu s$  , Duty Cycle  $\leq 2\%$

### THERMAL DATA

$R_{THj-case}$	Thermal Resistance Junction – Case	Max. 0.2 $^{\circ}C/W$ 0.4 $^{\circ}C/W$ -A Version
----------------	------------------------------------	--

Semelab Plc reserves the right to change test conditions, parameter limits and package dimensions without notice. Information furnished by Semelab is believed to be both accurate and reliable at the time of going to press. However Semelab assumes no responsibility for any errors or omissions discovered in its use. Semelab encourages customers to verify that datasheets are current before placing orders.

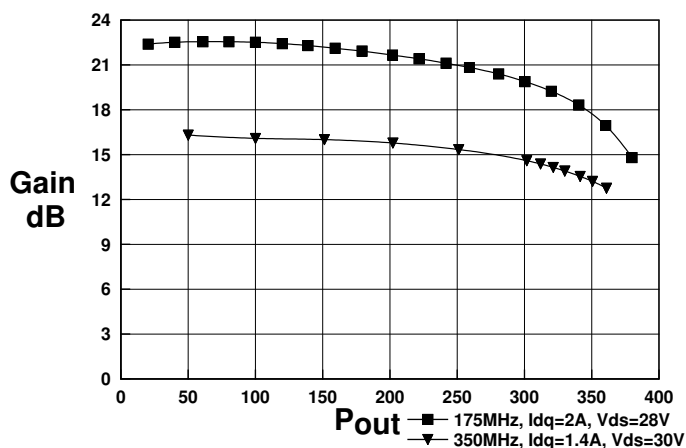

Figure 1 – Gain vs. Power Output.

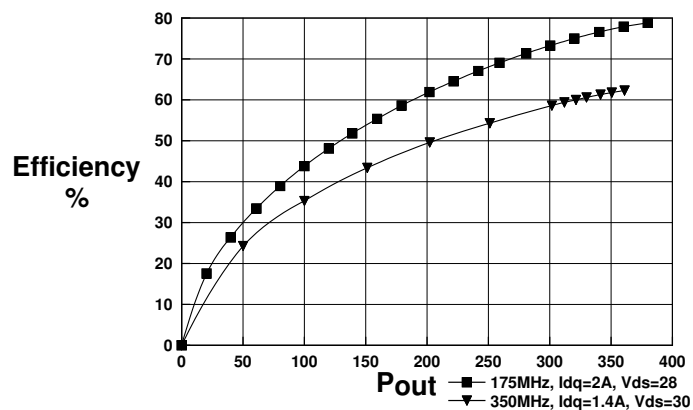

Figure 2 – Efficiency vs. Power Output.

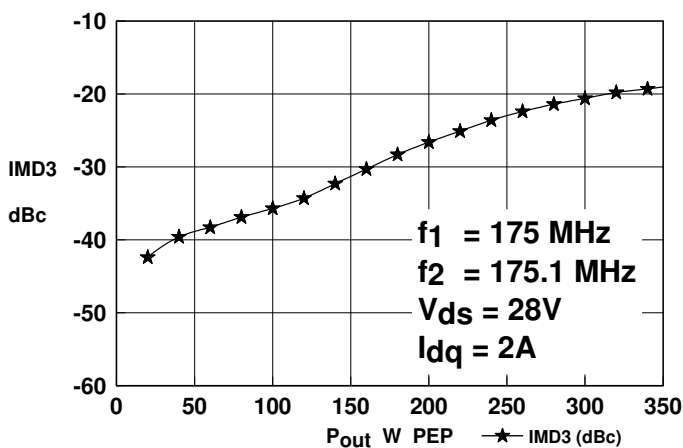

Figure 3 – IMD vs. Power Output

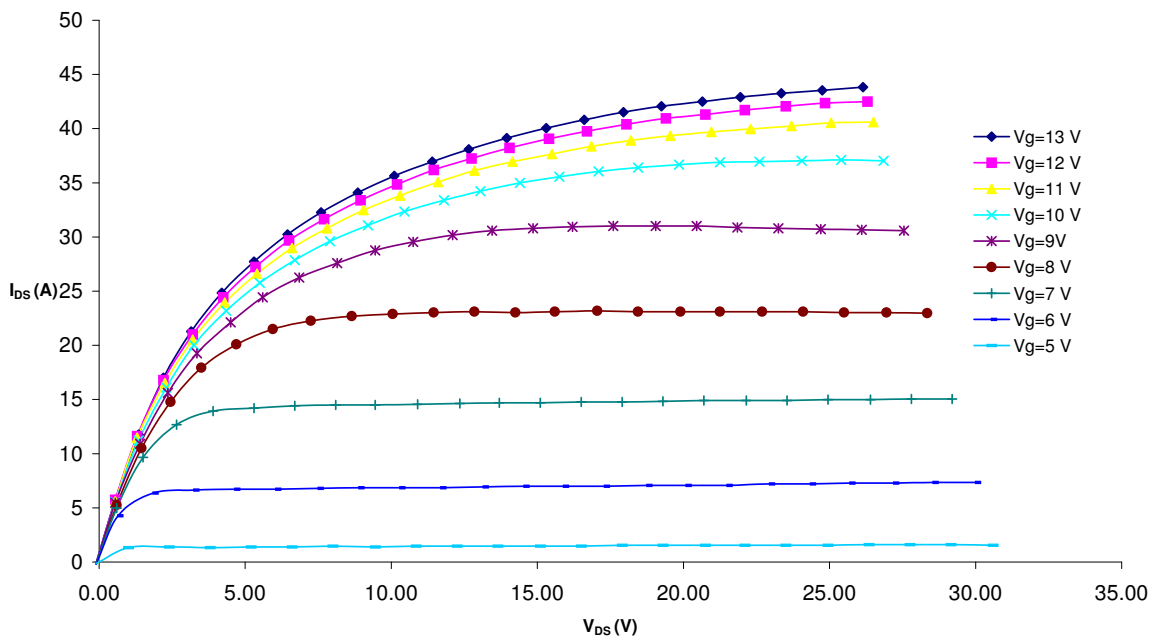

Figure 4 – Typical IV Characteristics.

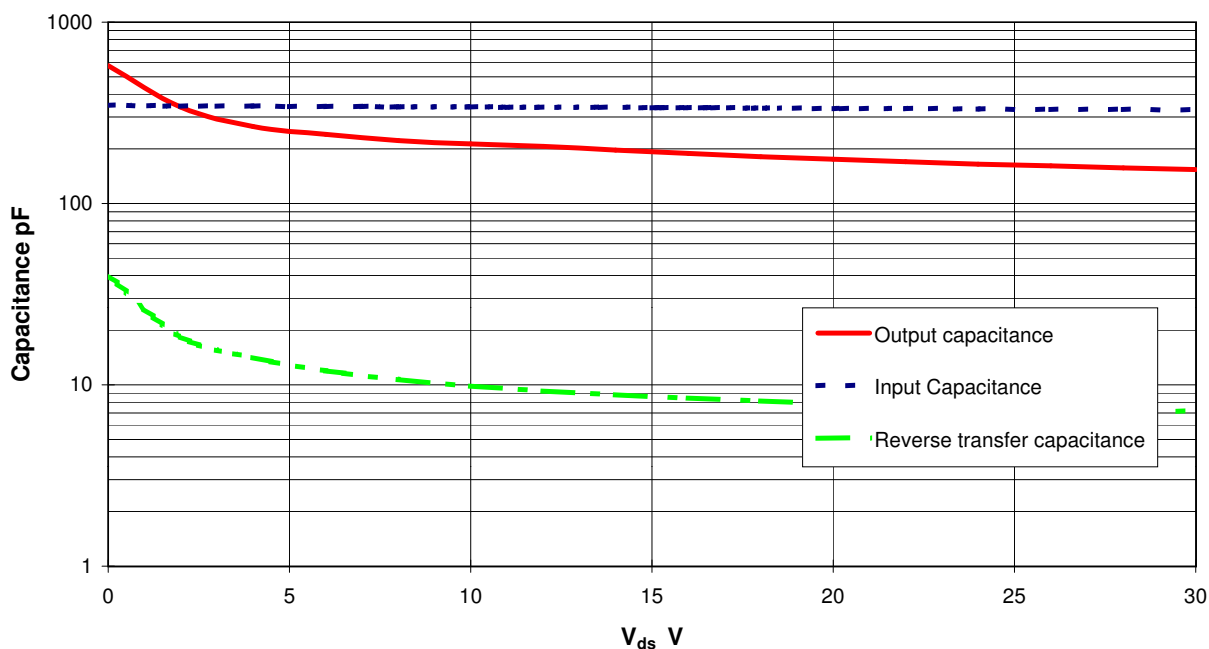
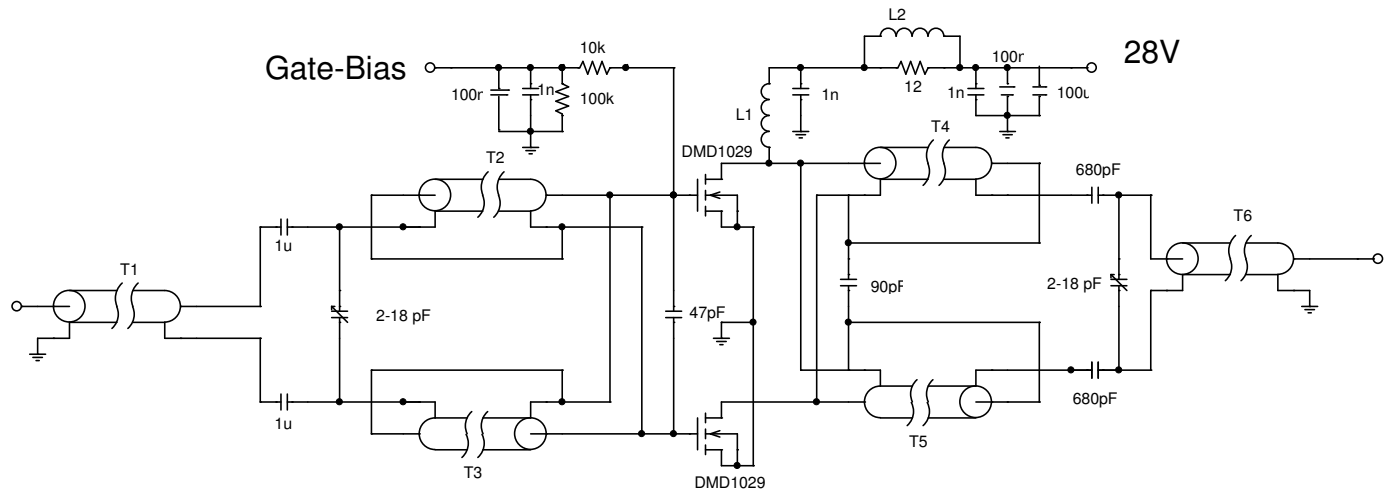

Figure 5 – Typical CV Characteristics.

Semelab Plc reserves the right to change test conditions, parameter limits and package dimensions without notice. Information furnished by Semelab is believed to be both accurate and reliable at the time of going to press. However Semelab assumes no responsibility for any errors or omissions discovered in its use. Semelab encourages customers to verify that datasheets are current before placing orders.



## DMD1029 175MHz TEST JIG

- T1 7cm RG316 coax on Siemens A1 x 1 2 hole core
- T2,3 7cm RG316 coax on Siemens A1 x 1 2 hole core
- T4,5 14cm RG316 coax
- T6 11cm RG316 coax
- L2 1.5 turns 1mm dia wire on Siemens A1 x 1 2 hole core
- L1 8.5 turns 1mm dia wire, 4mm internal diameter