

PLEASE CHECK WWW.MOLEX.COM FOR LATEST PART INFORMATION

Part Number: [0355191603](#)
Status: **Active**
Description: 2.29/6.35mm (.090/.250") Tab Hybrid Wire-to-Wire Housing, Female, 16 Circuits

Documents:

[Drawing \(PDF\)](#) [RoHS Certificate of Compliance \(PDF\)](#)
[Product Specification PS-35519-001 \(PDF\)](#)

General

Product Family	Crimp Housings
Series	35519
Comments	With option #4 polarization
Product Name	N/A

Physical

Circuits (maximum)	16
Color - Resin	Yellow
Gender	Female
Glow-Wire Compliant	No
Material - Resin	Polyester
Number of Rows	3
Packaging Type	Bag
Panel Mount	No
Pitch - Mating Interface (in)	0.165 In, 0.374 In
Pitch - Mating Interface (mm)	4.20 mm, 9.50 mm
Temperature Range - Operating	-40°C to +120°C

Material Info

Reference - Drawing Numbers

Product Specification	PS-35519-001
Sales Drawing	SD-35519-160*

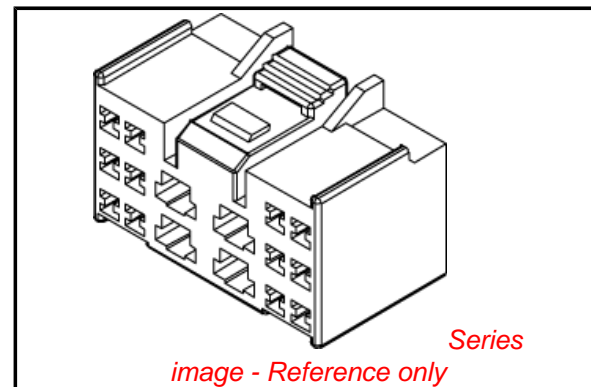

EU RoHS

**ELV and RoHS
Compliant**
REACH SVHC
 Not Reviewed
**Halogen-Free
Status**

China RoHS



**Need more information on product
environmental compliance?**

Email productcompliance@molex.com
 For a multiple part number RoHS Certificate of Compliance, [click here](#)

Please visit the [Contact Us](#) section for any non-product compliance questions.

Search Parts in this Series

[35519Series](#)

Mates With

[35522|35523](#)

Use With

[35407](#) , [35427](#)

PLEASE CHECK WWW.MOLEX.COM FOR LATEST PART INFORMATION

DWG. NO. SD 35519-160*
 PROJECT NO. KOR 96-038
 SIMILAR ITEM
 DO NOT SCALE DRAWING DIMENSION IN METRIC

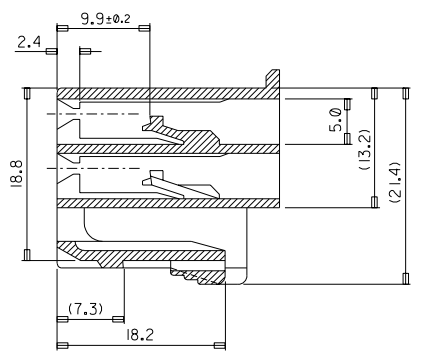

SECTION B-B'

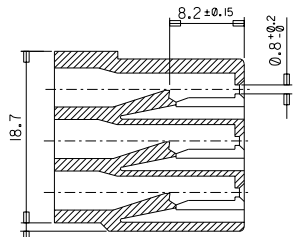

SECTION A-A'

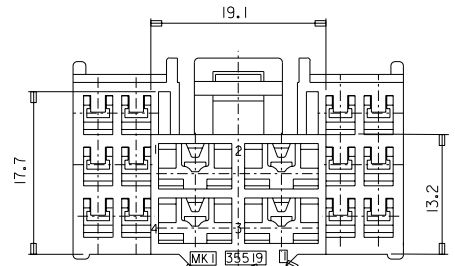
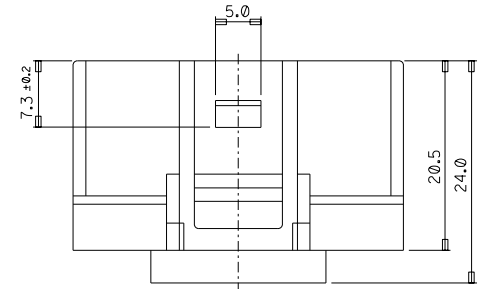
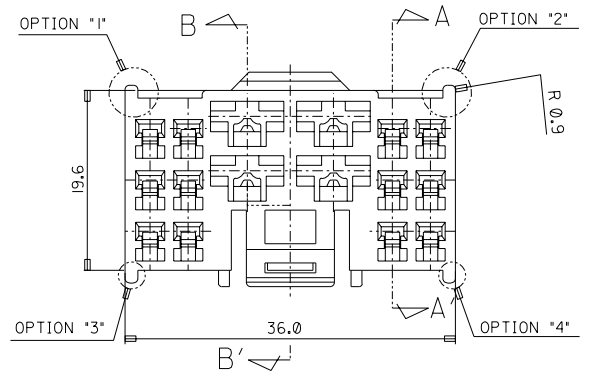

*TABLE 1

PART NO.	COLOR	REMARKS
E 35519-1600	NATERAL	WITH OPTION "2"
E 35519-1601	BLACK	WITH OPTION "1"
E 35519-1603	YELLOW	WITH OPTION "4"
E 35519-1605	GRAY	WITH OPTION "3"

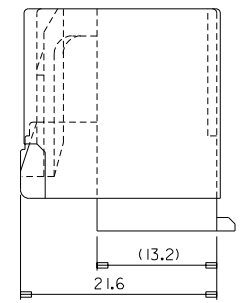

- NOTE
- MATERIAL : POLYESTER (P.B.T)
 - COLOR : SEE TABLE 1.
 - APPLICABLE TERMINAL : 35407-6*02/
35427-9***
 - APPLICABLE HOUSING : 35522-240*/35523-160*.
 - PRODUCT SPECIFICATION : PS-35519-0001.

REVISED EC NO. KOR 1998-0116 DRAWN: C.Y.CHO CHK: B.K.CHOI APPR: C.W.LEE	DESCRIPTION MAJOR CRITICAL C	QUALITY SYMBOLS	GENERAL TOLERANCES: (UNLESS SPECIFIED) <table border="1"> <tr> <td></td> <td>mm</td> <td>INCH</td> </tr> <tr> <td>4 PLACES</td> <td>±0.</td> <td>±.</td> </tr> <tr> <td>3 PLACES</td> <td>±0.</td> <td>±.</td> </tr> <tr> <td>2 PLACES</td> <td>±0.20</td> <td>±.</td> </tr> <tr> <td>1 PLACE</td> <td>±0.30</td> <td>±.</td> </tr> </table>		mm	INCH	4 PLACES	±0.	±.	3 PLACES	±0.	±.	2 PLACES	±0.20	±.	1 PLACE	±0.30	±.	SCALE <input checked="" type="checkbox"/> mm <input type="checkbox"/> INCH	DESIGN UNITS <input checked="" type="checkbox"/> mm <input type="checkbox"/> INCH	THIRD ANGLE PROJECTION <input checked="" type="checkbox"/> THIRD ANGLE <input type="checkbox"/> FIRST ANGLE	DIMENSIONS: <input type="checkbox"/> mm <input type="checkbox"/> INCH <input checked="" type="checkbox"/> mm ONLY	SHT REV
					mm	INCH																	
4 PLACES	±0.	±.																					
3 PLACES	±0.	±.																					
2 PLACES	±0.20	±.																					
1 PLACE	±0.30	±.																					
DRAWN BY & DATE C.Y.CHO 1998.05.15	TITLE: 090/250 HYBRID FEMALE HOUSING (16P)		CHECKED BY & DATE B.K.CHOI 1998.05.15		APPROVED BY & DATE C.W.LEE 1998.05.15		MOLEX INCORPORATED KOREA																
B	REV		ANGULAR: ± 1° DRAFT WHERE APPLICABLE MUST REMAIN WITHIN DIMENSIONS	CAD FILENAME SD35519.DGN	MATERIAL NO. SD 35519-160*	DRAWING NO. SD 35519-160*	SHEET NO. 1/1																
THIS DRAWING CONTAINS INFORMATION THAT IS PROPRIETARY TO MOLEX INCORPORATED AND SHOULD NOT BE USED WITHOUT WRITTEN PERMISSION.							SIZE B																