

**PLEASE CHECK WWW.MOLEX.COM FOR LATEST PART INFORMATION**

**Part Number:** [0767639001](#)  
**Status:** **Active**  
**Overview:** [vhdm\\_h](#)  
**Description:** 2.00mm (.079") Pitch VHDM® H Board-to-Board Backplane Header, Vertical, 6-Row, Open End Module, Open Ends Version, 150 Circuits, Pin Length 4.75mm (.187"), Lead Free

**Documents:**

[Drawing \(PDF\)](#) [RoHS Certificate of Compliance \(PDF\)](#)  
[Product Specification PS-74031-999 \(PDF\)](#)

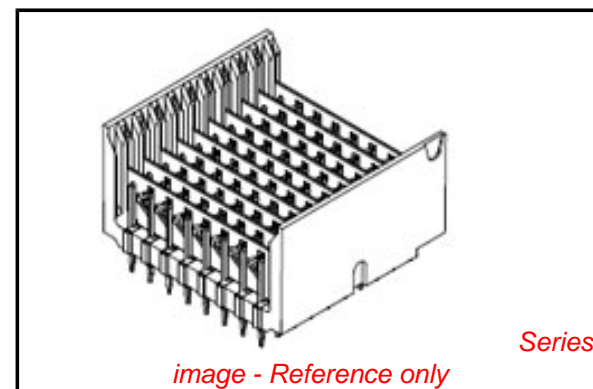

**General**

Product Family	Backplane Connectors
Series	<a href="#">76763</a>
Application	Backplane
Comments	No Keying Position
Component Type	PCB Header
Overview	<a href="#">vhdm_h</a>
Product Name	VHDM® - H Series
Style	N/A

**Physical**

Circuits (Loaded)	60
Circuits (maximum)	60
Color - Resin	Black
Durability (mating cycles max)	200
First Mate / Last Break	No
Guide to Mating Part	No
Keying to Mating Part	None
Material - Metal	Copper Alloy
Material - Plating Mating	Gold
Material - Plating Termination	Tin
Material - Resin	High Temperature Thermoplastic
Number of Columns	10
Number of Pairs	Open Pin Field
Number of Rows	6
Orientation	Vertical
PC Tail Length (in)	0.072 In
PC Tail Length (mm)	1.83 mm
PCB Locator	No
PCB Retention	None
PCB Thickness Recommended (in)	0.072 In
PCB Thickness Recommended (mm)	1.83 mm
Packaging Type	Tube
Pitch - Mating Interface (in)	0.079 In
Pitch - Mating Interface (mm)	2.00 mm
Pitch - Term. Interface (in)	0.089 In
Pitch - Term. Interface (mm)	2.25 mm
Plating min: Mating (µin)	30
Plating min: Mating (µm)	0.75
Plating min: Termination (µin)	30
Plating min: Termination (µm)	0.75
Polarized to PCB	Yes
Stackable	No
Surface Mount Compatible (SMC)	Yes
Temperature Range - Operating	-55°C to +85°C

**EU RoHS**

**ELV and RoHS Compliant**  
**REACH SVHC**  
 Not Reviewed  
**Halogen-Free Status**  
 Not Reviewed

**China RoHS**



**Need more information on product environmental compliance?**

Email [productcompliance@molex.com](mailto:productcompliance@molex.com)  
 For a multiple part number RoHS Certificate of Compliance, [click here](#)

Please visit the [Contact Us](#) section for any non-product compliance questions.

**Search Parts in this Series**

[76763Series](#)

**Application Tooling | FAQ**

*Tooling specifications and manuals are found by selecting the products below. Crimp Height Specifications are then contained in the Application Tooling Specification document.*

**Global**

Description	Product #
VHDM® Signal Pin	<a href="#">0622015700</a>
Inserter Repair Tool	
VHDM® 6 Row Pin and Shield Repair Tool	<a href="#">0622015800</a>
VHDM® 6 Row Shield Extraction Tool	<a href="#">0622016000</a>
VHDM® Insertion Module for Advanced Mate Signal Header, 6 Row by 10 Wide, 20.00mm (.787")	<a href="#">0622020207</a>

Termination Interface: Style

Through Hole - Compliant Pin

**Electrical**

Current - Maximum per Contact

1A

Data Rate

6.25 Gbps

Real Signals (per 25mm)

75

Shield Type

Ground Plane Shield

Shielded

Yes

Voltage - Maximum

120V AC (RMS)/DC

**Material Info**

**Reference - Drawing Numbers**

Packaging Specification

PK-74057-003

Product Specification

PS-74031-999

Sales Drawing

SD-76763-001

VHDM and Very High Density Metric are trademarks of Amphenol Corporation

This document was generated on 05/20/2010

**PLEASE CHECK [WWW.MOLEX.COM](http://WWW.MOLEX.COM) FOR LATEST PART INFORMATION**

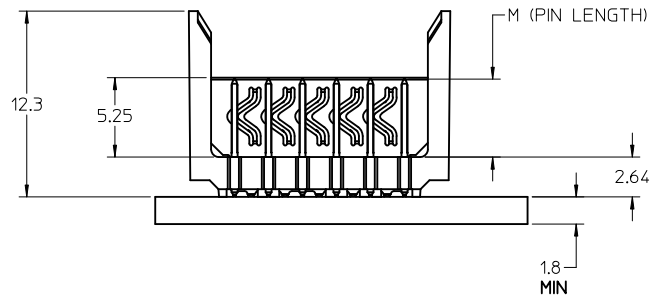
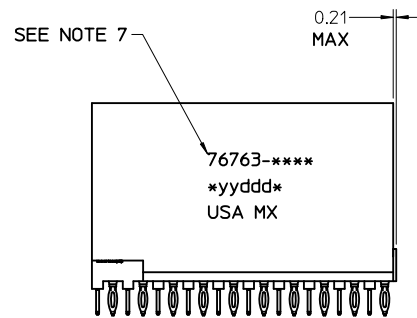
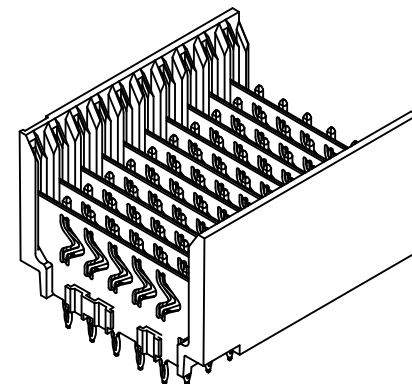
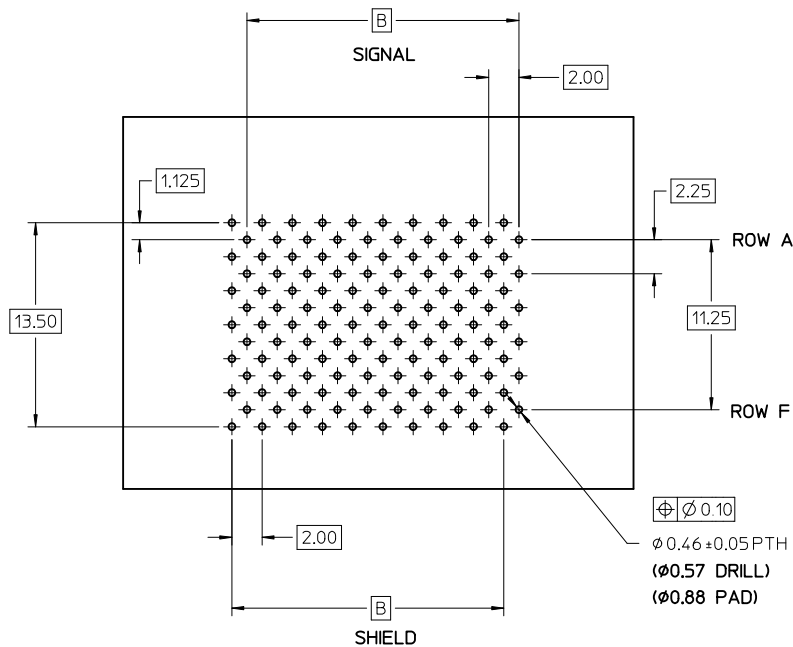
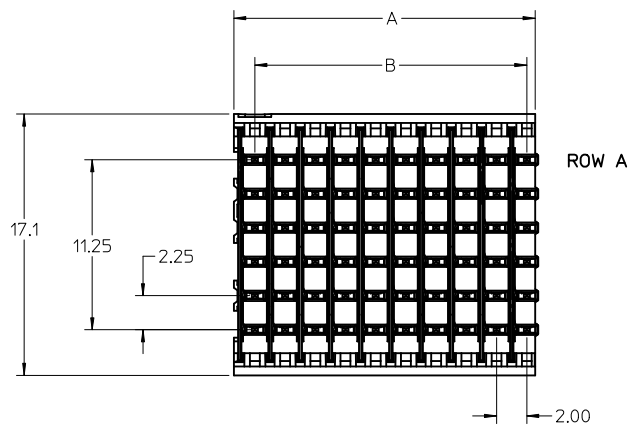

- NOTES:**
- MATERIALS:**  
HOUSING - LIQUID CRYSTAL POLYMER (LCP)  
GLASS FILLED, UL94V-0, BLACK  
SIGNAL PIN AND SHIELD - COPPER ALLOY
  - FINISHES:**  
CONTACT AREA - SELECTIVE GOLD (Au)  
PCB TAILS - SELECTIVE TIN/LEAD (SnPb) OR MATTE TIN (Sn)
3. THIS PART CONFORMS TO MOLEX PRODUCT SPECIFICATION PS-74031-999.
- FOR MIXED CONTACT LENGTH CONTACT MOLEX FOR AVAILABILITY.
  - FOR SPECIFIC MATERIAL NUMBERS AND MATING INFORMATION REFER TO SHEET 2.
  - PACKAGE PER PK-74057-003.
  - ASSEMBLY WILL BE MARKED WITH P/N AND DATE CODE WITH LASER MARK ON SIDE OF HOUSING OR BY LABEL ON THE TUBE.

SEE SHEET 2 EC NO: UCP2010-1510 DRWN: JONI AK 2010/03/05 CHKD: JMLTON 2010/03/09 APPR: SMILLER 2010/03/09	QUALITY SYMBOLS 	GENERAL TOLERANCES (UNLESS SPECIFIED)		DIMENSION STYLE <b>MM ONLY</b>		SCALE 2:1	DESIGN UNITS METRIC	THIRD ANGLE PROJECTION			
		4 PLACES ± --- ± ---	3 PLACES ± --- ± ---	2 PLACES ± 0.15 ± ---	1 PLACE ± 0.25 ± ---	DRAWN BY JONI AK	DATE 2008/07/09	TITLE <b>VHDM H-SERIES 6 ROW OPEN END BACKPLANE</b>			
		ANGULAR ±1/2°		DRAFT WHERE APPLICABLE MUST REMAIN WITHIN DIMENSIONS		CHECKED BY JONI AK	DATE 2008/07/09				
		SIZE C		SEE SHEET 2		APPROVED BY SMILLER	DATE 2010/03/09	MOLEX INCORPORATED		MATERIAL NO. DOCUMENT NO. SD-76763-001	
				THIS DRAWING CONTAINS INFORMATION THAT IS PROPRIETARY TO MOLEX INCORPORATED AND SHOULD NOT BE USED WITHOUT WRITTEN PERMISSION		SHEET NO. 1 OF 2					

PART NUMBER	COLUMN	NUMBER OF SIGNAL PIN	NUMBER OF SHIELD	A	B	M	Au (um) THICKNESS
76763-1001	10	60	10	20.00	18.00	4.75	0.76
76763-1006							1.27
76763-1501	15	90	15	30.00	28.00		0.76
76763-1506							1.27
76763-2501	25	150	25	50.00	48.00	0.76	
76763-2506						1.27	
76763-1002	10	60	10	20.00	18.00	0.76	
76763-1007						1.27	
76763-1502	15	90	15	30.00	28.00	0.76	
76763-1507						1.27	
76763-2502	25	150	25	50.00	48.00	0.76	
76763-2507						1.27	
76763-1003	10	60	10	20.00	18.00	0.76	
76763-1008						1.27	
76763-1503	15	90	15	30.00	28.00	0.76	
76763-1508						1.27	
76763-2503	25	150	25	50.00	48.00	0.76	
76763-2508						1.27	
76763-1004	10	60	10	20.00	18.00	0.76	
76763-1009						1.27	
76763-1504	15	90	15	30.00	28.00	0.76	
76763-1509						1.27	
76763-2504	25	150	25	50.00	48.00	0.76	
76763-2509						1.27	

TIN/LEAD TABLE

PART NUMBER	COLUMN	NUMBER OF SIGNAL PIN	NUMBER OF SHIELD	A	B	M	Au (um) THICKNESS
76763-9001	10	60	10	20.00	18.00	4.75	0.76
76763-9006							1.27
76763-9501	15	90	15	30.00	28.00		0.76
76763-9506							1.27
76763-8501	25	150	25	50.00	48.00	0.76	
76763-8506						1.27	
76763-9002	10	60	10	20.00	18.00	0.76	
76763-9007						1.27	
76763-9502	15	90	15	30.00	28.00	0.76	
76763-9507						1.27	
76763-8502	25	150	25	50.00	48.00	0.76	
76763-8507						1.27	
76763-9003	10	60	10	20.00	18.00	0.76	
76763-9008						1.27	
76763-9503	15	90	15	30.00	28.00	0.76	
76763-9508						1.27	
76763-8503	25	150	25	50.00	48.00	0.76	
76763-8508						1.27	
76763-9004	10	60	10	20.00	18.00	0.76	
76763-9009						1.27	
76763-9504	15	90	15	30.00	28.00	0.76	
76763-9509						1.27	
76763-8504	25	150	25	50.00	48.00	0.76	
76763-8509						1.27	

LEAD FREE TABLE

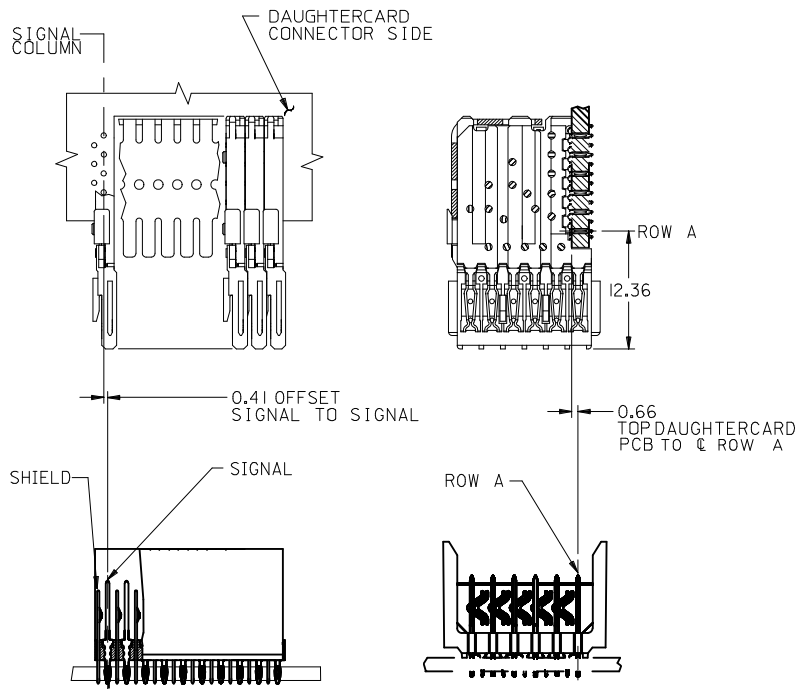

MATERIAL NUMBER ASSIGNMENT

76763-\*\* \*\* SEE TABLES

- NUMBER OF COLUMNS/PLATING
- 10 = 10 COLUMN TIN/LEAD
- 15 = 15 COLUMN TIN/LEAD
- 25 = 25 COLUMN TIN/LEAD
- 90 = 10 COLUMN MATTE TIN
- 95 = 15 COLUMN MATTE TIN
- 85 = 25 COLUMN MATTE TIN

<b>CORRECT P/Ns IN TABLES</b> EC NO: UCP2010-1510 DRWN: JONIAK 2010/03/05 CHKD: JMLTON 2010/03/09 APPR: SMILLER 2010/03/09	QUALITY SYMBOLS ▽=0 ▽=0 ▽=0	GENERAL TOLERANCES (UNLESS SPECIFIED) <table border="1"> <tr><th colspan="2">mm</th><th colspan="2">INCH</th></tr> <tr><td>4 PLACES</td><td>± ---</td><td>± ---</td><td>± ---</td></tr> <tr><td>3 PLACES</td><td>± ---</td><td>± ---</td><td>± ---</td></tr> <tr><td>2 PLACES</td><td>± 0.15</td><td>± ---</td><td>± ---</td></tr> <tr><td>1 PLACE</td><td>± 0.25</td><td>± ---</td><td>± ---</td></tr> </table>	mm		INCH		4 PLACES	± ---	± ---	± ---	3 PLACES	± ---	± ---	± ---	2 PLACES	± 0.15	± ---	± ---	1 PLACE	± 0.25	± ---	± ---	DIMENSION STYLE <b>MM ONLY</b> DRAWN BY DATE JONIAK 2008/07/09 CHECKED BY DATE JONIAK 2008/07/09 APPROVED BY DATE SMILLER 2010/03/09	SCALE <b>1:1</b> DESIGN UNITS <b>METRIC</b> THIRD ANGLE PROJECTION	TITLE <b>VHDM H-SERIES          6 ROW OPEN END BACKPLANE</b>
	mm		INCH																						
	4 PLACES	± ---	± ---	± ---																					
	3 PLACES	± ---	± ---	± ---																					
2 PLACES	± 0.15	± ---	± ---																						
1 PLACE	± 0.25	± ---	± ---																						
DRAFT WHERE APPLICABLE MUST REMAIN WITHIN DIMENSIONS	MATERIAL NO. <b>SEE TABLES</b>	MOLEX INCORPORATED DOCUMENT NO. <b>SD-76763-001</b>	SHEET NO. <b>2 OF 2</b>																						
THIS DRAWING CONTAINS INFORMATION THAT IS PROPRIETARY TO MOLEX INCORPORATED AND SHOULD NOT BE USED WITHOUT WRITTEN PERMISSION																									