

MMDJ3N03BJT

Plastic Power Transistors SO-8 for Surface Mount Applications

- Collector -Emitter Sustaining Voltage — $V_{CE(sus)}$
= 30 Vdc (Min) @ $I_C = 10$ mAdc
- High DC Current Gain —
 $h_{FE} = 85$ (Min) @ $I_C = 0.8$ Adc
= 60 (Min) @ $I_C = 3.0$ Adc
- Low Collector -Emitter Saturation Voltage —
 $V_{CE(sat)} = 0.18$ Vdc (Max) @ $I_C = 1.2$ Adc
= 0.45 Vdc (Max) @ $I_C = 3.0$ Adc
- Miniature SO-8 Surface Mount Package – Saves Board Space



ON Semiconductor®

<http://onsemi.com>

**DUAL BIPOLAR
POWER TRANSISTOR
NPN SILICON
30 VOLTS, 3 AMPERES**

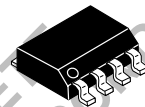

(SO-8)
CASE 751-07
Style 16

Emitter-1	1	8	Collector-1
Base-1	2	7	Collector-1
Emitter-2	3	6	Collector-2
Base-2	4	5	Collector-2

Top View
Pinout

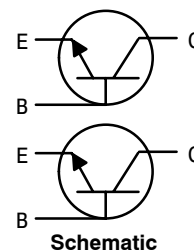

MMDJ3N03BJT

MAXIMUM RATINGS (T_C = 25°C unless otherwise noted)

Rating	Symbol	Value	Unit
Collector–Base Voltage	V _{CB}	45	Vdc
Collector–Emitter Voltage	V _{CEO}	30	Vdc
Emitter–Base Voltage	V _{EB}	±6.0	Vdc
Collector Current — Continuous — Peak	I _C	3.0 5.0	Adc
Base Current — Continuous	I _B	1.0	Adc
Operating and Storage Junction Temperature Range	T _J , T _{stg}	–55 to +150	°C

THERMAL CHARACTERISTICS

Characteristic	Symbol	Max	Unit
Thermal Resistance – Junction to Ambient on 1" sq. (645 sq. mm) Collector pad on FR-4 board material with one die operating.	R _{θJA}	100	°C/W
Thermal Resistance – Junction to Ambient on 0.012" sq. (7.6 sq. mm) Collector pad on FR-4 board material with one die operating.		185	
Total Power Dissipation @ T _A = 25°C mounted on 1" sq. (645 sq. mm) Collector pad on FR-4 board material with one die operating. Derate above 25°C	P _D	1.25 10	W mW/°C
Maximum Temperature for Soldering	T _L	260	°C

ELECTRICAL CHARACTERISTICS (T_C = 25°C unless otherwise noted)

Characteristic	Symbol	Min	Typ	Max	Unit
----------------	--------	-----	-----	-----	------

OFF CHARACTERISTICS

Collector–Emitter Sustaining Voltage (I _C = 10 mAdc, I _B = 0 Adc)	V _{CEO(sus)}	30	—	—	Vdc
Emitter–Base Voltage (I _E = 50 μAdc, I _C = 0 Adc)	V _{EBO}	6.0	—	—	Vdc
Collector Cutoff Current (V _{CE} = 25 Vdc, R _{BE} = 200 Ω) (V _{CE} = 25 Vdc, R _{BE} = 200 Ω, T _J = 125°C)	I _{CER}	— —	— —	20 200	μAdc
Emitter Cutoff Current (V _{BE} = 5.0 Vdc)	I _{EBO}	—	—	10	μAdc

ON CHARACTERISTICS⁽¹⁾

Collector–Emitter Saturation Voltage (I _C = 0.8 Adc, I _B = 20 mAdc) (I _C = 1.2 Adc, I _B = 20 mAdc) (I _C = 3.0 Adc, I _B = 0.3 Adc)	V _{CE(sat)}	— — —	0.105 — —	0.15 0.18 0.45	Vdc
Base–Emitter Saturation Voltage (I _C = 3.0 Adc, I _B = 0.3 Adc)	V _{BE(sat)}	—	—	1.25	Vdc
Base–Emitter On Voltage (I _C = 1.2 Adc, V _{CE} = 4.0 Vdc)	V _{BE(on)}	—	—	1.10	Vdc
DC Current Gain (I _C = 0.8 Adc, V _{CE} = 1.0 Vdc) (I _C = 1.2 Adc, V _{CE} = 1.0 Vdc) (I _C = 3.0 Adc, V _{CE} = 1.0 Vdc)	h _{FE}	85 80 60	195 — —	— — —	—

DYNAMIC CHARACTERISTICS

Output Capacitance (V _{CB} = 10 Vdc, I _E = 0 Adc, f = 1.0 MHz)	C _{ob}	—	85	135	pF
Input Capacitance (V _{EB} = 8.0 Vdc)	C _{ib}	—	200	—	pF
Current–Gain — Bandwidth Product ⁽²⁾ (I _C = 500 mAdc, V _{CE} = 10 Vdc, F _{test} = 1.0 MHz)	f _T	—	72	—	MHz

(1) Pulse Test: Pulse Width ≤ 300 μs, Duty Cycle ≤ 2%.

(2) f_T = |h_{FE}| • f_{test}

MMDJ3N03BJT

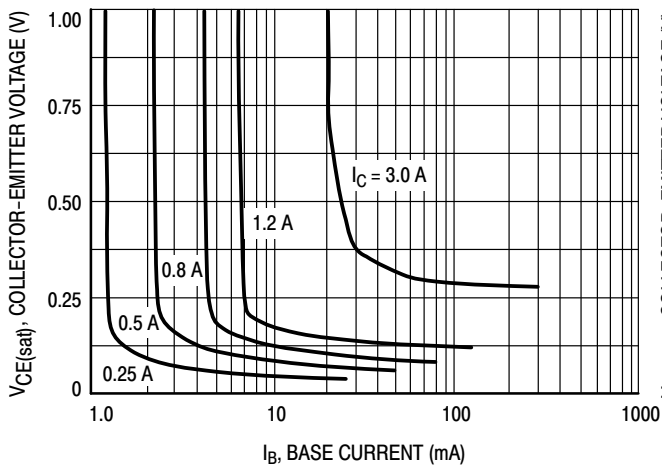

Figure 1. Collector Saturation Region

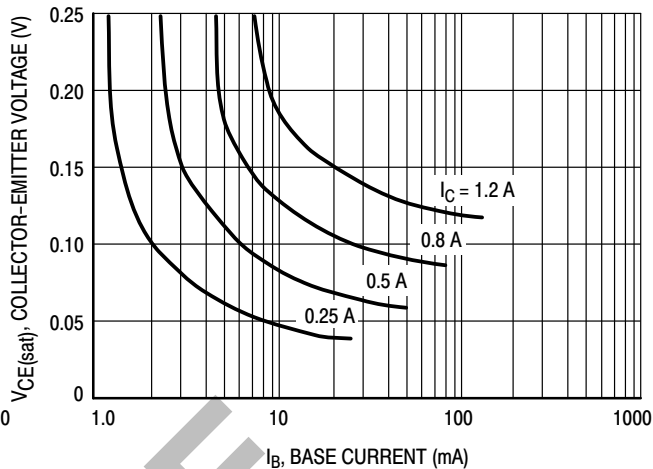

Figure 2. Collector Saturation Region

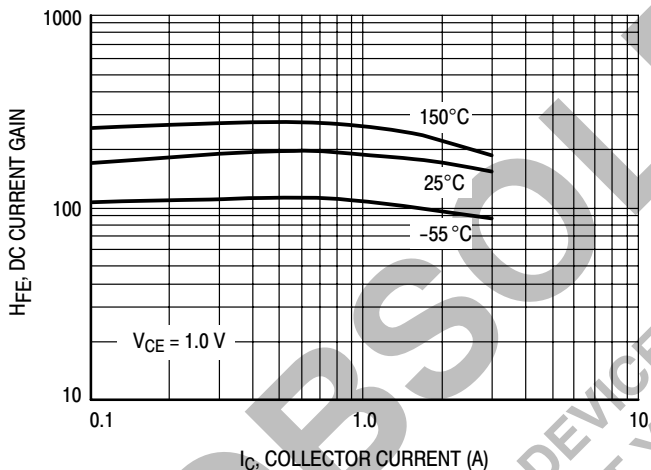

Figure 3. DC Current Gain

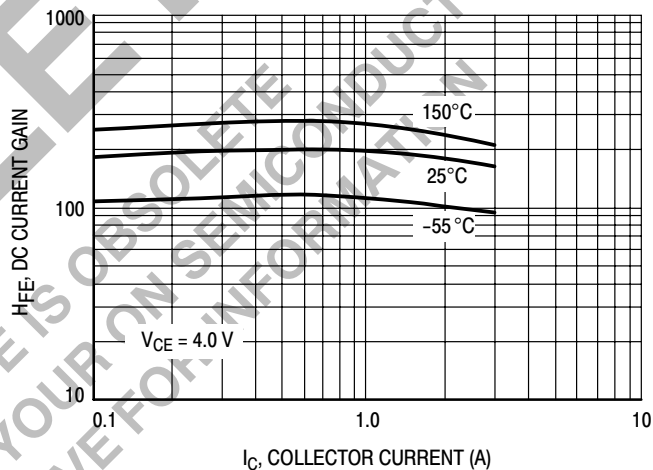

Figure 4. DC Current Gain

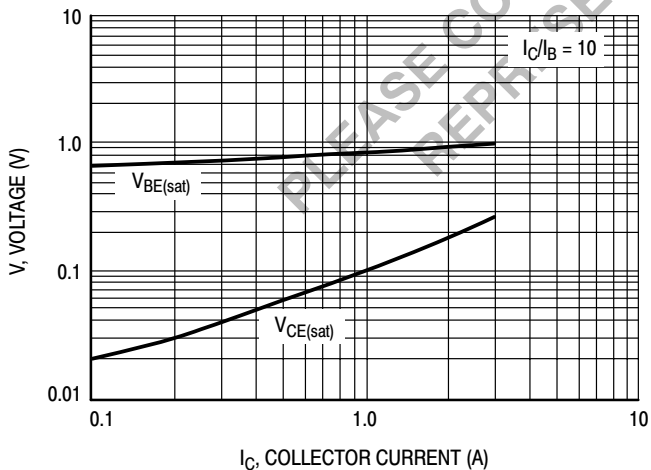

Figure 5. "On" Voltages

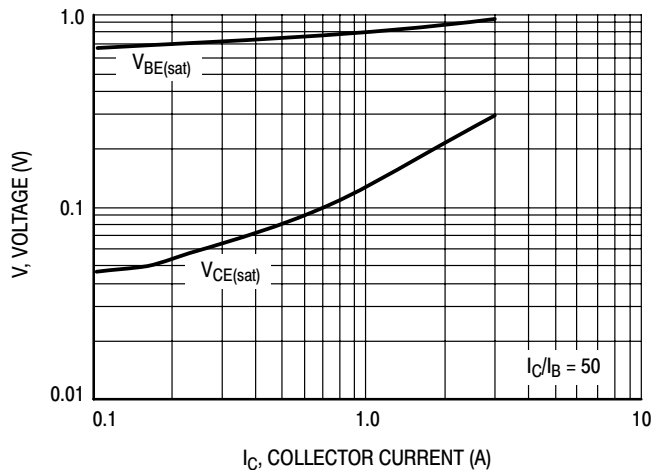

Figure 6. "On" Voltages

MMDJ3N03BJT

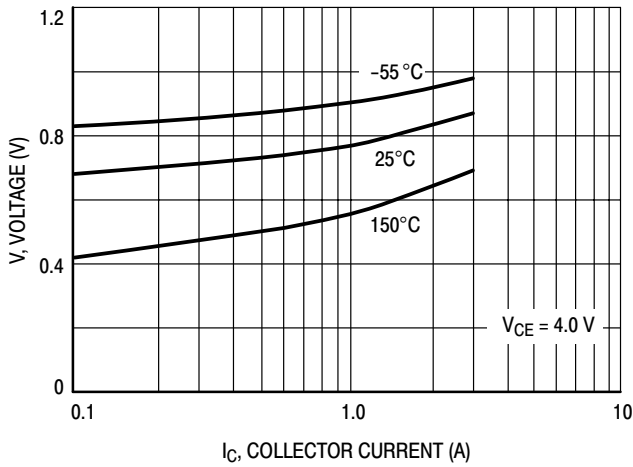

Figure 7. $V_{BE(on)}$ Voltage

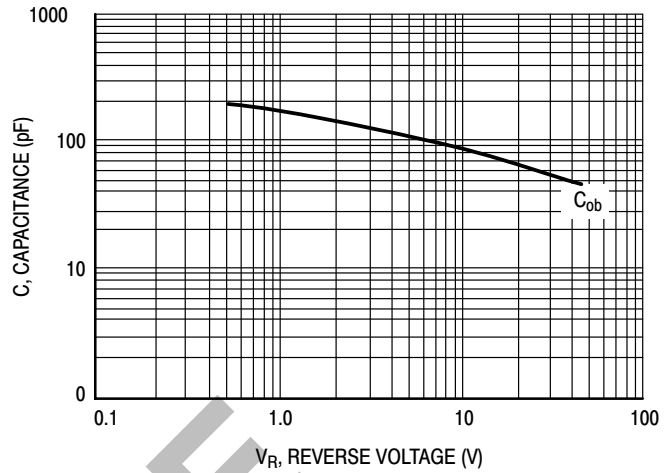

Figure 8. Capacitance

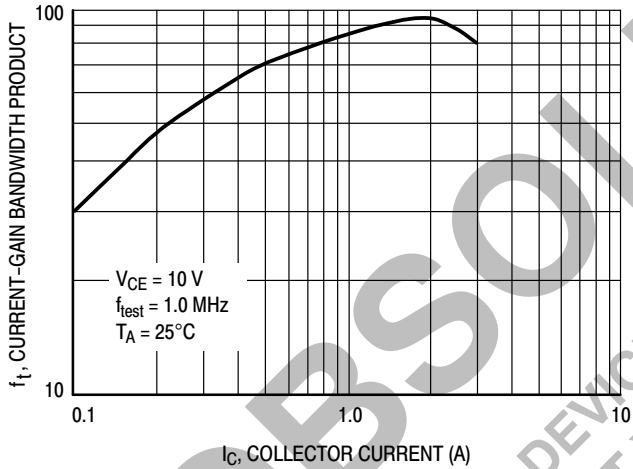

Figure 9. Current-Gain Bandwidth Product

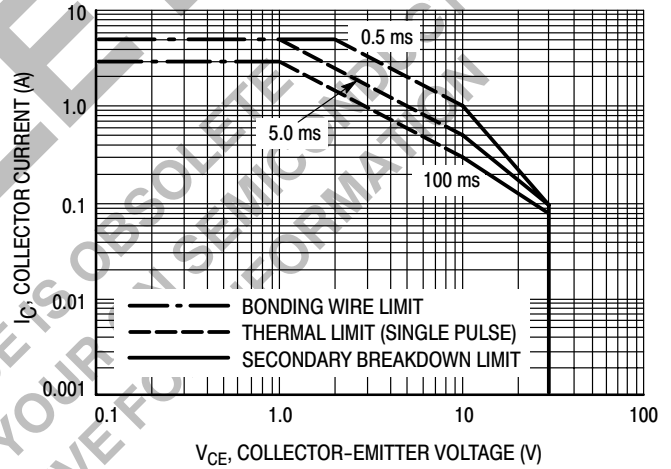

Figure 10. Active Region Safe Operating Area

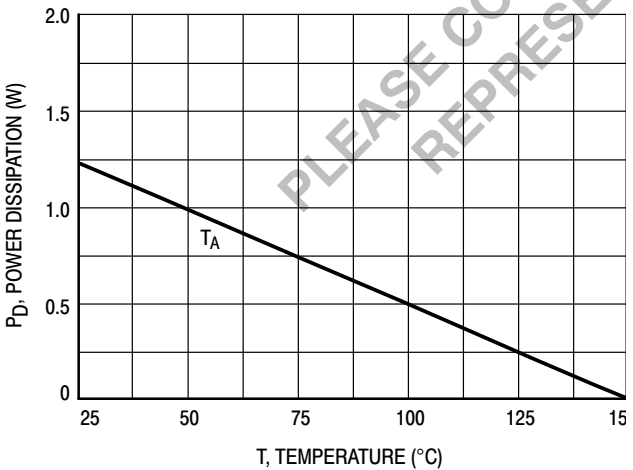

Figure 11. Power Derating

There are two limitations on the power handling ability of a transistor: average junction temperature and secondary breakdown. Safe operating area curves indicate $I_C - V_{CE}$ limits of the transistor that must be observed for reliable operation; i.e., the transistor must not be subjected to greater dissipation than the curves indicate.

The data of Figure 10 is based on $T_{J(pk)} = 150^\circ\text{C}$; T_C is variable depending on conditions. Secondary breakdown pulse limits are valid for duty cycles to 10% provided $T_{J(pk)} \leq 150^\circ\text{C}$. $T_{J(pk)}$ may be calculated from the data in Figure 12. At high case temperatures, thermal limitations will reduce the power that can be handled to values less than the limitations imposed by secondary breakdown.

MMDJ3N03BJT

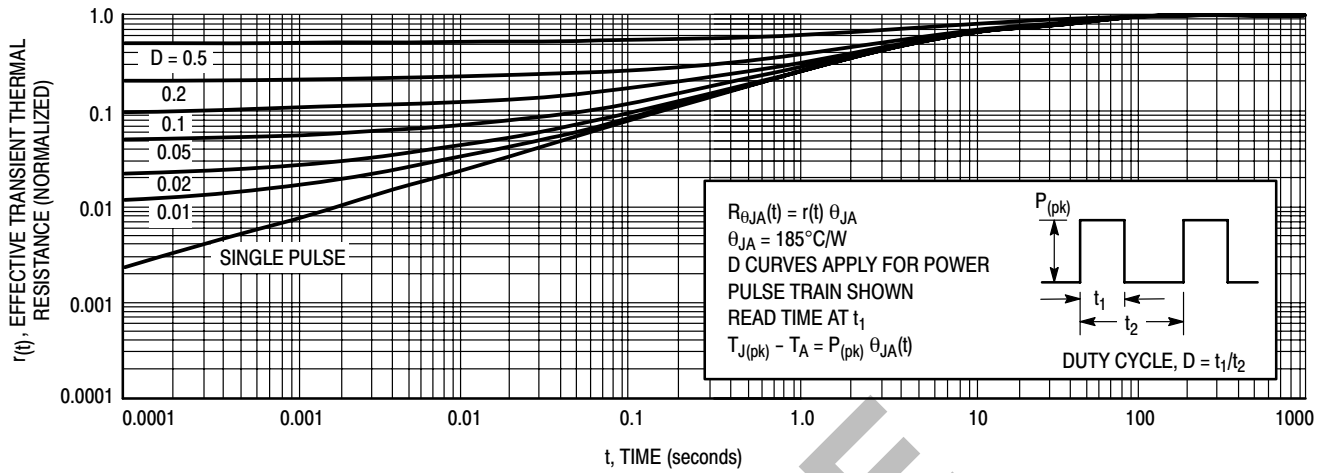

Figure 12. Thermal Response

OBSOLETE
 THIS DEVICE IS OBSOLETE
 PLEASE CONTACT YOUR ON SEMICONDUCTOR
 REPRESENTATIVE FOR INFORMATION

MMDJ3N03BJT

PACKAGE DIMENSIONS

SOIC-8 NB
CASE 751-07
ISSUE W

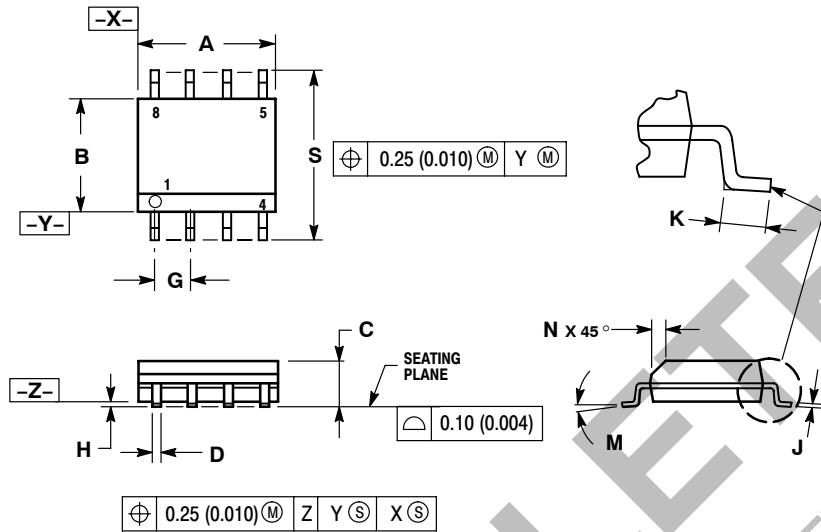

NOTES:

1. DIMENSIONING AND TOLERANCING PER ANSI Y14.5M, 1982.
2. CONTROLLING DIMENSION: MILLIMETER.
3. DIMENSION A AND B DO NOT INCLUDE MOLD PROTRUSION.
4. MAXIMUM MOLD PROTRUSION 0.15 (0.006) PER SIDE.
5. DIMENSION D DOES NOT INCLUDE DAMBAR PROTRUSION. ALLOWABLE DAMBAR PROTRUSION SHALL BE 0.127 (0.005) TOTAL IN EXCESS OF THE D DIMENSION AT MAXIMUM MATERIAL CONDITION.

DIM	MILLIMETERS		INCHES	
	MIN	MAX	MIN	MAX
A	4.80	5.00	0.189	0.197
B	3.80	4.00	0.150	0.157
C	1.35	1.75	0.053	0.069
D	0.33	0.51	0.013	0.020
G	1.27 BSC		0.050 BSC	
H	0.10	0.25	0.004	0.010
J	0.19	0.25	0.007	0.010
K	0.40	1.27	0.016	0.050
M	0°	8°	0°	8°
N	0.25	0.50	0.010	0.020
S	5.80	6.20	0.228	0.244

STYLE 16:

1. PIN 1. EMITTER, DIE #1
2. BASE, DIE #1
3. EMITTER, DIE #2
4. BASE, DIE #2
5. COLLECTOR, DIE #2
6. COLLECTOR, DIE #2
7. COLLECTOR, DIE #1
8. COLLECTOR, DIE #1

ON Semiconductor and are registered trademarks of Semiconductor Components Industries, LLC (SCILLC). SCILLC reserves the right to make changes without further notice to any products herein. SCILLC makes no warranty, representation or guarantee regarding the suitability of its products for any particular purpose, nor does SCILLC assume any liability arising out of the application or use of any product or circuit, and specifically disclaims any and all liability, including without limitation special, consequential or incidental damages. "Typical" parameters which may be provided in SCILLC data sheets and/or specifications can and do vary in different applications and actual performance may vary over time. All operating parameters, including "Typicals" must be validated for each customer application by customer's technical experts. SCILLC does not convey any license under its patent rights nor the rights of others. SCILLC products are not designed, intended, or authorized for use as components in systems intended for surgical implant into the body, or other applications intended to support or sustain life, or for any other application in which the failure of the SCILLC product could create a situation where personal injury or death may occur. Should Buyer purchase or use SCILLC products for any such unintended or unauthorized application, Buyer shall indemnify and hold SCILLC and its officers, employees, subsidiaries, affiliates, and distributors harmless against all claims, costs, damages, and expenses, and reasonable attorney fees arising out of, directly or indirectly, any claim of personal injury or death associated with such unintended or unauthorized use, even if such claim alleges that SCILLC was negligent regarding the design or manufacture of the part. SCILLC is an Equal Opportunity/Affirmative Action Employer. This literature is subject to all applicable copyright laws and is not for resale in any manner.

PUBLICATION ORDERING INFORMATION

LITERATURE FULFILLMENT:

Literature Distribution Center for ON Semiconductor
P.O. Box 5163, Denver, Colorado 80217 USA
Phone: 303-675-2175 or 800-344-3860 Toll Free USA/Canada
Fax: 303-675-2176 or 800-344-3867 Toll Free USA/Canada
Email: orderlit@onsemi.com

N. American Technical Support: 800-282-9855 Toll Free
USA/Canada
Europe, Middle East and Africa Technical Support:
Phone: 421 33 790 2910
Japan Customer Focus Center
Phone: 81-3-5773-3850

ON Semiconductor Website: www.onsemi.com

Order Literature: <http://www.onsemi.com/orderlit>

For additional information, please contact your local Sales Representative