

N-CHANNEL ENHANCEMENT MODE FIELD EFFECT TRANSISTOR
Features

- Low On-Resistance
- Low Gate Threshold Voltage
- Low Input Capacitance
- Fast Switching Speed
- Low Input/Output Leakage
- **Lead, Halogen and Antimony Free, RoHS Compliant "Green" Device (Notes 2 and 4)**

Mechanical Data

- Case: SOT-23
- Case Material: Molded Plastic. UL Flammability Classification Rating 94V-0
- Moisture Sensitivity: Level 1 per J-STD-020C
- Terminal Connections: See Diagram
- Terminals: Solderable per MIL-STD-202, Method 208
- Lead Free Plating (Matte Tin Finish annealed over Alloy 42 leadframe).
- Marking Information: See Page 3
- Ordering Information: See Page 3
- Weight: 0.008 grams (approximate)



TOP VIEW

SOT-23

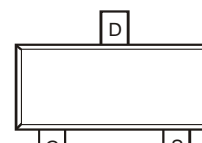
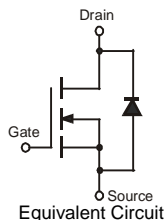

TOP VIEW

Maximum Ratings @ $T_A = 25^\circ\text{C}$ unless otherwise specified

Characteristic	Symbol	Value	Units
Drain-Source Voltage	V_{DSS}	60	V
Drain-Gate Voltage $R_{GS} \leq 1.0M\Omega$	V_{DGR}	60	V
Gate-Source Voltage	V_{GSS}	± 20	V
Drain Current (Note 1)	I_D	250	mA

Thermal Characteristics @ $T_A = 25^\circ\text{C}$ unless otherwise specified

Characteristic	Symbol	Value	Units
Total Power Dissipation (Note 1)	P_d	300	mW
Thermal Resistance, Junction to Ambient	$R_{\theta JA}$	417	$^\circ\text{C}/\text{W}$
Operating and Storage Temperature Range	T_j, T_{STG}	-55 to +150	$^\circ\text{C}$

Electrical Characteristics @ $T_A = 25^\circ\text{C}$ unless otherwise specified

Characteristic	Symbol	Min	Typ	Max	Unit	Test Condition
OFF CHARACTERISTICS (Note 3)						
Drain-Source Breakdown Voltage	BV_{DSS}	60	80	—	V	$V_{GS} = 0V, I_D = 100\mu\text{A}$
Zero Gate Voltage Drain Current	I_{DSS}	—	—	0.5	μA	$V_{DS} = 25V, V_{GS} = 0V$
Gate-Body Leakage	I_{GSS}	—	—	± 10	nA	$V_{GS} = \pm 15V, V_{DS} = 0V$
ON CHARACTERISTICS (Note 3)						
Gate Threshold Voltage	$V_{GS(th)}$	1.0	2.0	3.0	V	$V_{DS} = V_{GS}, I_D = 250\mu\text{A}$
Static Drain-Source On-Resistance	$R_{DS(ON)}$	—	3.5	5.0	Ω	$V_{GS} = 10V, I_D = 0.2A$
On-State Drain Current	$I_{D(ON)}$	—	1.0	0.5	A	$V_{GS} = 10V, V_{DS} = 7.5V$
Forward Transconductance	g_{FS}	80	—	—	mS	$V_{DS} = 10V, I_D = 0.2A$
DYNAMIC CHARACTERISTICS						
Input Capacitance	C_{iss}	—	22	50	pF	$V_{DS} = 10V, V_{GS} = 0V$ $f = 1.0\text{MHz}$
Output Capacitance	C_{oss}	—	11	25	pF	
Reverse Transfer Capacitance	C_{rss}	—	2.0	5.0	pF	
SWITCHING CHARACTERISTICS						
Turn-On Delay Time	$t_{D(ON)}$	—	2.0	20	ns	$V_{ES} = 10V, R_L = 150\Omega,$
Turn-Off Delay Time	$t_{D(OFF)}$	—	5.0	20	ns	$V_{DS} = 10V, R_D = 100\Omega$

- Notes:
1. Device mounted on FR-4 PCB 1.0 x 0.75 x 0.062 inch pad layout as shown on Diodes, Inc. suggested pad layout AP02001, which can be found on our website at <http://www.diodes.com/datasheets/ap02001.pdf>.
 2. No purposefully added lead. Halogen and Antimony Free.
 3. Short duration pulse test used to minimize self-heating effect.
 4. Product manufactured with Data Code V9 (week 33, 2008) and newer are built with Green Molding Compound. Product manufactured prior to Date Code V9 are built with Non-Green Molding Compound and may contain Halogens or Sb_2O_3 Fire Retardants.

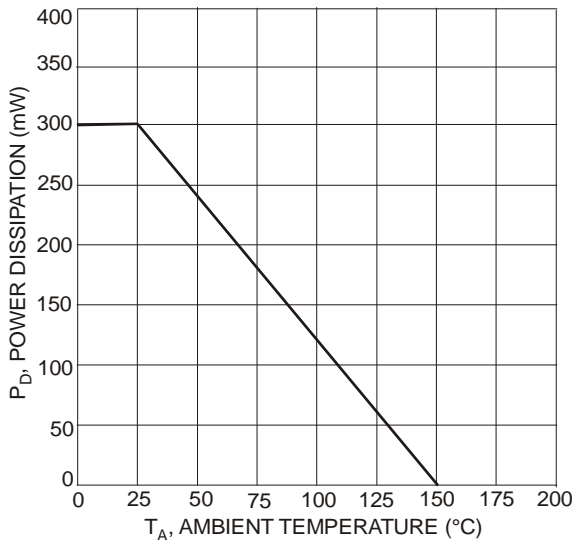
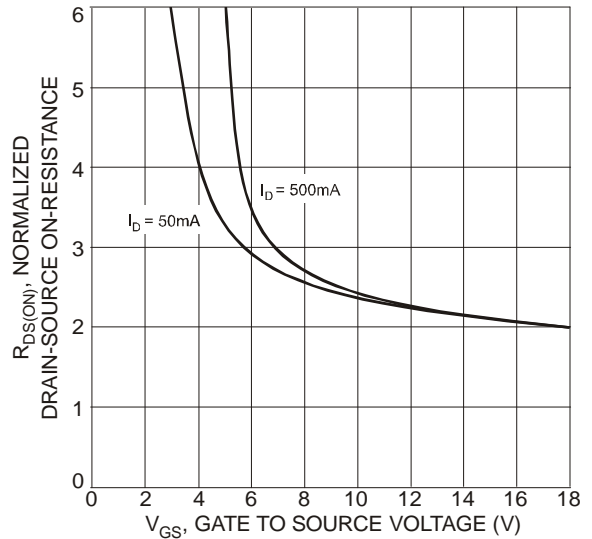
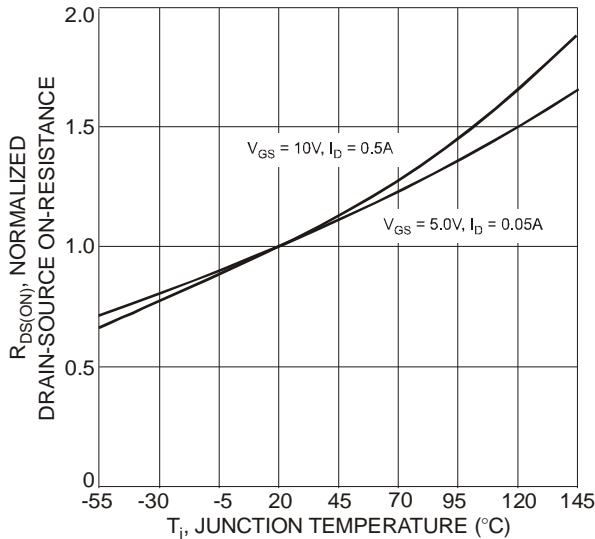
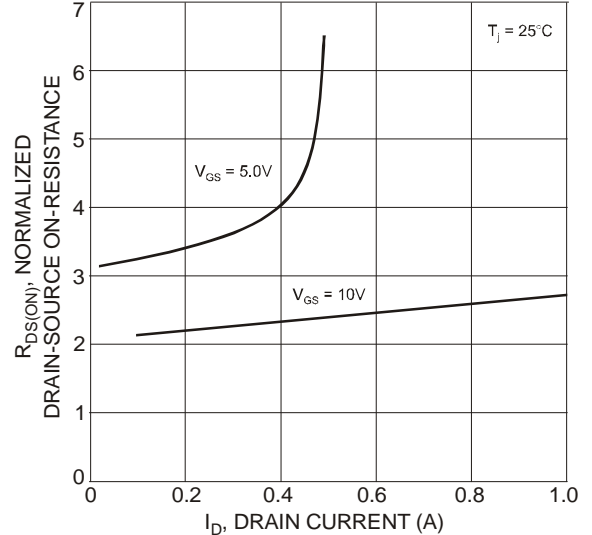
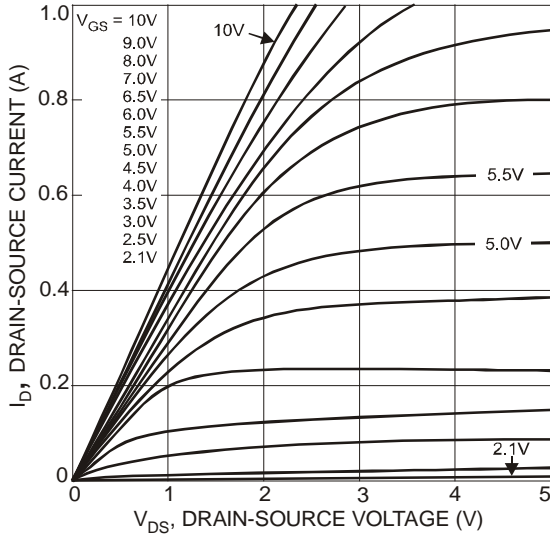

Ordering Information (Note 5)

Part Number	Case	Packaging
BS870-7-F	SOT-23	3000/Tape & Reel

Notes: 5. For packaging details, go to our website at <http://www.diodes.com/datasheets/ap02007.pdf>.

Marking Information

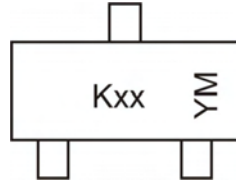

Kxx = Product Type Marking Code, K70 or K6Z
 YM = Date Code Marking
 Y = Year ex: T = 2006
 M = Month ex: 9 = September

Date Code Key

Year	1998	1999	2000	2001	2002	2003	2004	2005	2006	2007	2008	2009	2010	2011	2012
Code	J	K	L	M	N	P	R	S	T	U	V	W	X	Y	Z

Month	Jan	Feb	Mar	Apr	May	Jun	Jul	Aug	Sep	Oct	Nov	Dec
Code	1	2	3	4	5	6	7	8	9	O	N	D

Package Outline Dimensions

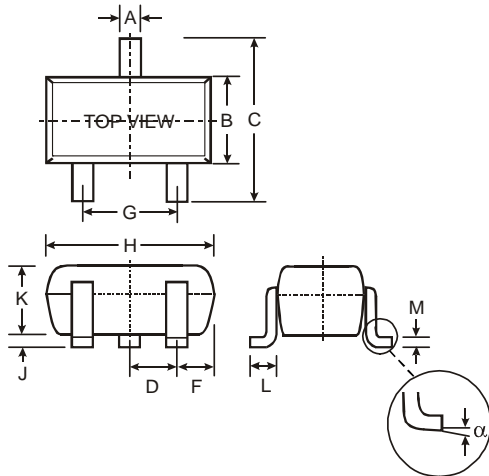

SOT-23		
Dim	Min	Max
A	0.37	0.51
B	1.20	1.40
C	2.30	2.50
D	0.89	1.03
F	0.45	0.60
G	1.78	2.05
H	2.80	3.00
J	0.013	0.10
K	0.903	1.10
L	0.45	0.61
M	0.085	0.180
α	0°	8°
All Dimensions in mm		

Suggested Pad Layout

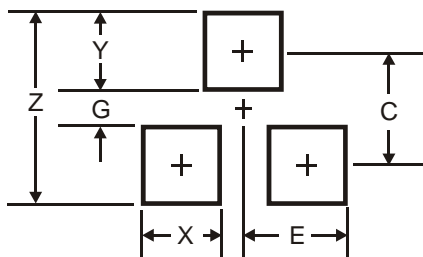

Dimensions	Value (in mm)
Z	3.4
G	0.7
X	0.9
Y	1.4
C	2.0
E	0.9

IMPORTANT NOTICE

Diodes Incorporated and its subsidiaries reserve the right to make modifications, enhancements, improvements, corrections or other changes without further notice to any product herein. Diodes Incorporated does not assume any liability arising out of the application or use of any product described herein; neither does it convey any license under its patent rights, nor the rights of others. The user of products in such applications shall assume all risks of such use and will agree to hold Diodes Incorporated and all the companies whose products are represented on our website, harmless against all damages.

LIFE SUPPORT

Diodes Incorporated products are not authorized for use as critical components in life support devices or systems without the expressed written approval of the President of Diodes Incorporated.