

**OptiMOS™3 Power-Transistor**
**Features**

- N-channel, normal level
- Excellent gate charge x  $R_{DS(on)}$  product (FOM)
- Very low on-resistance  $R_{DS(on)}$
- 175 °C operating temperature
- Pb-free lead plating; RoHS compliant, halogen free
- Qualified according to JEDEC<sup>1)</sup> for target application
- Ideal for high-frequency switching and synchronous rectification

**Product Summary**

$V_{DS}$	120	V
$R_{DS(on),max}$ (TO-263)	3.8	mΩ
$I_D$	120	A

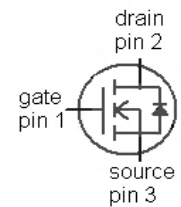

Type	IPB038N12N3 G	IPI041N12N3 G	IPP041N12N3 G
<b>Package</b>	PG-TO263-3	PG-TO262-3	PG-TO220-3
<b>Marking</b>	038N12N	041N12N	041N12N

**Maximum ratings, at  $T_j=25\text{ °C}$ , unless otherwise specified**

Parameter	Symbol	Conditions	Value	Unit
Continuous drain current	$I_D$	$T_C=25\text{ °C}^{2)}$	120	A
		$T_C=100\text{ °C}$	120	
Pulsed drain current <sup>3)</sup>	$I_{D,pulse}$	$T_C=25\text{ °C}$	480	
Avalanche energy, single pulse	$E_{AS}$	$I_D=100\text{ A}$ , $R_{GS}=25\text{ Ω}$	900	mJ
Gate source voltage <sup>4)</sup>	$V_{GS}$		±20	V
Power dissipation	$P_{tot}$	$T_C=25\text{ °C}$	300	W
Operating and storage temperature	$T_j$ , $T_{stg}$		-55 ... 175	°C
IEC climatic category; DIN IEC 68-1			55/175/56	

Parameter	Symbol	Conditions	Values			Unit
			min.	typ.	max.	

**Thermal characteristics**

Thermal resistance, junction - case	$R_{thJC}$		-	-	0.5	K/W
Thermal resistance, junction - ambient	$R_{thJA}$	minimal footprint	-	-	62	
		6 cm <sup>2</sup> cooling area <sup>5)</sup>	-	-	40	

**Electrical characteristics, at  $T_j=25\text{ }^\circ\text{C}$ , unless otherwise specified**
**Static characteristics**

Drain-source breakdown voltage	$V_{(BR)DSS}$	$V_{GS}=0\text{ V}, I_D=1\text{ mA}$	120	-	-	V
Gate threshold voltage	$V_{GS(th)}$	$V_{DS}=V_{GS}, I_D=270\text{ }\mu\text{A}$	2	3	4	
Zero gate voltage drain current	$I_{DSS}$	$V_{DS}=100\text{ V}, V_{GS}=0\text{ V}, T_j=25\text{ }^\circ\text{C}$	-	0.1	1	$\mu\text{A}$
		$V_{DS}=100\text{ V}, V_{GS}=0\text{ V}, T_j=125\text{ }^\circ\text{C}$	-	10	100	
Gate-source leakage current	$I_{GSS}$	$V_{GS}=20\text{ V}, V_{DS}=0\text{ V}$	-	1	100	nA
Drain-source on-state resistance	$R_{DS(on)}$	$V_{GS}=10\text{ V}, I_D=100\text{ A}$	-	3.5	4.1	m $\Omega$
		$V_{GS}=10\text{ V}, I_D=100\text{ A}, \text{TO263}$	-	3.2	3.8	
Gate resistance	$R_G$		-	1.4	-	$\Omega$
Transconductance	$g_{fs}$	$ V_{DS} >2 I_D R_{DS(on)max}, I_D=100\text{ A}$	83	165	-	S

<sup>1)</sup>J-STD20 and JESD22

<sup>2)</sup> Current is limited by bondwire; with an  $R_{thJC}=0.5\text{ K/W}$  the chip is able to carry 182 A.

<sup>3)</sup> See figure 3

<sup>4)</sup>  $T_{jmax}=150\text{ }^\circ\text{C}$  and duty cycle  $D=0.01$  for  $V_{gs}<-5\text{ V}$ 
<sup>5)</sup> Device on 40 mm x 40 mm x 1.5 mm epoxy PCB FR4 with 6 cm<sup>2</sup> (one layer, 70  $\mu\text{m}$  thick) copper area for drain connection. PCB is vertical in still air.

Parameter	Symbol	Conditions	Values			Unit
			min.	typ.	max.	

**Dynamic characteristics**

Input capacitance	$C_{iss}$	$V_{GS}=0\text{ V}, V_{DS}=60\text{ V},$ $f=1\text{ MHz}$	-	10400	13800	pF
Output capacitance	$C_{oss}$		-	1320	1760	
Reverse transfer capacitance	$C_{rss}$		-	61	-	
Turn-on delay time	$t_{d(on)}$	$V_{DD}=60\text{ V}, V_{GS}=10\text{ V},$ $I_D=100\text{ A}, R_G=1.6\ \Omega$	-	35	-	ns
Rise time	$t_r$		-	52.0	-	
Turn-off delay time	$t_{d(off)}$		-	70	-	
Fall time	$t_f$		-	21	-	

**Gate Charge Characteristics<sup>6)</sup>**

Gate to source charge	$Q_{gs}$	$V_{DD}=60.1\text{ V},$ $I_D=100\text{ A},$ $V_{GS}=0\text{ to }10\text{ V}$	-	52	-	nC
Gate to drain charge	$Q_{gd}$		-	37	-	
Switching charge	$Q_{sw}$		-	58	-	
Gate charge total	$Q_g$		-	158	211	
Gate plateau voltage	$V_{plateau}$		-	5.0	-	
Output charge	$Q_{oss}$	$V_{DD}=60.1\text{ V}, V_{GS}=0\text{ V}$	-	182	243	nC

**Reverse Diode**

Diode continuous forward current	$I_S$	$T_C=25\text{ }^\circ\text{C}$	-	-	120	A
Diode pulse current	$I_{S,pulse}$		-	-	480	
Diode forward voltage	$V_{SD}$	$V_{GS}=0\text{ V}, I_F=100\text{ A},$ $T_j=25\text{ }^\circ\text{C}$	-	0.9	1.2	V
Reverse recovery time	$t_{rr}$	$V_R=60\text{ V}, I_F=I_S,$ $di_F/dt=100\text{ A}/\mu\text{s}$	-	123	-	ns
Reverse recovery charge	$Q_{rr}$		-	356	-	nC

<sup>6)</sup> See figure 16 for gate charge parameter definition

**1 Power dissipation**

$$P_{\text{tot}} = f(T_C)$$

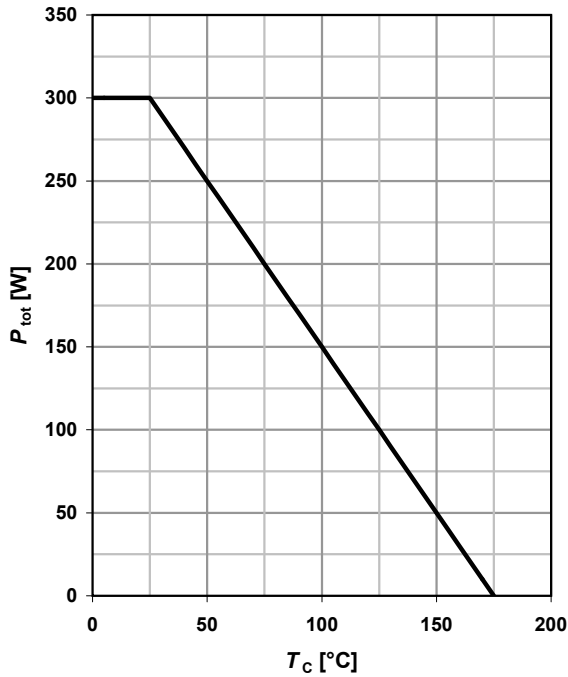

**2 Drain current**

$$I_D = f(T_C); V_{GS} \geq 10 \text{ V}$$

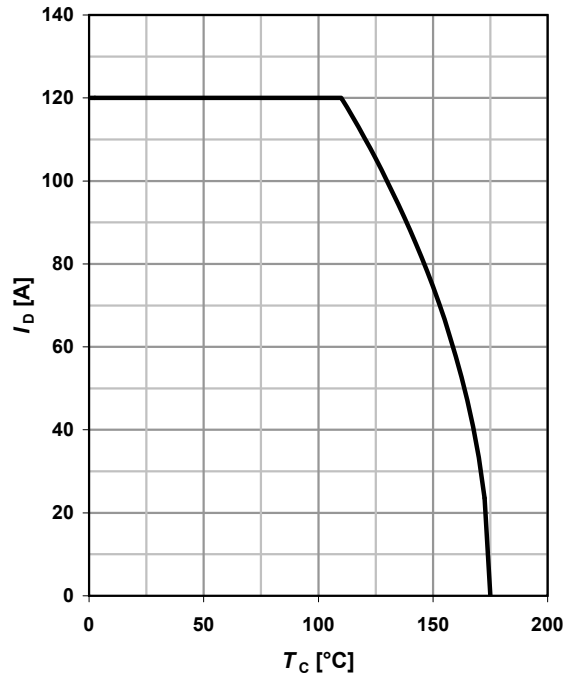

**3 Safe operating area**

$$I_D = f(V_{DS}); T_C = 25 \text{ °C}; D = 0$$

parameter:  $t_p$

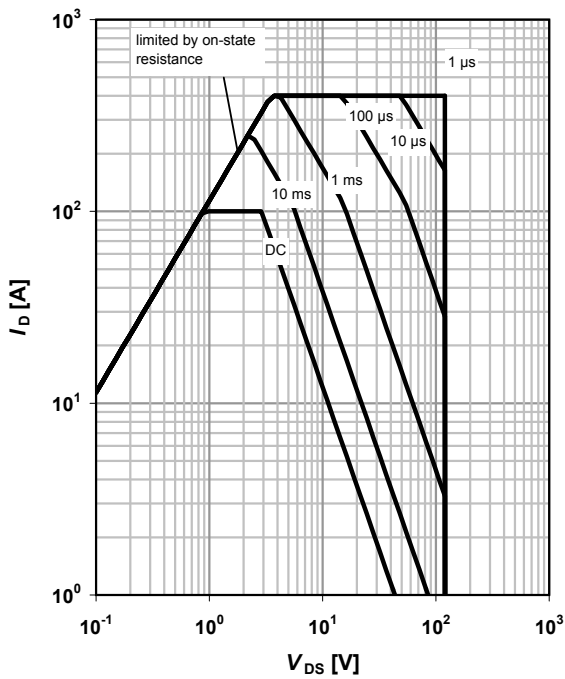

**4 Max. transient thermal impedance**

$$Z_{\text{thJC}} = f(t_p)$$

parameter:  $D = t_p / T$

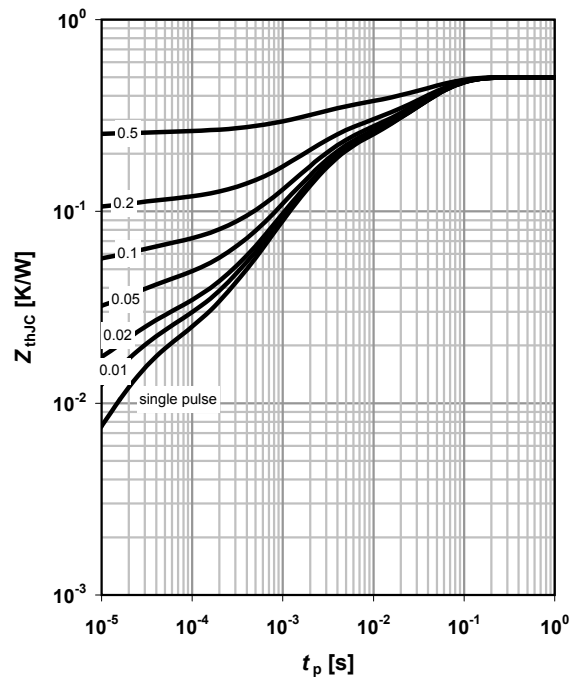

**5 Typ. output characteristics**

$I_D = f(V_{DS}); T_j = 25\text{ }^\circ\text{C}$

parameter:  $V_{GS}$

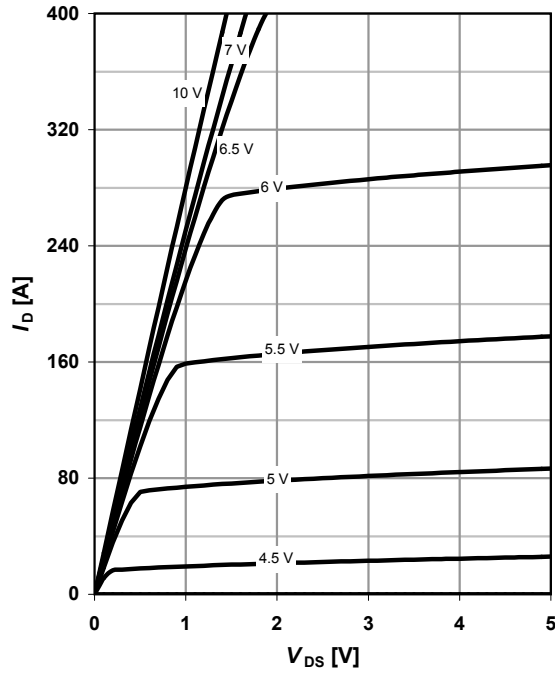

**6 Typ. drain-source on resistance**

$R_{DS(on)} = f(I_D); T_j = 25\text{ }^\circ\text{C}$

parameter:  $V_{GS}$

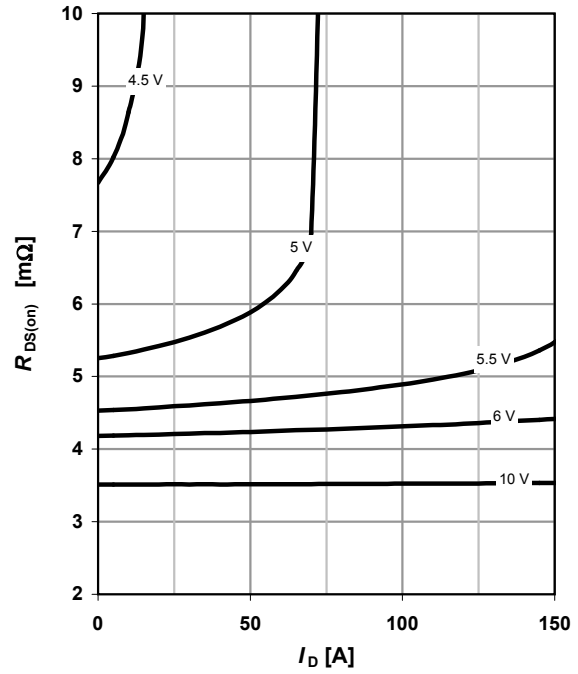

**7 Typ. transfer characteristics**

$I_D = f(V_{GS}); |V_{DS}| > 2|I_D|R_{DS(on)max}$

parameter:  $T_j$

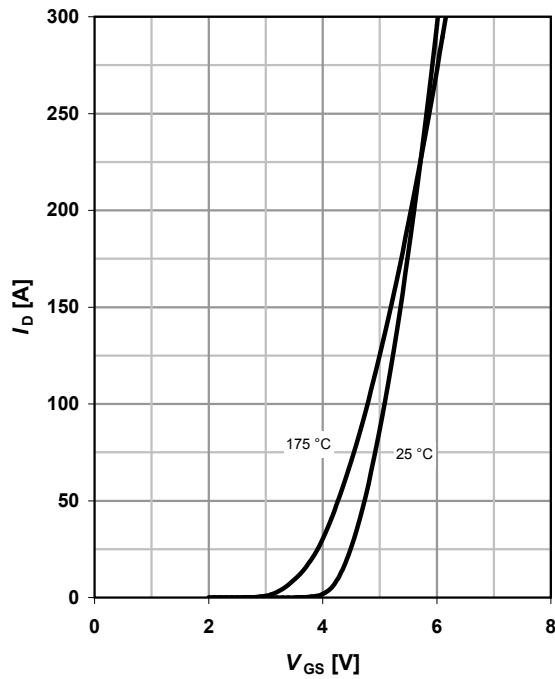

**8 Typ. forward transconductance**

$g_{fs} = f(I_D); T_j = 25\text{ }^\circ\text{C}$

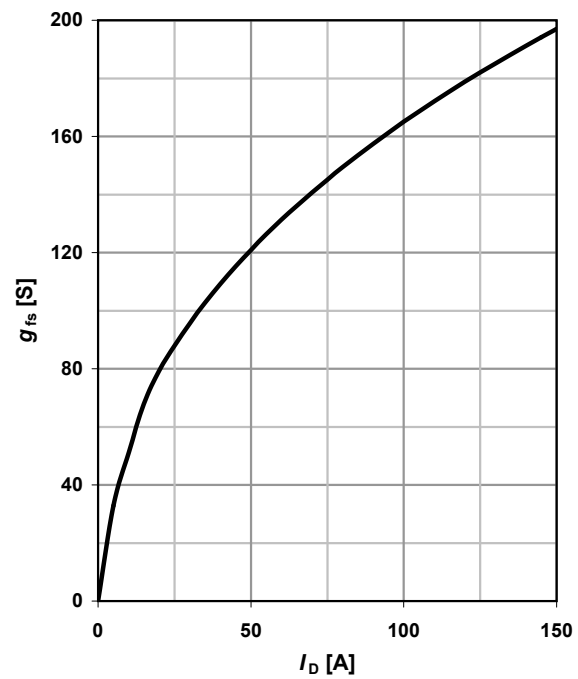

**9 Drain-source on-state resistance**

$R_{DS(on)} = f(T_j); I_D = 100 \text{ A}; V_{GS} = 10 \text{ V}$

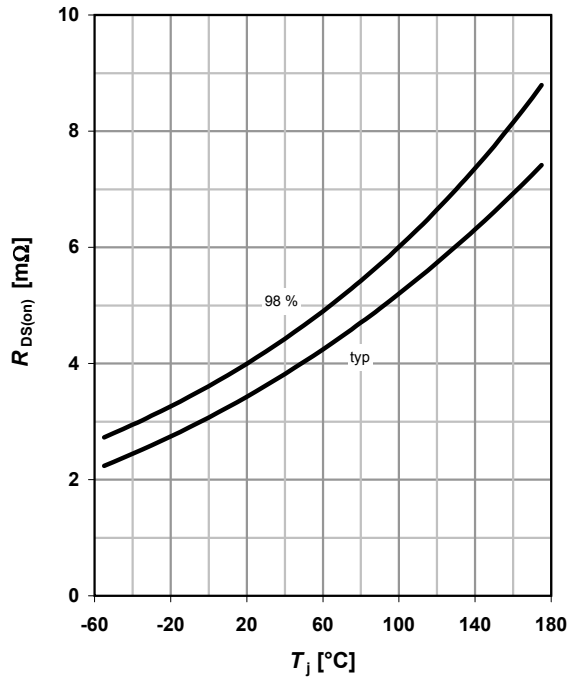

**10 Typ. gate threshold voltage**

$V_{GS(th)} = f(T_j); V_{GS} = V_{DS}$

parameter:  $I_D$

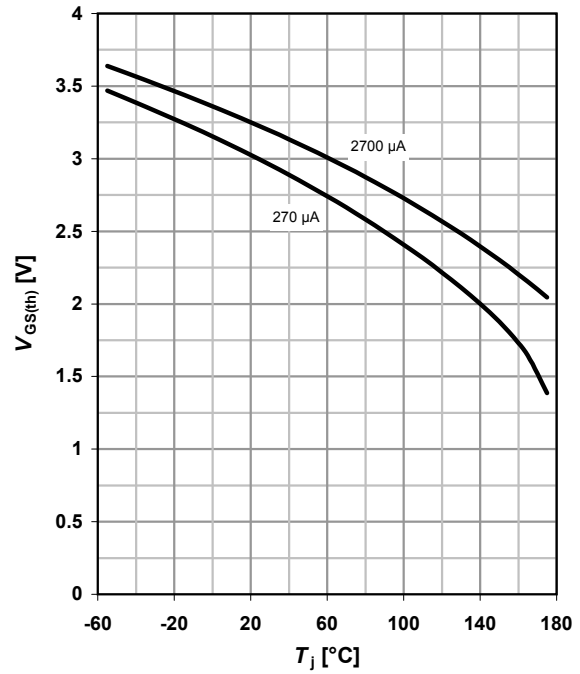

**11 Typ. capacitances**

$C = f(V_{DS}); V_{GS} = 0 \text{ V}; f = 1 \text{ MHz}$

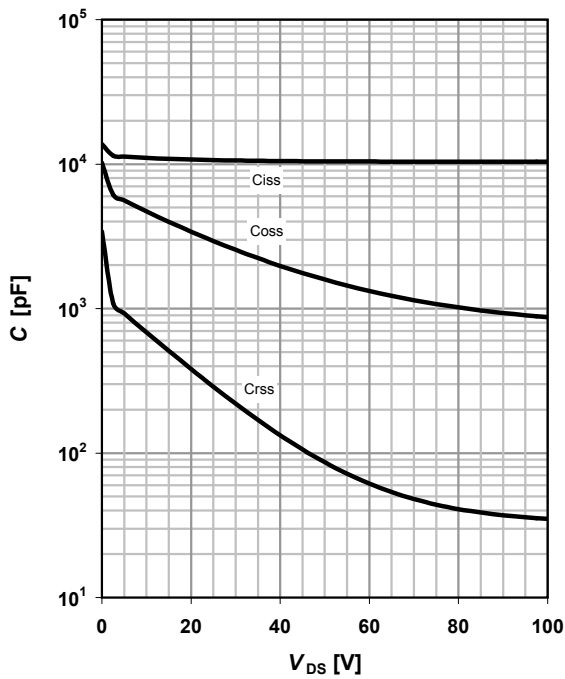

**12 Forward characteristics of reverse diode**

$I_F = f(V_{SD})$

parameter:  $T_j$

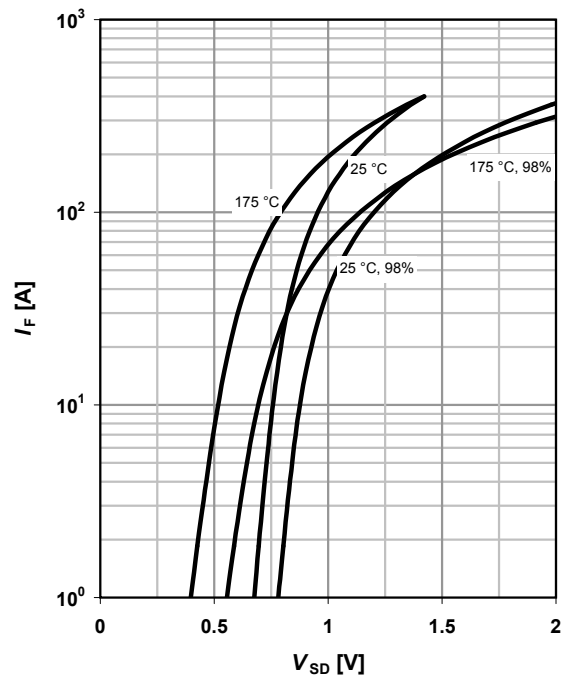

**13 Avalanche characteristics**

$I_{AS}=f(t_{AV}); R_{GS}=25 \Omega$

parameter:  $T_{j(start)}$

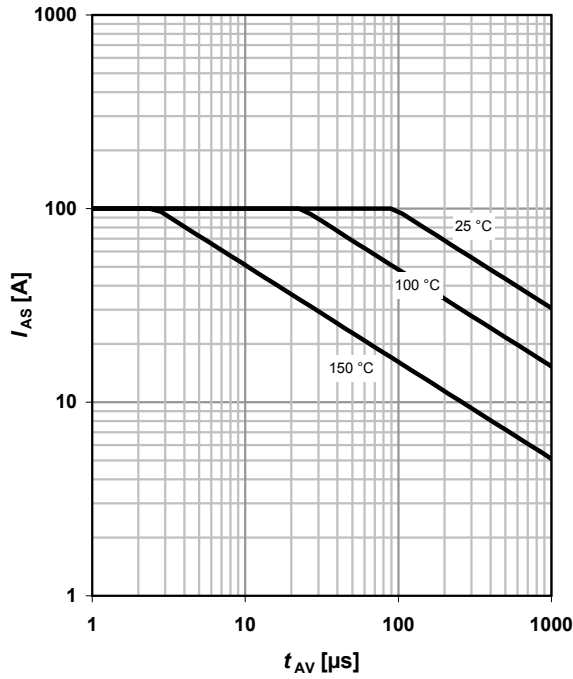

**14 Typ. gate charge**

$V_{GS}=f(Q_{gate}); I_D=100 \text{ A pulsed}$

parameter:  $V_{DD}$

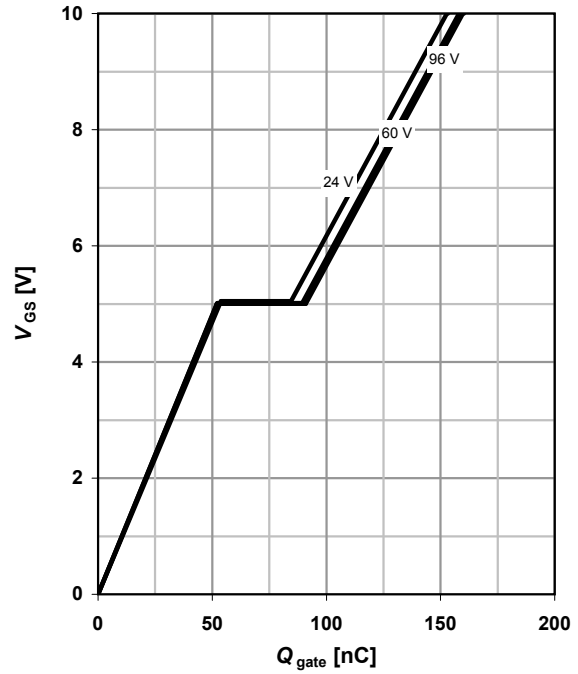

**15 Drain-source breakdown voltage**

$V_{BR(DSS)}=f(T_j); I_D=1 \text{ mA}$

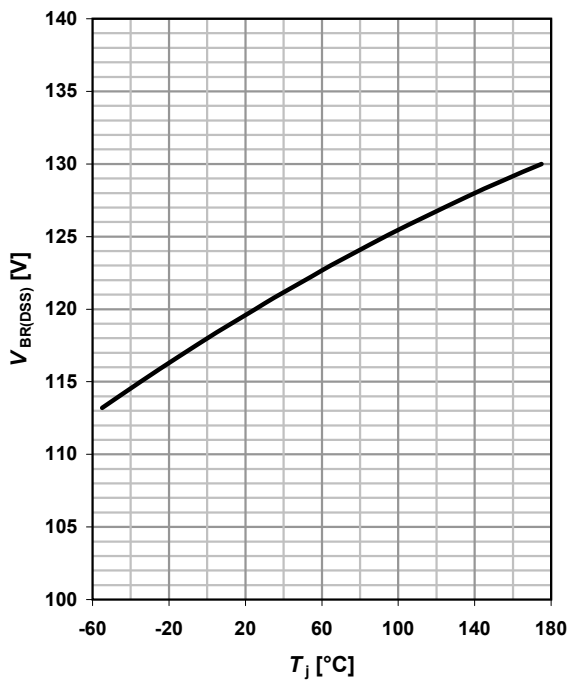

**16 Gate charge waveforms**

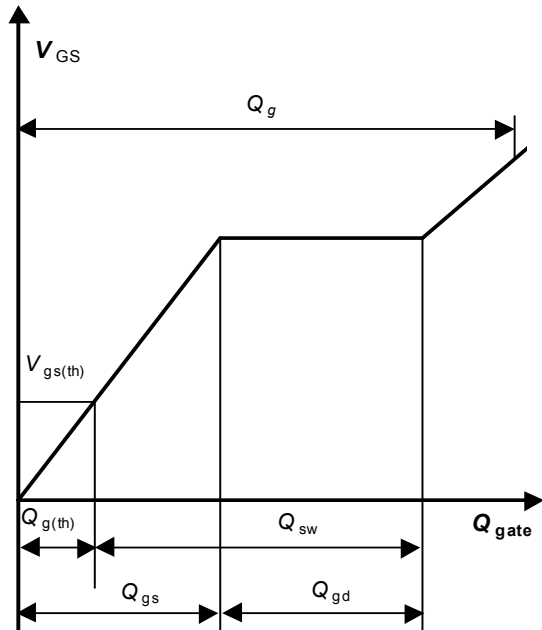

PG-TO220-3: Outline

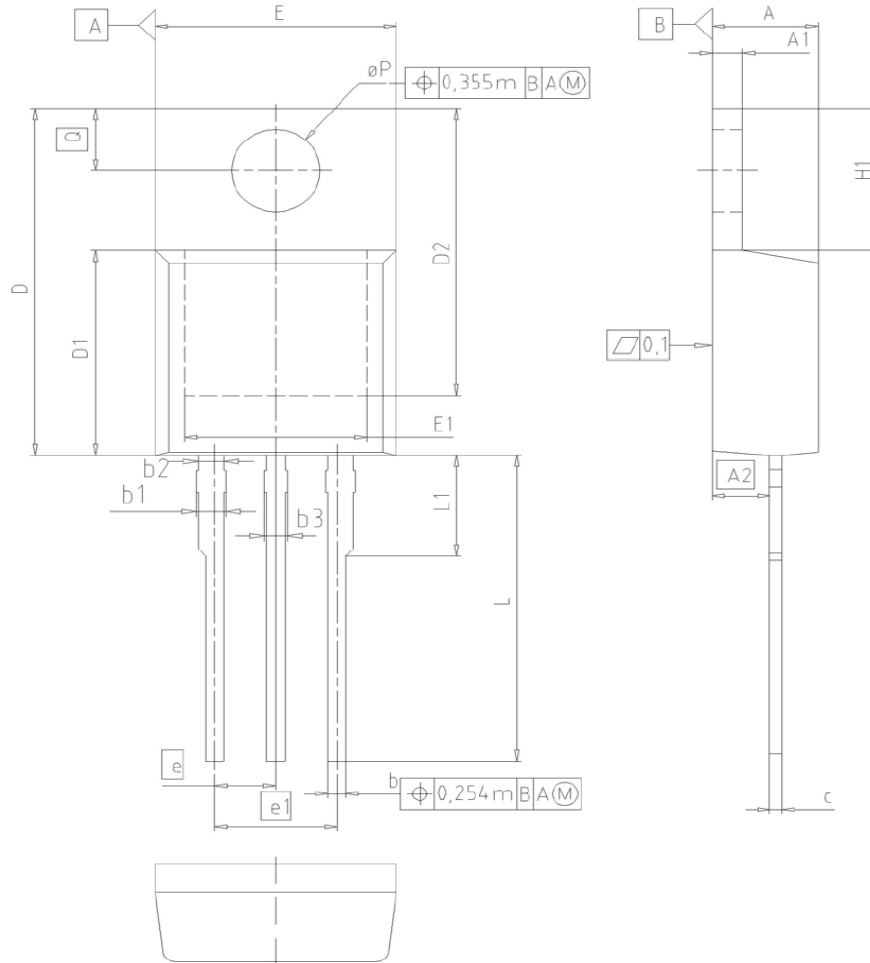

DIM	MILLIMETERS		INCHES	
	MIN	MAX	MIN	MAX
A	4.30	4.57	0.169	0.180
A1	1.17	1.40	0.046	0.055
A2	2.15	2.72	0.085	0.107
b	0.65	0.86	0.026	0.034
b1	0.95	1.40	0.037	0.055
b2	0.95	1.15	0.037	0.045
b3	0.65	1.15	0.026	0.045
c	0.33	0.60	0.013	0.024
D	14.81	15.95	0.583	0.628
D1	8.51	9.45	0.335	0.372
D2	12.19	13.10	0.480	0.516
E	9.70	10.36	0.382	0.408
E1	6.50	8.60	0.256	0.339
e	2.54		0.100	
e1	5.08		0.200	
N	3		3	
H1	5.90	6.90	0.232	0.272
L	13.00	14.00	0.512	0.551
L1	-	4.80	-	0.189
$\phi P$	3.60	3.89	0.142	0.153
Q	2.60	3.00	0.102	0.118

**DOCUMENT NO.**  
Z8B00003318

**SCALE** 0 2.5 5mm

**EUROPEAN PROJECTION**

**ISSUE DATE**  
23-08-2007

**REVISION**  
05



PG-TO-262-3-1 (I<sup>2</sup>-PAK)

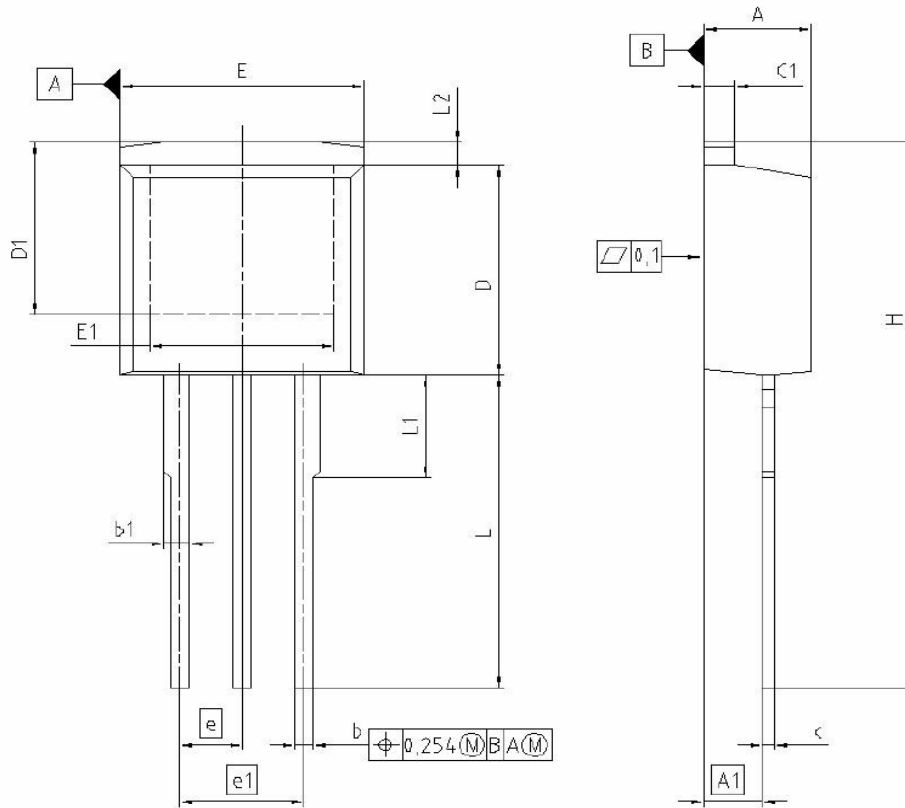

DIM	MILLIMETERS		INCHES	
	MIN	MAX	MIN	MAX
A	4.300	4.500	0.169	0.177
A1	2.150	2.650	0.085	0.104
b	0.650	0.850	0.026	0.033
b1	0.635	1.400	0.025	0.055
c	0.400	0.600	0.016	0.024
c1	1.170	1.370	0.046	0.054
D	9.050	9.450	0.356	0.372
D1	6.900	7.650	0.272	0.301
E	9.800	10.200	0.386	0.402
E1	7.250	8.600	0.285	0.339
e	2.540		0.100	
e1	5.080		0.200	
N	3		3	
L	13.000	14.000	0.512	0.551
L1	4.350	4.750	0.171	0.187
L2	0.700	1.300	0.028	0.051

REFERENCE  
JEDEC TO262

SCALE

EUROPEAN PROJECTION

ISSUE DATE  
01-06-2005

FILE  
TO262\_1

PG-TO-263 (D<sup>2</sup>-Pak)

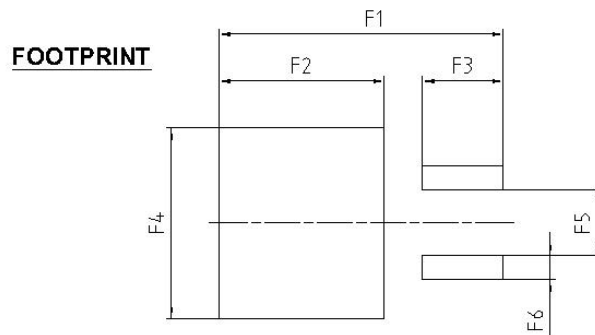
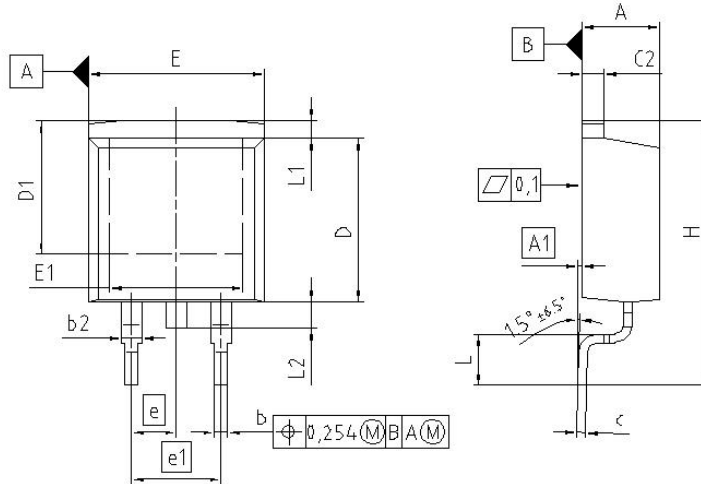

DIM	MILLIMETERS		INCHES	
	MIN	MAX	MIN	MAX
A	4.300	4.572	0.169	0.180
A1	0.000	0.254	0.000	0.010
b	0.650	0.850	0.026	0.033
b2	0.950	1.321	0.037	0.052
c	0.330	0.650	0.013	0.026
c2	0.170	1.400	0.046	0.055
D	8.509	9.450	0.335	0.372
D1	7.100	-	0.280	-
E	9.800	10.312	0.386	0.406
E1	6.500	-	0.256	-
e	2.540		0.100	
e1	5.080		0.200	
N	2		2	
H	14.605	15.875	0.575	0.625
L	2.200	3.000	0.087	0.118
L1	-	1.600	-	0.063
L2	1.000	1.778	0.039	0.070
F1	16.050	16.250	0.632	0.640
F2	9.300	9.500	0.366	0.374
F3	4.500	4.700	0.177	0.185
F4	10.700	10.900	0.421	0.429
F5	3.630	3.830	0.143	0.151
F6	1.100	1.300	0.043	0.051

**REFERENCE**  
JEDEC TO263

**SCALE**

**EUROPEAN PROJECTION**

**ISSUE DATE**  
12-02-2006

**FILE**  
TO263\_2

**Published by**  
Infineon Technologies AG  
81726 München, Germany  
© Infineon Technologies AG 2006.  
All Rights Reserved.

**Attention please!**

The information given in this data sheet shall in no event be regarded as a guarantee of conditions or characteristics ("Beschaffenheitsgarantie"). With respect to any examples or hints given herein, any typical values stated herein and/or any information regarding the application of the device, Infineon Technologies hereby disclaims any and all warranties and liabilities of any kind, including without limitation warranties of non-infringement of intellectual property rights of any third party.

**Information**

For further information on technology, delivery terms and conditions and prices please contact your nearest Infineon Technologies Office ([www.infineon.com](http://www.infineon.com)).

**Warnings**

Due to technical requirements components may contain dangerous substances. For information on the types in question please contact your nearest Infineon Technologies Office.  
Infineon Technologies Components may only be used in life-support devices or systems with the express written approval of Infineon Technologies, if a failure of such components can reasonably be expected to cause the failure of that life-support device or system, or to affect the safety or effectiveness of that device or system. Life support devices or systems are intended to be implanted in the human body, or to support and/or maintain and sustain and/or protect human life. If they fail, it is reasonable to assume that the health of the user or other persons may be endangered.