

Power Management Switch IC Series for PCs and Digital Consumer Product



MOSFET Controller IC for Load Switching

BD2270HFV

No.09029EAT01

●Description

The BD2270HFV is an IC with a single built-in external N-channel MOSFET driver circuit. This IC has a built-in charge pump circuit for gate drive and output discharge circuit, enabling configuration of a high side load switch for N-channel MOSFET drive without using any external parts.

In addition, the control input terminal has a built-in comparator with hysteresis function, facilitating control of the power up sequence. The space saving type of HVSO5 package is used.

●Features

- 1) Built-in charge pump
- 2) Built-in discharge circuit for output charge
- 3) Soft start circuit
- 4) Built-in comparator with hysteresis function at control input terminal
- 5) Compact HVSO5 package
- 6) Operating current 50 μ A
- 7) Standby current 5 μ A
- 8) Possible to drive N-channel power MOSFET

●Applications

PCs, PC peripheral devices, digital consumer electronics, etc.

●Absolute Maximum Ratings

Parameter	Symbol	Limits	Unit
Supply voltage	V _{CC}	-0.3 ~ 6.0	V
AEN voltage	VAEN	-0.3 ~ 6.0	V
DISC voltage	V _{DISC}	-0.3 ~ 6.0	V
GATE voltage	V _{GATE}	-0.3 ~ 15.0	V
Storage temperature range	T _{STG}	-55 ~ 150	°C
Power dissipation	P _d	669 ^{*1}	mW

*1 When mounted on a 70 mm×70 mm×1.6 mm glass epoxy PCB, derated at 5.352 mW/°C above Ta=25°C

*2 This IC is not designed to be radiation-proof.

●Operating Conditions

Parameter	Symbol	Limits	Unit
Operating voltage range	V _{CC}	2.7 ~ 5.5	V
Operating temperature range	T _{OPR}	-25 ~ 85	°C

•Electrical Characteristics

(V_{CC} =3.0V, Ta=25°C unless otherwise specified)

Parameter	Symbol	Limits			Unit	Condition
		Min.	Typ.	Max.		
Operating current	I _{CC}	-	50	75	μA	V _{AEN} = 2.5V
Standby current	I _{STB}	-	5	10	μA	V _{AEN} = 0V
AEN input voltage	V _{AENH}	1.55	2	2.45	V	High level input
	V _{AENL}	1.35	1.9	2.35	V	Low level input
AEN input current	I _{AEN}	-	3	5	μA	V _{AEN} = 3V
GATE output voltage	V _{GATE}	10	13.5	15	V	V _{CC} =5V
		6.6	9.5	9.9	V	V _{CC} =3.3V
		6	8.5	9	V	V _{CC} =3V
GATE rise time	T _{ON}	-	130	750	μs	C _{GATE} =500pF V _{CC} =3V V _{GATE} > 4V
GATE fall time	T _{OFF}	-	18	60	μs	C _{GATE} = 500pF V _{CC} =3V V _{GATE} < 0.5V
DISC discharge resistance	R _{DISC}	-	200	300	Ω	V _{AEN} =0V

•Measurement Circuit

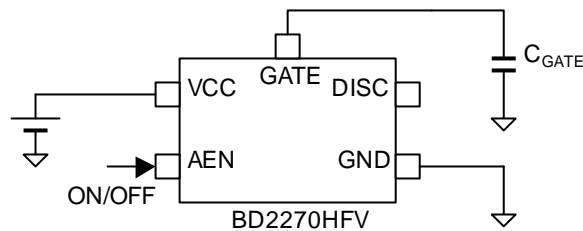

Fig.1 Measurement Circuit

•Timing Diagram

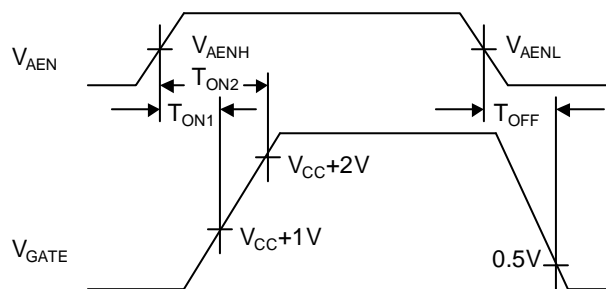

Fig.2 Timing Diagram

●Reference Data

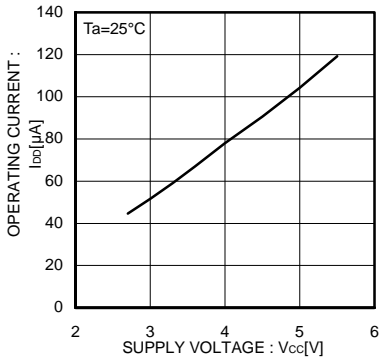

Fig.3 Operating Current
AEN Enable

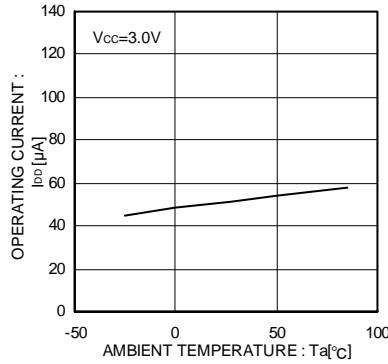

Fig.4 Operating Current
AEN Enable

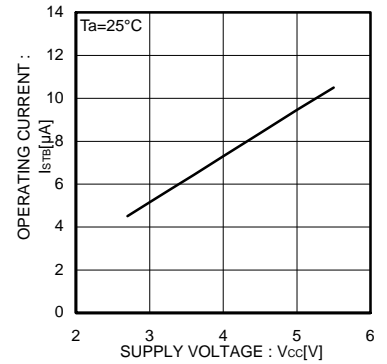

Fig.5 Standby Current
AEN Disable

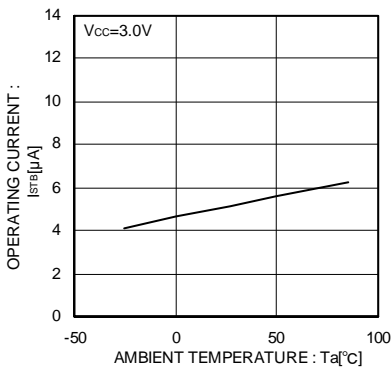

Fig.6 Standby Current
AEN Disable

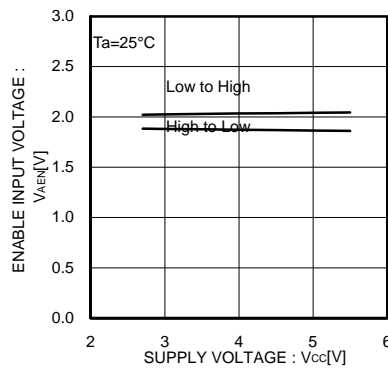

Fig.7 AEN Input Voltage

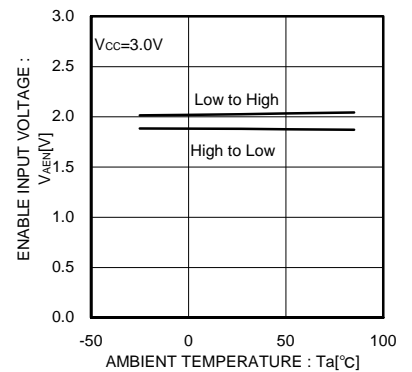

Fig.8 AEN Input Voltage

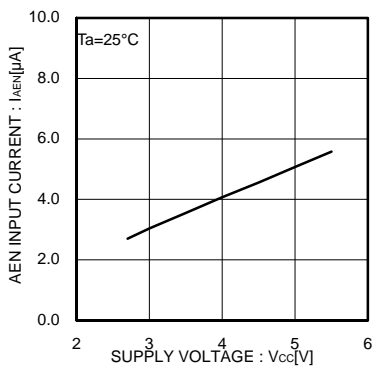

Fig.9 AEN Input Current

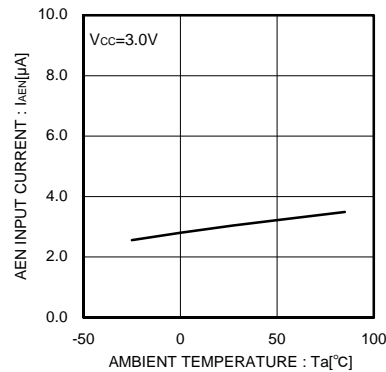

Fig.10 AEN Input Current

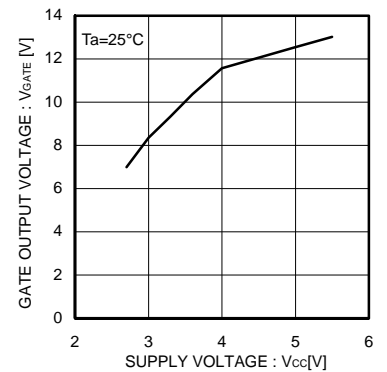

Fig.11 GATE Output Voltage

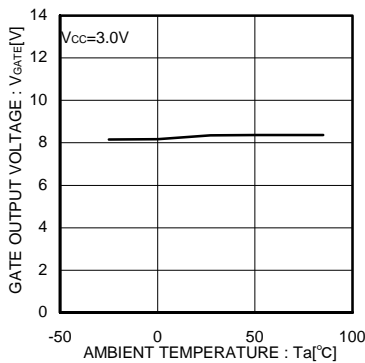

Fig.12 GATE Output Voltage

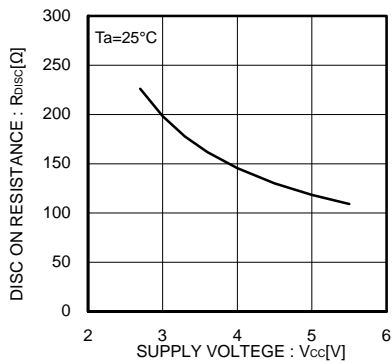

Fig.13 DISC ON Resistance

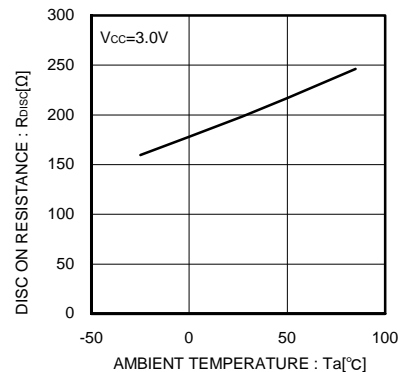

Fig.14 DISC ON Resistance

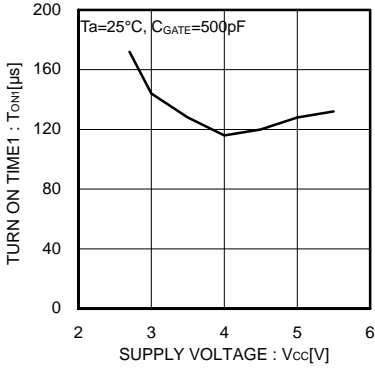

Fig.15 GATE Rise Time 1

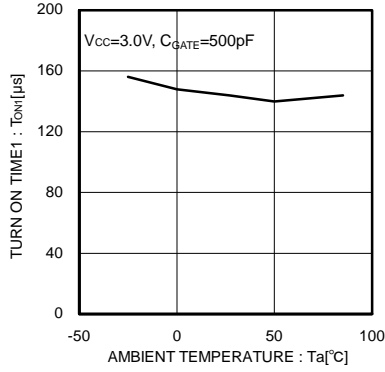

Fig.16 GATE Rise Time 1

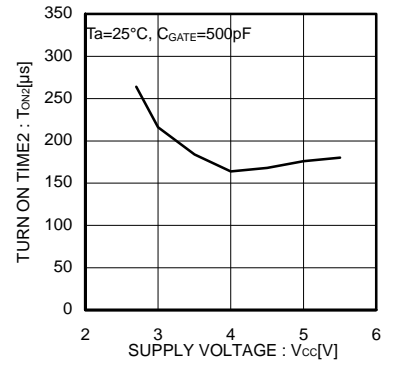

Fig.17 GATE Rise Time 2

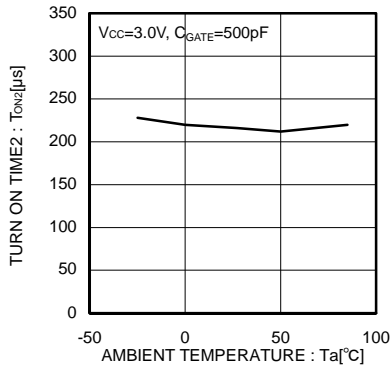

Fig.18 GATE Rise Time 2

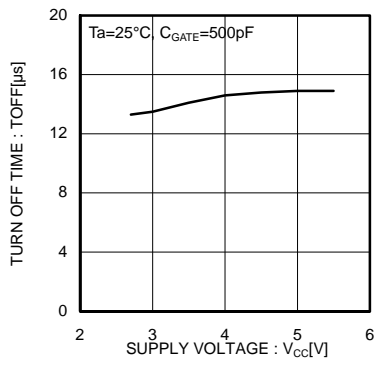

Fig.19 GATE Fall Time

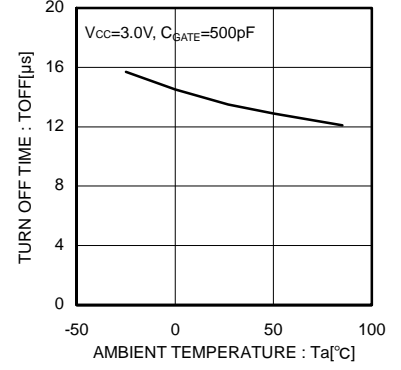

Fig.20 GATE Fall Time

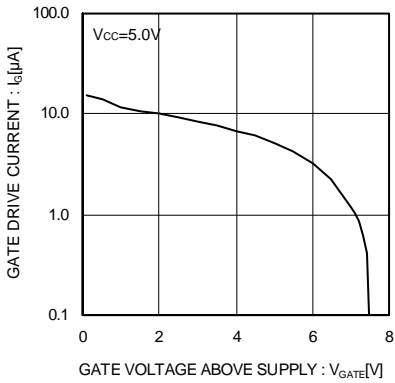

Fig.21 GATE Drive Current

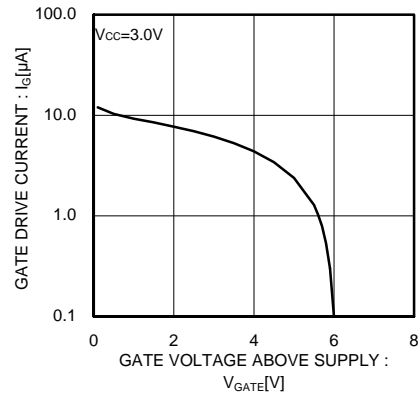

Fig.22 GATE Drive Current

•Waveform Data

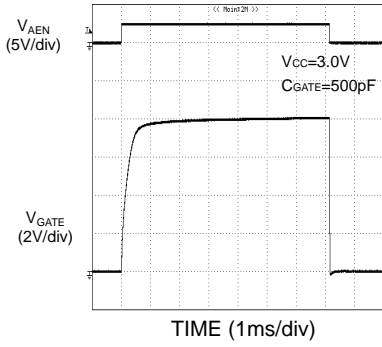

Fig.23 GATE Rise / Fall Characteristics

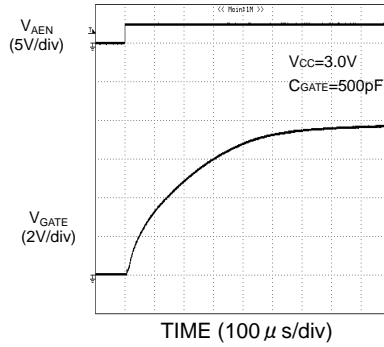

Fig.24 GATE Rise Characteristics

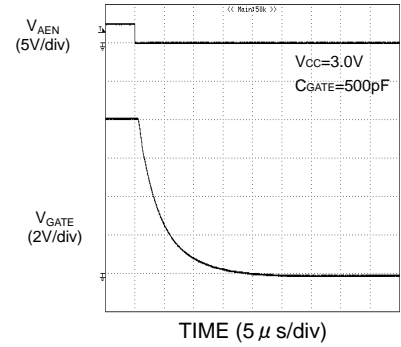

Fig.25 GATE Fall Characteristics

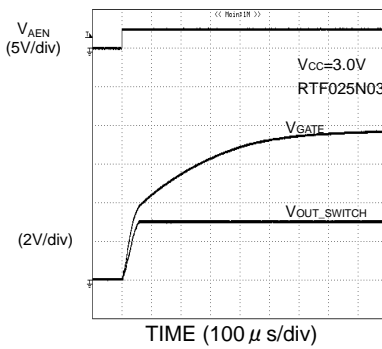

Fig.26 GATE Switch Rise Characteristics

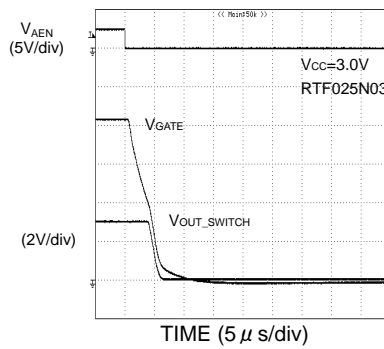

Fig.27 GATE Switch Fall Characteristics

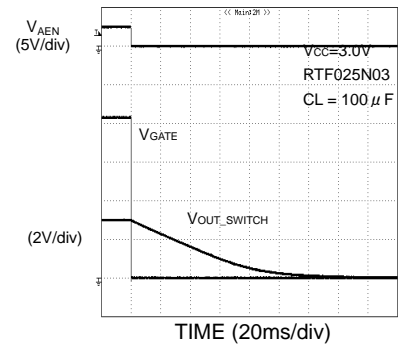

Fig.28 GATE Switch Fall Characteristics

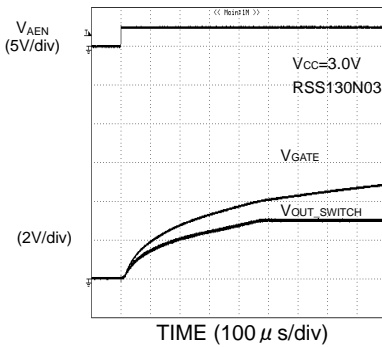

Fig.29 GATE Switch Rise Characteristics

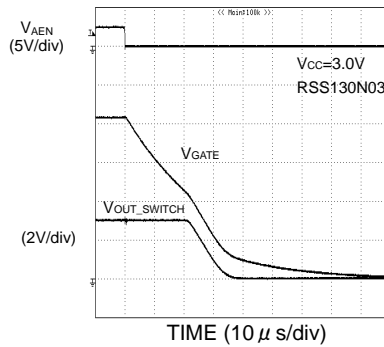

Fig.30 GATE Switch Fall Characteristics

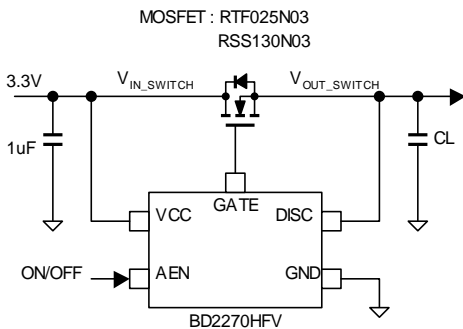

Fig.31 Switch Rise / Fall Characteristics Measurement Circuit Diagram

●Block Diagram

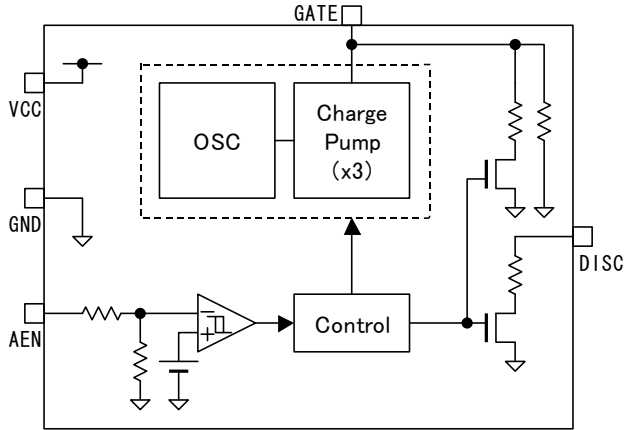

Fig.32 Block Diagram

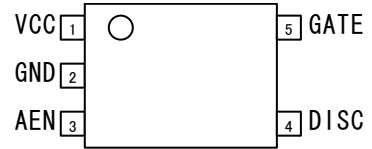

Fig.33 Pin Configuration

●Pin description

PIN No.	PIN name	I / O	Function
1	VCC	-	Power input terminal
2	GND	-	Ground terminal
3	AEN	I	Control input terminal Turn ON the external MOSFET switch with high level input. High level input > 2.0V, Low level input < 0.8V
4	DISC	O	Switch output discharge terminal
5	GATE	O	GATE drive output terminal Used to connect the gate of the external N-channel MOSFET.

●I/O circuit

Pin name	Pin No.	Equivalent circuit
AEN	3	
DISC	4	
GATE	5	

•Functional Description

The BD2270HFV is a driver IC to use an N-channel MOSFET as a high side load switch. This IC incorporates the following functions.

1. GATE drive

A voltage to drive the gate of N-channel MOSFET is generated by a built-in charge pump in the BD2270HFV. The built-in charge pump in the BD2270HFV generates a voltage three times as high as the power supply voltage at the GATE terminal. In addition, since this IC has a built-in capacitor for the charge pump, it needs no external parts.

The charge pump operates when the AEN is set to High. When the AEN is set to Low, the GATE terminal voltage is fixed to the GND level.

2. Output discharge circuit

The output discharge circuit is enabled when the AEN is set to Low. When the discharge circuit is activated, the 200Ω(Typ.) MOSFET switch located between the DISC terminal and the GND terminal turns ON. Connecting between the DISC terminal and the source side (load side) of the N-channel MOSFET makes it possible to immediately discharge capacitive load.

3. Soft start function

When the AEN terminal input voltage reaches the High level, the built-in charge pump in the BD2270HFV charges the gate of the N-channel MOSFET. The turn-on time of the N-channel MOSFET is determined by the GATE capacity. In addition, connecting a capacitor to the GATE terminal makes it possible to slow the rise of turn-on time of the N-channel MOSFET, thus achieving reduction of the inrush current to a large capacitive load.

4. Analog control input terminal

The AEN input of the BD2270HFV is connected to the built-in hysteresis comparator. Consequently, even analog signals can control the BD2270HFV, thus facilitating the control of the switch ON-OFF sequence.

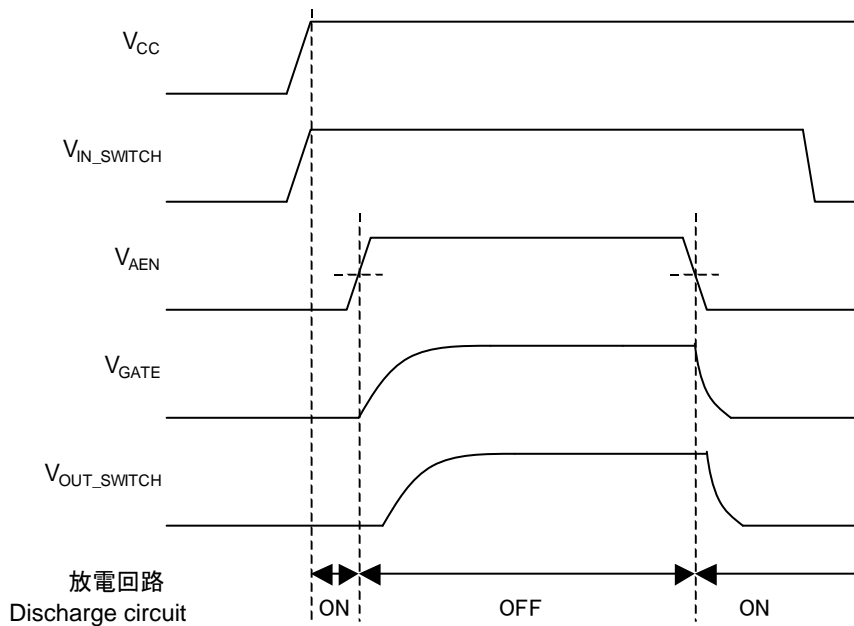

Fig. 34 Operation Timing

* To turn ON the power supply (V_{CC} , V_{IN_SWITCH}), set the AEN to Low.

•Application Circuit

1. Configuration of 3.3V load switch

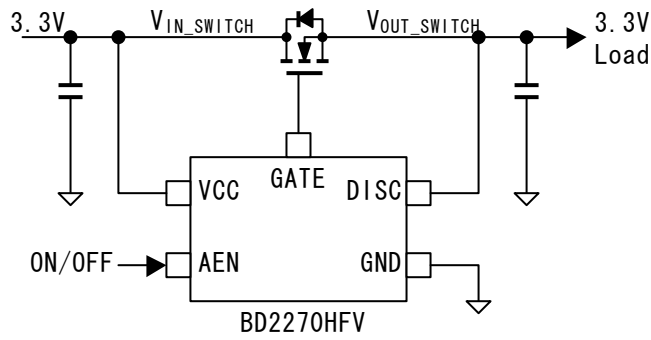

Fig.35 Configuration of 3.3V Load Switch

2. Configuration of 5V load switch

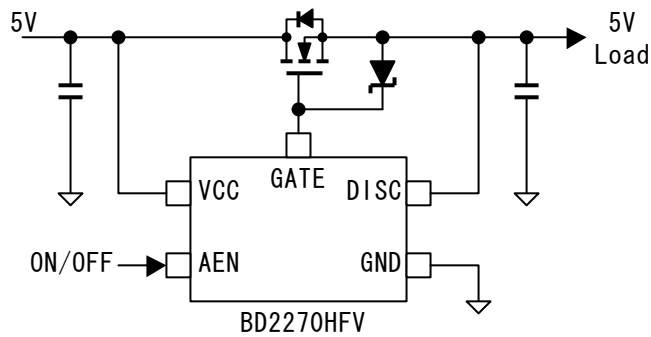

Fig.36 Configuration of 5V Load Switch

A 5V load switch can be configured like the 3.3V load switch. However, if the external N-channel MOSFET is low VGSS, clamp it with Zener diode and the like.

3. Configuration of low-voltage load switch

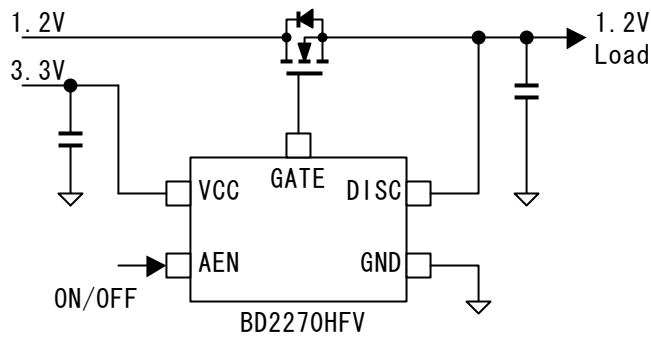

Fig.37 Configuration of Low-voltage Load Switch

Providing BD2270HFV drive power supply enables configuration of a low-voltage load switch.

4. Soft start configuration

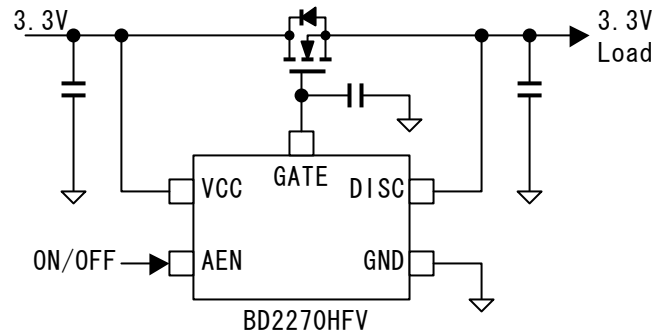

Fig.38 Soft Start Configuration

Connecting an external capacitor to the GATE terminal of the BD2270HFV makes it possible to slow the rise of the N-channel MOSFET, thus achieving reduction of the inrush current to the large-capacity capacitor mounted on the load side.

- Application Information

This system connection diagram gives no warranty to the operation as application.

To change the external circuit constant or else and use this IC, determine the application allowing for an adequate margin with consideration given to variations in external parts and ICs including not only static characteristics but also transient characteristics.

●Thermal Derating Characteristics

(HVSOF5)

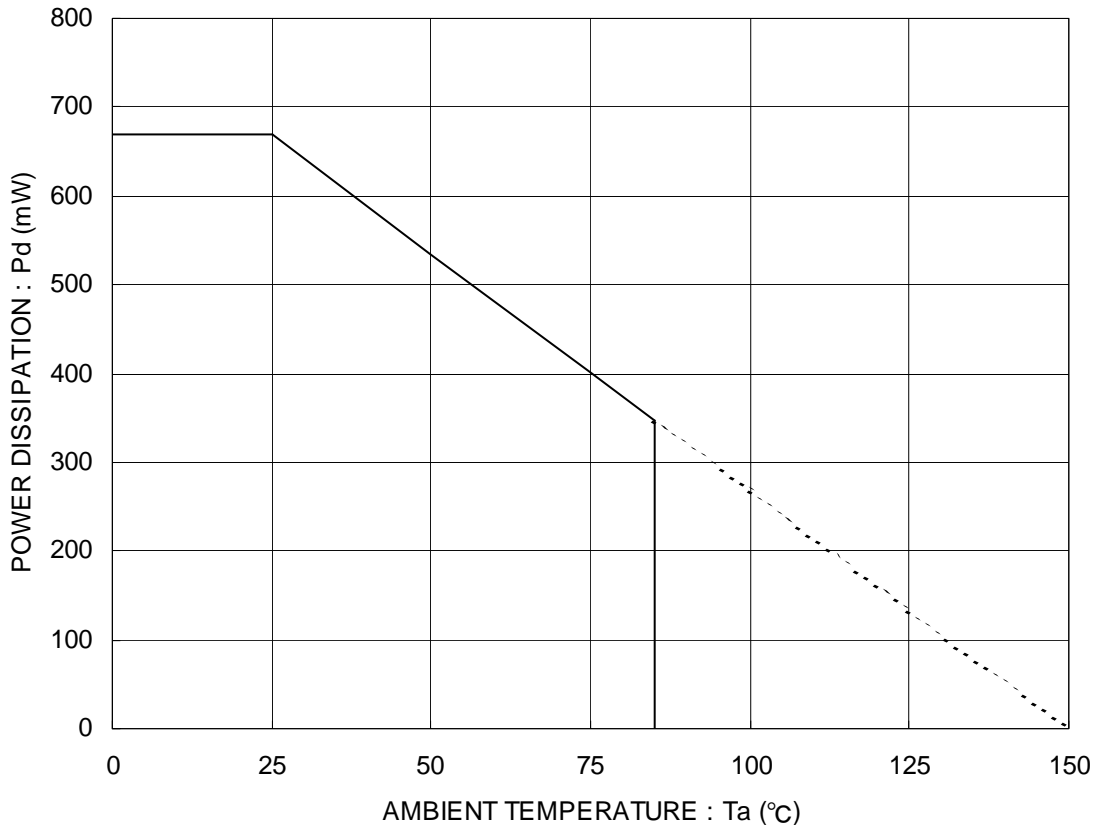

Fig. 39 Power dissipation curve (Pd-Ta Curve)
Mounted on a 70 mm×70 mm×1.6 mm glass epoxy PCB

●Cautions on use

(1) Absolute Maximum Ratings

An excess in the absolute maximum ratings, such as supply voltage, temperature range of operating conditions, etc., can break down devices, thus making impossible to identify breaking mode such as a short circuit or an open circuit. If any special mode exceeding the absolute maximum ratings is assumed, consideration should be given to take physical safety measures including the use of fuses, etc.

(2) Operating conditions

These conditions represent a range within which characteristics can be provided approximately as expected. The electrical characteristics are guaranteed under the conditions of each parameter.

(3) Reverse connection of power supply connector

The reverse connection of power supply connector can break down ICs. Take protective measures against the breakdown due to the reverse connection, such as mounting an external diode between the power supply and the IC's power supply terminal.

(4) Power supply line

Design PCB pattern to provide low impedance for the wiring between the power supply and the GND lines. In this regard, for the digital block power supply and the analog block power supply, even though these power supplies has the same level of potential, separate the power supply pattern for the digital block from that for the analog block, thus suppressing the diffraction of digital noises to the analog block power supply resulting from impedance common to the wiring patterns. For the GND line, give consideration to design the patterns in a similar manner.

Furthermore, for all power supply terminals to ICs, mount a capacitor between the power supply and the GND terminal. At the same time, in order to use an electrolytic capacitor, thoroughly check to be sure the characteristics of the capacitor to be used present no problem including the occurrence of capacity dropout at a low temperature, thus determining the constant.

- (5) GND voltage
Make setting of the potential of the GND terminal so that it will be maintained at the minimum in any operating state. Furthermore, check to be sure no terminals are at a potential lower than the GND voltage including an actual electric transient.
- (6) Short circuit between terminals and erroneous mounting
In order to mount ICs on a set PCB, pay thorough attention to the direction and offset of the ICs. Erroneous mounting can break down the ICs. Furthermore, if a short circuit occurs due to foreign matters entering between terminals or between the terminal and the power supply or the GND terminal, the ICs can break down.
- (7) Operation in strong electromagnetic field
Be noted that using ICs in the strong electromagnetic field can malfunction them.
- (8) Inspection with set PCB
On the inspection with the set PCB, if a capacitor is connected to a low-impedance IC terminal, the IC can suffer stress. Therefore, be sure to discharge from the set PCB by each process. Furthermore, in order to mount or dismount the set PCB to/from the jig for the inspection process, be sure to turn OFF the power supply and then mount the set PCB to the jig. After the completion of the inspection, be sure to turn OFF the power supply and then dismount it from the jig. In addition, for protection against static electricity, establish a ground for the assembly process and pay thorough attention to the transportation and the storage of the set PCB.
- (9) Input terminals
In terms of the construction of IC, parasitic elements are inevitably formed in relation to potential. The operation of the parasitic element can cause interference with circuit operation, thus resulting in a malfunction and then breakdown of the input terminal. Therefore, pay thorough attention not to handle the input terminals, such as to apply to the input terminals a voltage lower than the GND respectively, so that any parasitic element will operate. Furthermore, do not apply a voltage to the input terminals when no power supply voltage is applied to the IC. In addition, even if the power supply voltage is applied, apply to the input terminals a voltage lower than the power supply voltage or within the guaranteed value of electrical characteristics.
- (10) Ground wiring pattern
If small-signal GND and large-current GND are provided, It will be recommended to separate the large-current GND pattern from the small-signal GND pattern and establish a single ground at the reference point of the set PCB so that resistance to the wiring pattern and voltage fluctuations due to a large current will cause no fluctuations in voltages of the small-signal GND. Pay attention not to cause fluctuations in the GND wiring pattern of external parts as well.
- (11) External capacitor
In order to use a ceramic capacitor as the external capacitor, determine the constant with consideration given to a degradation in the nominal capacitance due to DC bias and changes in the capacitance due to temperature, etc.
- (12) Thermal design Perform thermal design in which there are adequate margins by taking into account the power dissipation (Pd) in actual states of use.

●Order type name selection

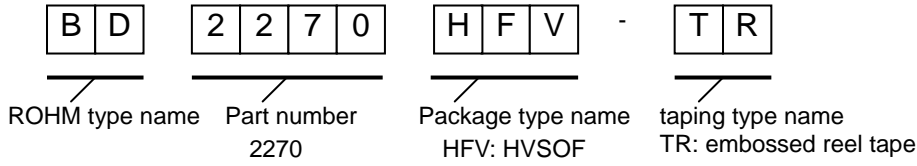

HVSO5

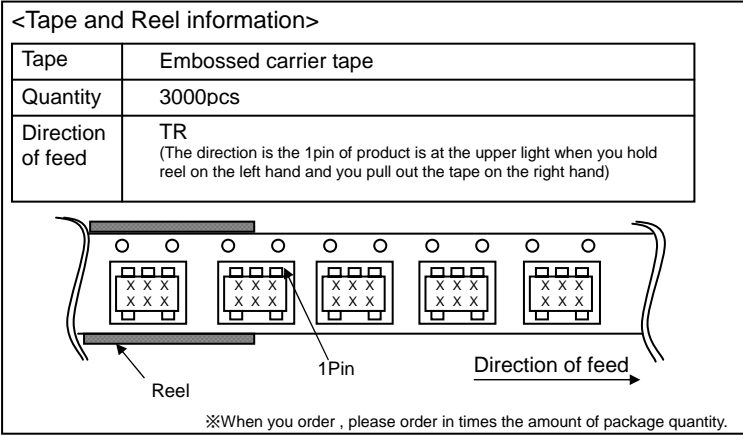
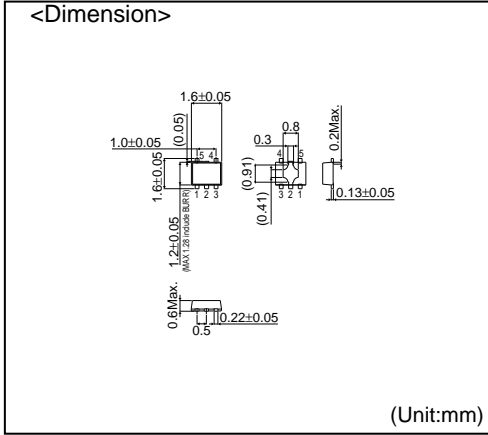

Notes

No copying or reproduction of this document, in part or in whole, is permitted without the consent of ROHM Co.,Ltd.

The content specified herein is subject to change for improvement without notice.

The content specified herein is for the purpose of introducing ROHM's products (hereinafter "Products"). If you wish to use any such Product, please be sure to refer to the specifications, which can be obtained from ROHM upon request.

Examples of application circuits, circuit constants and any other information contained herein illustrate the standard usage and operations of the Products. The peripheral conditions must be taken into account when designing circuits for mass production.

Great care was taken in ensuring the accuracy of the information specified in this document. However, should you incur any damage arising from any inaccuracy or misprint of such information, ROHM shall bear no responsibility for such damage.

The technical information specified herein is intended only to show the typical functions of and examples of application circuits for the Products. ROHM does not grant you, explicitly or implicitly, any license to use or exercise intellectual property or other rights held by ROHM and other parties. ROHM shall bear no responsibility whatsoever for any dispute arising from the use of such technical information.

The Products specified in this document are intended to be used with general-use electronic equipment or devices (such as audio visual equipment, office-automation equipment, communication devices, electronic appliances and amusement devices).

The Products specified in this document are not designed to be radiation tolerant.

While ROHM always makes efforts to enhance the quality and reliability of its Products, a Product may fail or malfunction for a variety of reasons.

Please be sure to implement in your equipment using the Products safety measures to guard against the possibility of physical injury, fire or any other damage caused in the event of the failure of any Product, such as derating, redundancy, fire control and fail-safe designs. ROHM shall bear no responsibility whatsoever for your use of any Product outside of the prescribed scope or not in accordance with the instruction manual.

The Products are not designed or manufactured to be used with any equipment, device or system which requires an extremely high level of reliability the failure or malfunction of which may result in a direct threat to human life or create a risk of human injury (such as a medical instrument, transportation equipment, aerospace machinery, nuclear-reactor controller, fuel-controller or other safety device). ROHM shall bear no responsibility in any way for use of any of the Products for the above special purposes. If a Product is intended to be used for any such special purpose, please contact a ROHM sales representative before purchasing.

If you intend to export or ship overseas any Product or technology specified herein that may be controlled under the Foreign Exchange and the Foreign Trade Law, you will be required to obtain a license or permit under the Law.



Thank you for your accessing to ROHM product informations.
More detail product informations and catalogs are available, please contact us.

ROHM Customer Support System

<http://www.rohm.com/contact/>