

Technical Data Sheet(Preliminary)**TOP View LEDs****67-21SUGC/B067/TR8****Features**

- P-LCC-2 package.
- White package.
- Optical indicator.
- Colorless clear window.
- Wide viewing angle.
- Suitable for vapor-phase reflow, Infrared reflow and wave solder processes.
- Computable with automatic placement equipment.
- Available on tape and reel (8mm Tape).
- Pb-free.
- The product itself will remain within RoHS compliant version.
- Preconditioning: acc. to JEDEC Level 2
- ESD: up to 2KV acc. to JESD22-A114-B

**Descriptions**

- The 67-21 series is available in soft orange, green, blue and yellow. Due to the package design, the LED has wide viewing angle and optimized light coupling by inter reflector. This feature makes ideal for light pipe application. The low current requirement makes this device ideal for portable equipment or any other application where power is at a premium.

Applications

- Automotive: backlighting in dashboard and switch.
- Telecommunication: indicator and backlighting in telephone and fax.
- Flat backlight for LCD, switch and symbol.
- Light pipe application.
- General use.

Device Selection Guide

Chip		Lens Color
Material	Emitted Color	
InGaN/SiC	Brilliant Green	Water Clear

Package Dimensions

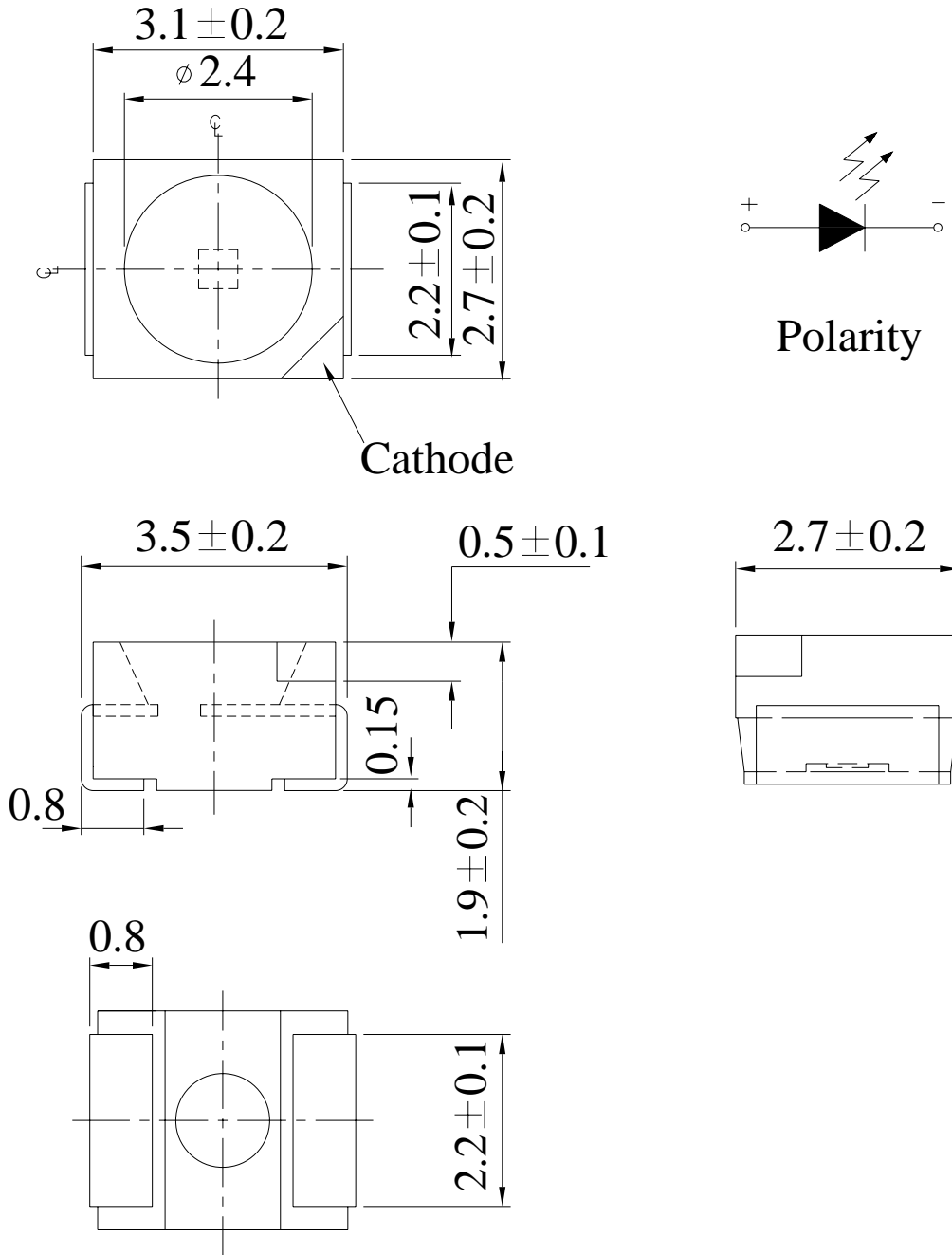

Note: The tolerances unless mentioned is ± 0.1 mm ,Unit = mm

67-21SUGC/B067/TR8

Absolute Maximum Ratings (Ta=25°C)

Parameter	Symbol	Rating	Unit
Reverse Voltage	V _R	12	V
Forward Current	I _F	30	mA
Peak Forward Current (t _p ≤ 10 μs , duty ≤ 0.005)	I _{FP}	100	mA
Power Dissipation	P _d	80	mW
Junction Temperature	T _j	100	°C
Operating Temperature	T _{opr}	-40 ~ +100	°C
Storage Temperature	T _{stg}	-40~ +110	°C
Soldering Temperature	T _{sol}	Reflow Soldering : 260 °C for 10 sec. Hand Soldering : 350 °C for 3 sec.	

Electro-Optical Characteristics (Ta=25°C)

Parameter	Symbol	Min.	Typ.	Max.	Unit	Condition
Luminous Intensity	I _v	75	-----	320	mcd	I _F =20mA
Viewing Angle	2 θ 1/2	-----	120	-----	deg	I _F =20mA
Peak Wavelength	λ _p	-----	518	-----	nm	I _F =20mA
Dominant Wavelength	λ _d	523	-----	535	nm	I _F =20mA
Spectrum Radiation Bandwidth	Δ λ	-----	36	-----	nm	I _F =20mA
Forward Voltage	V _F	2.6	-----	3.8	V	I _F =20mA
Reverse Current	I _R	-----	-----	10	μ A	V _R =12V

- Notes:**
- 1.Tolerance of Luminous Intensity ±11%
 - 2.Tolerance of Dominant Wavelength ±1nm
 - 3.Tolerance of Forward Voltage ±0.1V

67-21SUGC/B067/TR8**Bin Range Of Luminous Intensity**

Bin	Min	Max	Unit	Condition
Q2	90	112	mcd	I _F =20mA
R1	112	140		
R2	140	180		
S1	180	224		
S2	224	280		

Notes:

1.Tolerance of Luminous Intensity $\pm 11\%$

Typical Electro-Optical Characteristics Curves

Typical curve of spectral distribution:

$V(\lambda)$ =Standard eye response curve

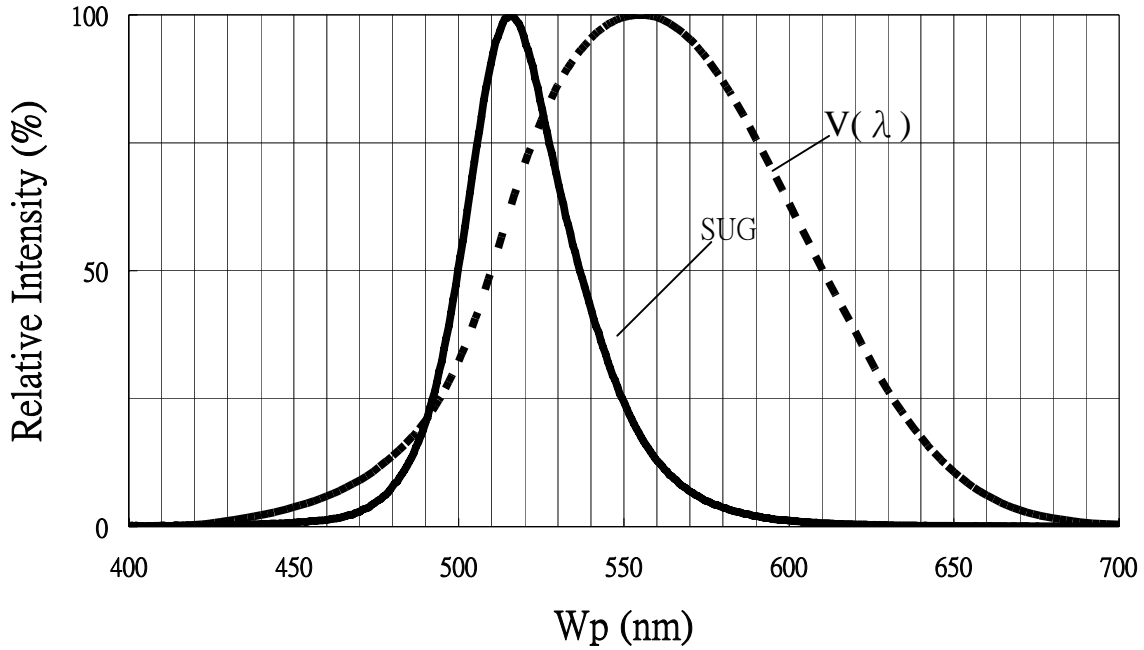
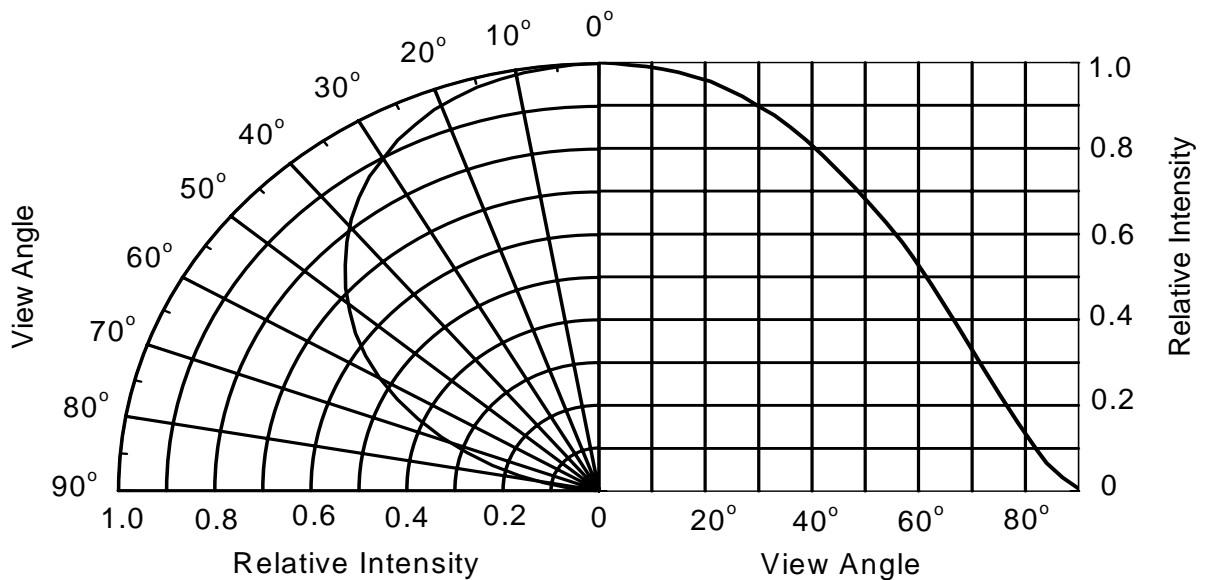
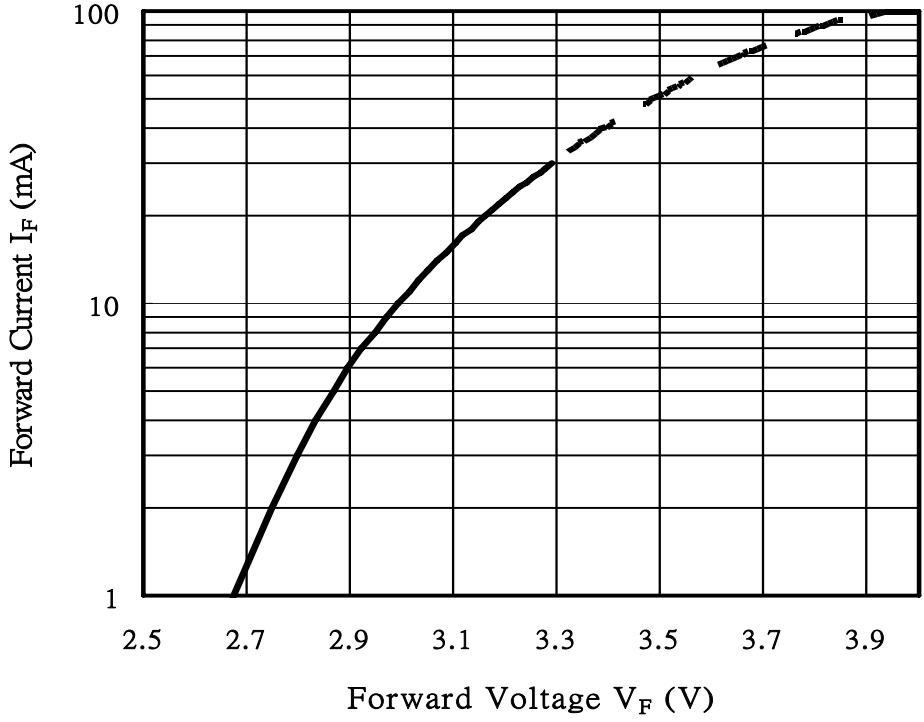

Diagram characteristics of radiation:



Forward Current vs. Forward Voltage Ta=25°C



Forward current v.s. ambient temp.

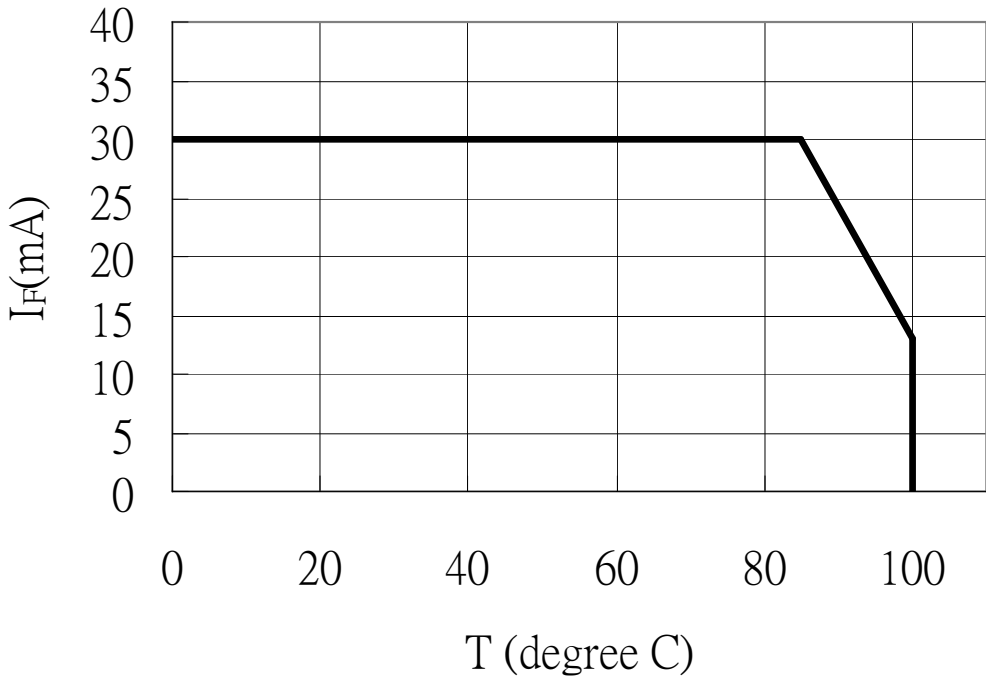

67-21SUGC/B067/TR8

Label explanation

CAT: Luminous Intensity Rank

HUE: Dom. Wavelength Rank

REF: Forward Voltage Rank

EVERLIGHT

CPN :
P/N: XXXXXXXXXXXX



RoHS

XX-XXXXXXXX

QTY: XXXX CAT: XX



HUE: XX

REF:

LOT NO: XXXXXXXXXXX



MADE IN TAIWAN

Reel Dimensions

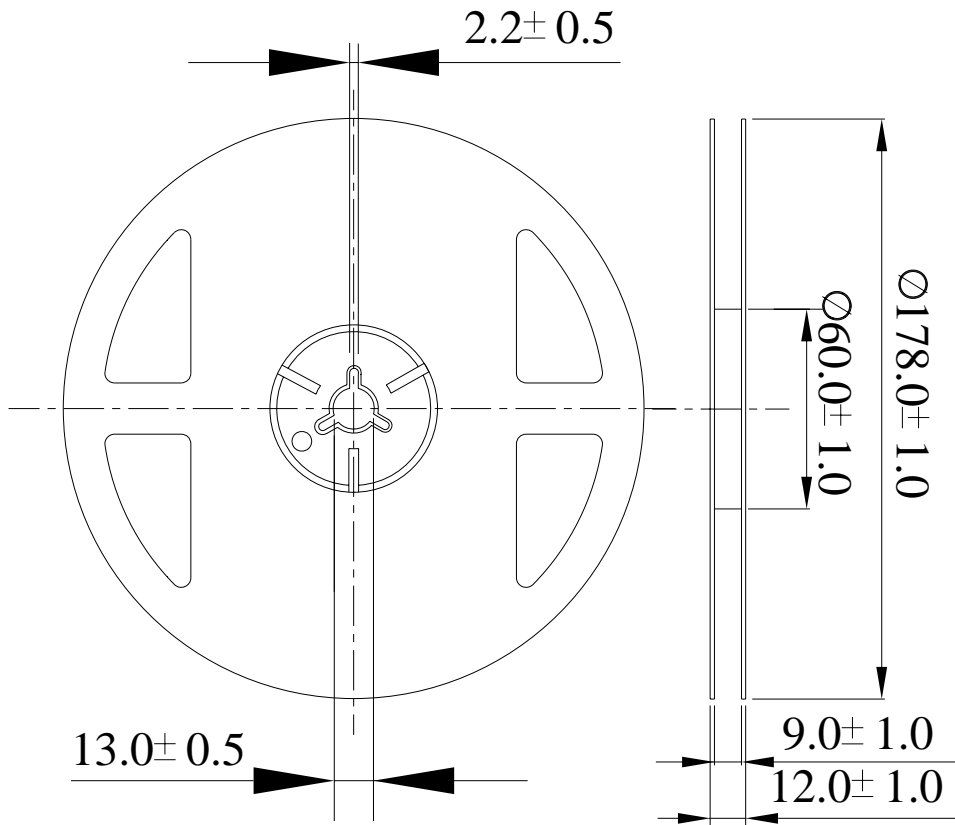

Note: The tolerances unless mentioned is ± 0.1 mm ,Unit = mm

Carrier Tape Dimensions: Loaded quantity 2000 PCS per reel.

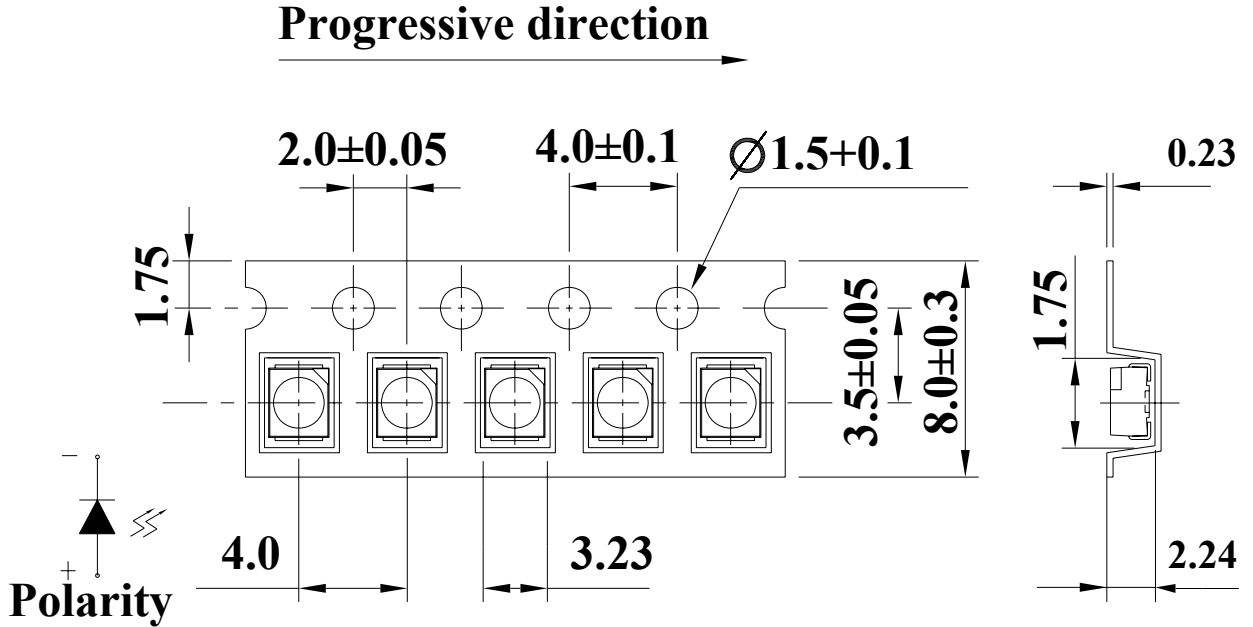

Note: The tolerances unless mentioned is $\pm 0.1\text{mm}$

Moisture Resistant Packaging

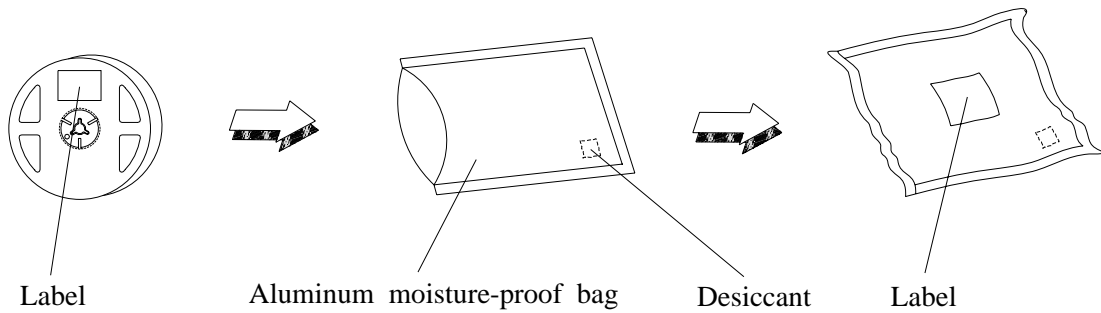

Precautions For Use

1. Over-current-proof

Customer must apply resistors for protection, otherwise slight voltage shift will cause big current change (Burn out will happen).

2. Storage

- 2.1 Do not open moisture proof bag before the products are ready to use.
- 2.2 Before opening the package: The LEDs should be kept at 30°C or less and 90%RH or less.
- 2.3 After opening the package: The LED's floor life is 1 year under 30 deg C or less and 60% RH or less.
If unused LEDs remain, it should be stored in moisture proof packages.
- 2.4 If the moisture absorbent material (silica gel) has faded away or the LEDs have exceeded the storage time, baking treatment should be performed using the following conditions.
Baking treatment : 60±5°C for 24 hours.

3. Soldering Condition

3.1 A. Pb-free solder temperature profile

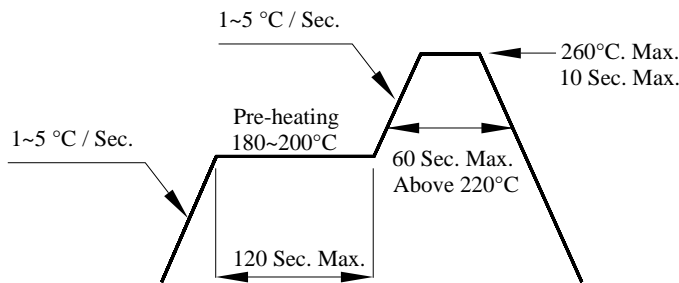

B. Recommend soldering pad

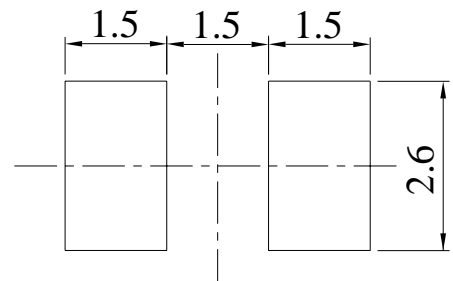

- 3.2 Reflow soldering should not be done more than two times.
- 3.3 When soldering, do not put stress on the LEDs during heating.
- 3.4 After soldering, do not warp the circuit board.

4.Soldering Iron

Each terminal is to go to the tip of soldering iron temperature less than 350°C for 3 seconds within once in less than the soldering iron capacity 25W. Leave two seconds and more intervals, and do soldering of each terminal. Be careful because the damage of the product is often started at the time of the hand solder.