

HR930.5

930.5MHz One-Port SAW Resonator



Approved by:
Checked by:
Issued by:

SPECIFICATION

PRODUCT: SAW RESONATOR

MODEL: HR930.5 TO-39

HOPE MICROELECTRONICS CO., LIMITED

The HR930.5 is a true one-port, surface-acoustic-wave (SAW) resonator in a low-profile metal TO-39 case. It provides reliable, fundamental-mode, quartz frequency stabilization i.e. in transmitters or local oscillators operating at 930.500 MHz.

1.Package Dimension (TO-39)

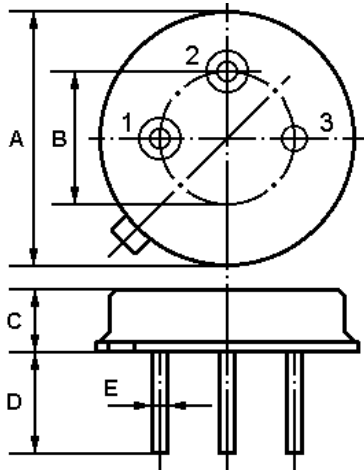

Pin	Configuration
1	Input / Output
2	Output / Input
3	Case Ground

Dimension	Data (unit: mm)
A	9.30±0.20
B	5.08±0.10
C	3.40±0.20
D	3±0.20 / 5±0.20
E	0.45±0.20

2.Marking

HR930.5

Color: Black or Blue

3.Equivalent LC Model and Test Circuit

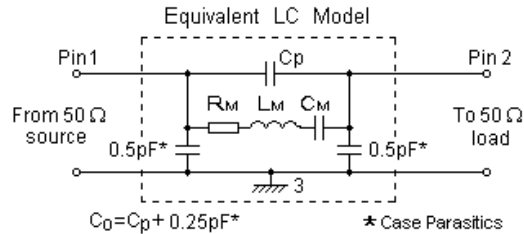

4.Typical Application Circuits

1) Low-Power Transmitter Application

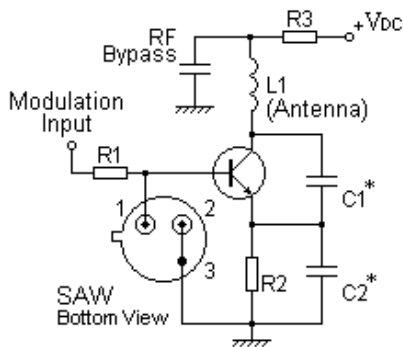

2) Local Oscillator Application

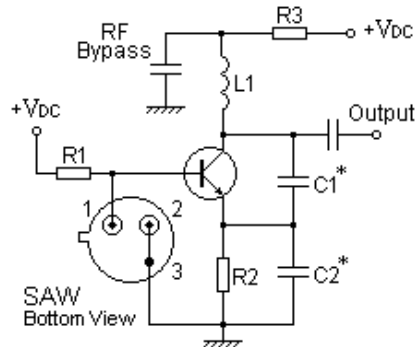

5.Typical Frequency Response

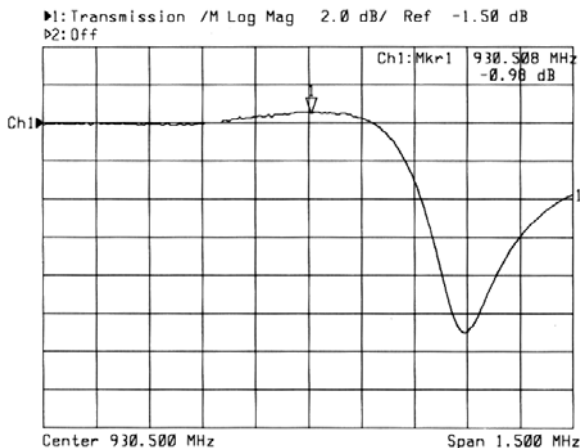

6.Temperature Characteristics

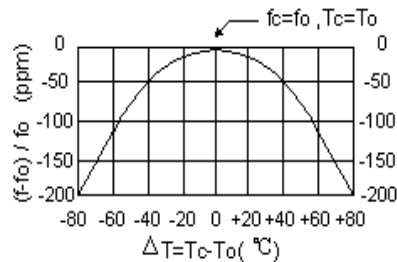

The curve shown above accounts for resonator contribution only and does not include oscillator temperature characteristics.

7.Performance

7-1.Maximum Ratings

Rating	Value	Unit
CW RF Power Dissipation P	0	dBm
DC Voltage Between Any two Pins V_{DC}	± 30	V
Storage Temperature Range T_{stg}	-40 to +85	
Operating Temperature Range T_A	-10 to +60	

7-2.Electronic Characteristics

Characteristic		Sym	Minimum	Typical	Maximum	Unit
Center Frequency (+25 °C)	Absolute Frequency	f_c	930.350		930.650	MHz
	Tolerance from 930.500MHz	Δf_c		± 150		kHz
Insertion Loss		IL		1.3	1.8	dB
Quality Factor	Unloaded Q	Q_U		11,600		
	50 Ω Loaded Q	Q_L		1,600		
Temperature Stability	Turnover Temperature	T_0	25		55	
	Turnover Frequency	f_0		f_c		kHz
	Frequency Temperature Coefficient	FTC		0.032		ppm/ °C
Frequency Aging	Absolute Value during the First Year	$ f_A $		10		ppm/yr
DC Insulation Resistance Between Any Two Pins			1.0			M Ω
RF Equivalent RLC Model	Motional Resistance	R_M		16	23	Ω
	Motional Inductance	L_M		31.7616		μ H
	Motional Capacitance	C_M		0.9220		fF
	Pin 1 to Pin 2 Static Capacitance	C_0	2.35	2.65	2.95	pF

ⓘ CAUTION: Electrostatic Sensitive Device. Observe precautions for handling!

C 2003. All Rights Reserved.

- The center frequency, f_c , is measured at the minimum IL point with the resonator in the 50 Ω test system.
- Unless noted otherwise, case temperature $T_C = +25^\circ\text{C} \pm 2^\circ\text{C}$.
- Frequency aging is the change in f_c with time and is specified at +65°C or less. Aging may exceed the specification for prolonged temperatures above +65°C. Typically, aging is greatest the first year after manufacture, decreasing in subsequent years.
- Turnover temperature, T_0 , is the temperature of maximum (or turnover) frequency, f_0 . The nominal frequency at any case temperature, T_C , may be calculated from: $f = f_0 [1 - \text{FTC} (T_0 - T_C)^2]$.
- This equivalent RLC model approximates resonator performance near the resonant frequency and is provided for reference only. The capacitance C_0 is the measured static (nonmotional) capacitance between Pin1 and Pin2. The measurement includes case parasitic capacitance.
- Derived mathematically from one or more of the following directly measured parameters: f_c , IL, 3 dB bandwidth, f_c versus T_C , and C_0 .
- The specifications of this device are based on the test circuit shown above and subject to change or obsolescence without notice.
- Typically, equipment utilizing this device requires emissions testing and government approval, which is the responsibility of the equipment manufacturer.
- Our liability is only assumed for the Surface Acoustic Wave (SAW) component(s) per se, not for applications, processes and circuits implemented within components or assemblies.
- For questions on technology, prices and delivery, please contact our sales offices or e-mail sales@hoperf.com.