

**PLEASE CHECK WWW.MOLEX.COM FOR LATEST PART INFORMATION**

**Part Number:** [0901522134](#)  
**Status:** **Active**  
**Overview:** [cgrid\\_sl\\_products](#)  
**Description:** 2.54mm (.100") Pitch C-Grid III™ PC Board Connector, Dual Row, Right Angle, Straight PCB Pins 1.0µm (40µ") Tin (Sn), 34 Circuits

**Documents:**

[3D Model](#) [RoHS Certificate of Compliance \(PDF\)](#)  
[Drawing \(PDF\)](#)

**General**

Product Family	PCB Receptacles
Series	<a href="#">90152</a>
Application	Board-to-Board
Overview	<a href="#">cgrid_sl_products</a>
Product Name	C-Grid III™

**Physical**

Circuits (Loaded)	34
Color - Resin	Black
Glow-Wire Compliant	No
Guide to Mating Part	No
Keying to Mating Part	None
Lock to Mating Part	No
Material - Metal	Phosphor Bronze
Material - Plating Mating	Tin
Material - Plating Termination	Tin
Material - Resin	Polyester
Number of Rows	2
Orientation	Right Angle
PC Tail Length (in)	0.114 In
PC Tail Length (mm)	2.90 mm
PCB Locator	No
PCB Retention	None
PCB Thickness Recommended (in)	0.062 In
PCB Thickness Recommended (mm)	1.60 mm
Packaging Type	Tube
Pitch - Mating Interface (in)	0.100 In
Pitch - Mating Interface (mm)	2.54 mm
Plating min: Mating (µin)	40
Plating min: Mating (µm)	1.00
Plating min: Termination (µin)	40
Plating min: Termination (µm)	1.00
Polarized to PCB	No
Temperature Range - Operating	-55°C to +125°C
Termination Interface: Style	Through Hole

**Electrical**

Current - Maximum per Contact	3A
Grounding to PCB	No
Voltage - Maximum	350V

**Material Info**

**Reference - Drawing Numbers**

Sales Drawing	SDA-90152
---------------	-----------

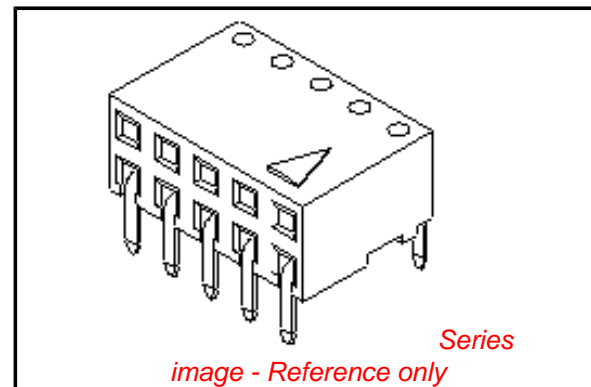

**EU RoHS**

**ELV and RoHS  
Compliant**  
**REACH SVHC  
Contains SVHC: No**  
**Halogen-Free  
Status**

**China RoHS**



**Not Reviewed**  
**Need more information on product  
environmental compliance?**

Email [productcompliance@molex.com](mailto:productcompliance@molex.com)  
 For a multiple part number RoHS Certificate of Compliance, [click here](#)

Please visit the [Contact Us](#) section for any non-product compliance questions.

**Search Parts in this Series**

[90152Series](#)

**Mates With**

[90122](#) , [90131](#)

This document was generated on 05/24/2010

**PLEASE CHECK [WWW.MOLEX.COM](http://WWW.MOLEX.COM) FOR LATEST PART INFORMATION**

TERMINAL RETENTION FEATURE



RECOMMENDED P.C. BOARD HOLE PATTERN

NOTES

- 1) CONTACT-PLATED PHOSPHOR BRONZE.
- 2) HOUSING-15% GLASS FILLED POLYESTER. COLOUR-BLACK.
- 3) COMPATABLE WITH PCB HOLE PATTERN.
- 4) THIS MARK INDICATES CIRCUIT NO.1.
- 5) FOR (0.635)/.025 SQ. MALE PINS THE LENGTH MUST BE (5.65)/.222 MIN & (7.00)/.276 MAX. TO ENSURE GOOD CONNECTION WITH CONTACT.
- 6) PRODUCT SPECIFICATION: PS-99020-0001
- 7) RECOMMENDED PCB THICKNESS 1.6MM



SEE DETAIL "A"

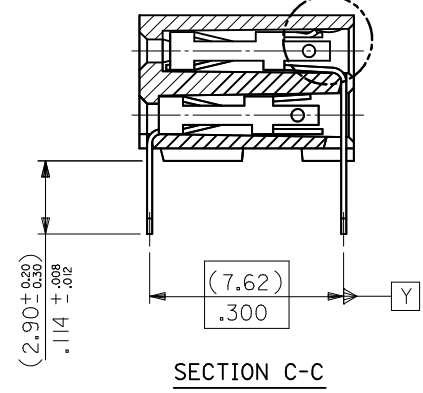

SECTION C-C

DETAIL "A"



TERMINAL RETENTION FEATURE

CHG PKG QTY FOR 4CKT EC NO: S2010-0556 DRWN:ATSEE 2010/01/12 CHKD:SKANG 2010/01/14 APPR:MLONG 2010/01/14	QUALITY SYMBOLS $F_{\Delta} = 0$ $F_{\square} = 0$ $F_{\nabla} = 0$	GENERAL TOLERANCES (UNLESS SPECIFIED) mm INCH 4 PLACES ± --- ± --- 3 PLACES ± --- ± --- 2 PLACES ± 0.20 ± .008 1 PLACE ± --- ± --- ANGULAR ± 2 °	DIMENSION STYLE MM ONLY DRAWN BY: DB DATE: 1987/07/14 CHECKED BY: DB DATE: 1987/07/14 APPROVED BY: MLONG DATE: 2010/01/14	SCALE NTS TITLE C-GRID PCB CONN DR HORZ	DESIGN UNITS METRIC THIRD ANGLE PROJECTION
	DRAFT WHERE APPLICABLE MUST REMAIN WITHIN DIMENSIONS	MATERIAL NO. SEE TABLE	MOLEX INCORPORATED DOCUMENT NO. SDA-90152	SHEET NO. 1 OF 5	
	SIZE A3	THIS DRAWING CONTAINS INFORMATION THAT IS PROPRIETARY TO MOLEX INCORPORATED AND SHOULD NOT BE USED WITHOUT WRITTEN PERMISSION			
	REV				

	10	9	8	7	6	5	4	3	2	1	
	PART NO.	CKT	DIM. A		DIM. B <sup>(+0.00)</sup> <sub>(-0.30)</sub> <sup>+0.00</sup> <sub>-0.12</sub>		PCS/ TUBE				
F	90152-XX04	4	(2.54)	.100	(5.08)	.200	109	PLATING VERSION A			
	06	6	(5.08)	.200	(7.62)	.300	73	PRE-PLATED HOT DIP TIN 1.0 TO 2.5 microns (.00004" TO .00010").			
	08	8	(7.62)	.300	(10.16)	.400	55	PLATING VERSION E			
	10	10	(10.16)	.400	(12.70)	.500	44	1.27 TO 1.78 microns (.00005" TO .00007") NICKEL OVERALL, 0.38 TO 0.64 microns (.000015" TO .000025") GOLD ON CONTACT AREA (OVER NICKEL). 3 TO 5 microns (.00012" TO .00020") TIN ON SOLDER TAILS (OVER NICKEL).			
	12	12	(12.70)	.500	(15.24)	.600	36	PLATING VERSION F			
	14	14	(15.24)	.600	(17.78)	.700	31	1.27 TO 1.78 microns (.00005" TO .00007") NICKEL OVERALL, 0.76 TO 1.0 microns (.00003" TO .00004") GOLD ON CONTACT AREA (OVER NICKEL). 3 TO 5 microns (.00012" TO .00020") TIN ON SOLDER TAILS (OVER NICKEL).			
E	16	16	(17.78)	.700	(20.32)	.800	27	PLATING VERSION G			
	18	18	(20.32)	.800	(22.86)	.900	24	1.27 TO 1.78 microns (.00005" TO .00007") NICKEL OVERALL, 0.125 TO 0.20 microns (.000005" TO .0000079") GOLD ON CONTACT AREA (OVER NICKEL). 3 TO 5 microns (.00012" TO .00020") TIN ON SOLDER TAILS (OVER NICKEL).			
	20	20	(22.86)	.900	(25.40)	1.000	22	90152 - X X Y Y			
	22	22					20	INDICATES NO. OF CIRCUITS			
	24	24	(27.94)	1.100	(30.48)	1.200	18	PLATING CODE. 21 = VERSION A 22 = VERSION E 23 = VERSION F 25 = VERSION G			
	26	26	(30.48)	1.200	(33.02)	1.300	16				
D	28	28					14				
	30	30	(35.56)	1.400	(38.10)	1.500	14				
	32	32					13				
	34	34	(40.64)	1.600	(43.18)	1.700	12				
	36	36	(43.18)	1.700	(45.72)	1.800	12				
	38	38	(45.72)	1.800	(48.26)	1.900	11				
	40	40	(48.26)	1.900	(50.80)	2.000	11				
	42	42					10				
	44	44	(53.34)	2.100	(55.88)	2.200	10				
	46	46					10				
C	48	48					9				
	50	50	(60.96)	2.400	(63.50)	2.500	8				
	52	52					8				
	54	54					8				
	56	56	(68.58)	2.700	(71.12)	2.800	7				
	58	58					7				
B	60	60	(73.66)	2.900	(76.20)	3.000	7				
	62	62					6				
	90152-XX64	64	(78.74)	3.100	(81.28)	3.200	5				

STANDARD PRODUCTS

CHG PKG QTY FOR 4CKT EC NO: S2010-0556 DRWN:ATSEE 2010/01/12 CHKD:SKANG 2010/01/14 APPR:MLONG 2010/01/14	QUALITY SYMBOLS	GENERAL TOLERANCES (UNLESS SPECIFIED)		DIMENSION STYLE		SCALE	DESIGN UNITS	THIRD ANGLE PROJECTION		
	$\nabla_A = 0$ $\nabla_C = 0$ $\nabla_P = 0$	mm	INCH	MM ONLY		NTS	METRIC			
		4 PLACES ± ---	± ---	DB	DATE	TITLE				
		3 PLACES ± ---	± ---	DB	DATE	C-GRID PCB CONN DR HORZ				
	2 PLACES ± 0.20	± .008	MLONG	DATE	MOLEX INCORPORATED					
	1 PLACE ± ---	± ---	MLONG	DATE	SDA-90152					
	ANGULAR ± 2 °		MATERIAL NO.		DOCUMENT NO.		SHEET NO.			
	DRAFT WHERE APPLICABLE MUST REMAIN WITHIN DIMENSIONS		SEE TABLE				2 OF 5			
			SIZE	THIS DRAWING CONTAINS INFORMATION THAT IS PROPRIETARY TO MOLEX INCORPORATED AND SHOULD NOT BE USED WITHOUT WRITTEN PERMISSION						



10 9 8 7 6 5 4 3 2 1

TERMINAL RETENTION FEATURE

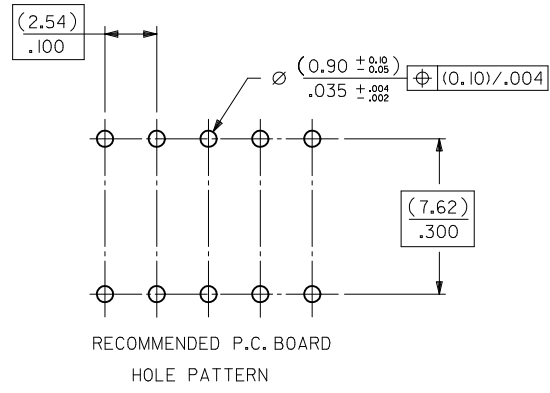
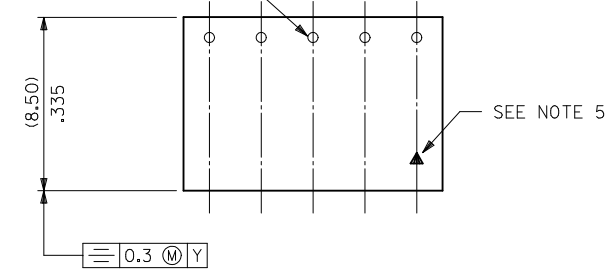

RECOMMENDED P.C. BOARD HOLE PATTERN

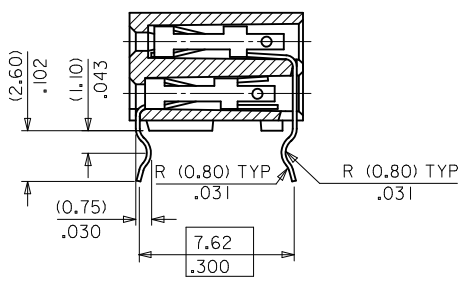
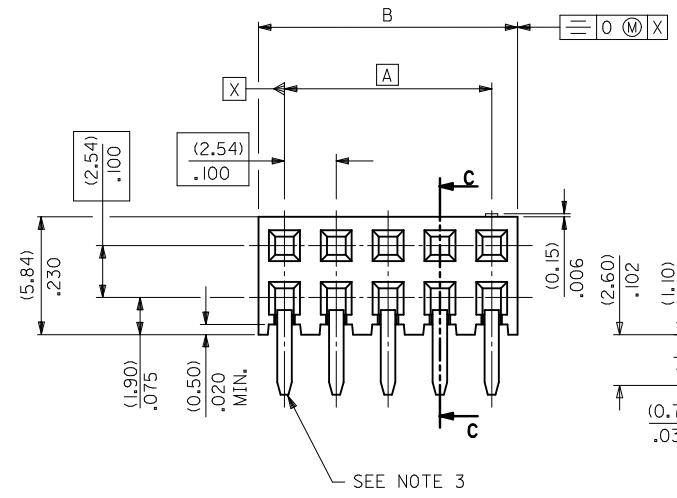

SECTION C-C

NOTES

- 1) CONTACT-PLATED PHOSPHOR BRONZE.
- 2) HOUSING-15% GLASS FILLED POLYESTER, COLOUR-BLACK.
- 3) COMPATIBLE WITH PCB HOLE PATTERN.
- 4) RECOMMENDED PC BOARD THICKNESS (1.4 ± .2) / .055 ± .008
- 5) THIS MARK INDICATES CIRCUIT NO. I.
- 6) FOR (0.635) / .025 SO. MALE PINS THE LENGTH MUST BE (5.65) / .222 MIN & (7.00) / .276 MAX. TO ENSURE GOOD CONNECTION WITH CONTACT.

DETAIL \*A\*

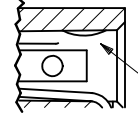

TERMINAL RETENTION FEATURE

CHG PKG QTY FOR 4CKT EC NO: S2010-0556 DRAWN/AT/SEE 2010/01/12 CHKD/SKANG 2010/01/14 APPR/MLONG 2010/01/14	QUALITY SYMBOLS	GENERAL TOLERANCES (UNLESS SPECIFIED)	DIMENSION STYLE	SCALE	DESIGN UNITS	THIRD ANGLE PROJECTION
	▽=0	mm INCH	MM ONLY	NTS	METRIC	⊙
	▽=0	4 PLACES ± --- ± ---	DRAWN BY DATE			
	▽=0	3 PLACES ± --- ± ---	DB 1987/07/14			
		2 PLACES ± 0.20 ± .008	CHECKED BY DATE			
		1 PLACE ± --- ± ---	DB 1987/07/14			
		ANGULAR ± 2 °	APPROVED BY DATE			
			MLONG 2010/01/14			
			MATERIAL NO.			

DRAFT WHERE APPLICABLE MUST REMAIN WITHIN DIMENSIONS	SEE TABLE
SIZE A3	THIS DRAWING CONTAINS INFORMATION THAT IS PROPRIETARY TO MOLEX INCORPORATED AND SHOULD NOT BE USED WITHOUT WRITTEN PERMISSION

TITLE		C-GRID PCB CONN DR HORZ	
MOLEX INCORPORATED		SDA-90152	
DOCUMENT NO.	SHEET NO.	3 OF 5	

9 8 7 6 5 4 3 2 1

	10	9	8	7	6	5	4	3	2	1
	PART NO.	CKT	DIM. A		DIM. B <sup>(+0.00/-0.30)</sup> <sub>+0.00/-0.12</sub>		PCS/TUBE			
F	90152-XX04	4	(2.54)	.100	(5.08)	.200	109			
	06	6	(5.08)	.200	(7.62)	.300	73			
	08	8	(7.62)	.300	(10.16)	.400	55			
	10	10	(10.16)	.400	(12.70)	.500	44			
	12	12	(12.70)	.500	(15.24)	.600	36			
	14	14	(15.24)	.600	(17.78)	.700	31			
	16	16	(17.78)	.700	(20.32)	.800	27			
	18	18	(20.32)	.800	(22.86)	.900	24			
E	20	20	(22.86)	.900	(25.40)	1.000	22			
	22	22					20			
	24	24	(27.94)	1.100	(30.48)	1.200	18			
	26	26	(30.48)	1.200	(33.02)	1.300	16			
	28	28					14			
	30	30	(35.56)	1.400	(38.10)	1.500	14			
	32	32					13			
	34	34	(40.64)	1.600	(43.18)	1.700	12			
D	36	36	(43.18)	1.700	(45.72)	1.800	12			
	38	38	(45.72)	1.800	(48.26)	1.900	11			
	40	40	(48.26)	1.900	(50.80)	2.000	11			
	42	42					10			
	44	44	(53.34)	2.100	(55.88)	2.200	10			
	46	46					10			
	48	48					9			
	50	50	(60.96)	2.400	(63.50)	2.500	8			
C	52	52					8			
	54	54					8			
	56	56	(68.58)	2.700	(71.12)	2.800	7			
	58	58					7			
	60	60	(73.66)	2.900	(76.20)	3.000	7			
	62	62					6			
B	90152-XX64	64	(78.74)	3.100	(81.28)	3.200	5			

PLATING VERSION A

PRE-PLATED HOT DIP TIN  
1.0 TO 2.5 microns (.00004" TO .00010").

PLATING VERSION E

1.27 TO 1.78 microns (.00005" TO .00007") NICKEL  
OVERALL, 0.38 TO 0.64 microns (.000015" TO .000025")  
GOLD ON CONTACT AREA (OVER NICKEL).  
3 TO 5 microns (.00012" TO .00020") TIN  
ON SOLDER TAILS (OVER NICKEL).

PLATING VERSION F.

1.27 TO 1.78 microns (.00005" TO .00007") NICKEL  
OVERALL, 0.76 TO 1.0 microns (.00003" TO .00004")  
GOLD ON CONTACT AREA (OVER NICKEL).  
3 TO 5 microns (.00012" TO .00020") TIN  
ON SOLDER TAILS (OVER NICKEL).

PLATING VERSION G.

1.27 TO 1.78 microns (.00005" TO .00007") NICKEL  
OVERALL, 0.125 TO 0.20 microns (.000005" TO .0000079")  
GOLD ON CONTACT AREA (OVER NICKEL).  
3 TO 5 microns (.00012" TO .00020") TIN  
ON SOLDER TAILS (OVER NICKEL).

90152-XXYY

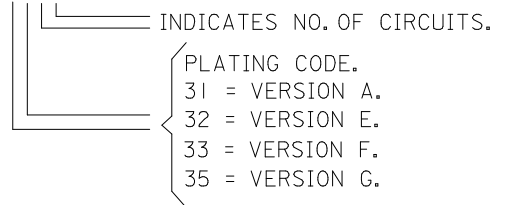

A	CHG PKG QTY FOR 4CKT EC NO: S2010-0556 DRWN:ATSEE 2010/01/12 CHKD:SKANG 2010/01/14 APPR:MLONG 2010/01/14	REV DESCRIPTION	QUALITY SYMBOLS	GENERAL TOLERANCES (UNLESS SPECIFIED)	DIMENSION STYLE		SCALE	DESIGN UNITS	THIRD ANGLE PROJECTION
					MM ONLY	NTS	METRIC		
					DRAWN BY DATE	TITLE			
					CHECKED BY DATE	C-GRID PCB CONN DR HORZ			
			ANGULAR ± 2 °	APPROVED BY DATE	MOLEX INCORPORATED				
			DRAFT WHERE APPLICABLE MUST REMAIN WITHIN DIMENSIONS	MATERIAL NO.	DOCUMENT NO.			SHEET NO.	
				SEE TABLE	SDA-90152			4 OF 5	
				SIZE A3	THIS DRAWING CONTAINS INFORMATION THAT IS PROPRIETARY TO MOLEX INCORPORATED AND SHOULD NOT BE USED WITHOUT WRITTEN PERMISSION				

PART NUMBER	CKT. SIZE	PIN VOID	KINKED PINS	NO. PER TUBE
90152-6234	2 X 17	21	NONE	12
90152-5242	2 X 21	5	NONE	10
90152-7130	2 X 15	NONE	1,2 & 29,30	14

TERMINAL RETENTION FEATURE

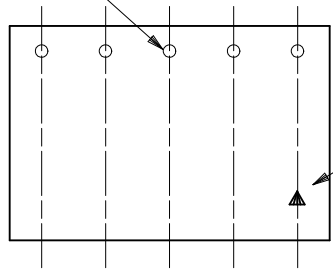

SEE NOTE 2.

NOTES

- 1) FOR DIMENSIONS SEE SHEET 1.
- 2) THIS MARK INDICATES CIRCUIT NO.1.
- 3) SOLDER TAIL OF TERMINAL IN VOIDED CAVITY MUST BE CROPPED AS SHOWN OR TERMINAL REMOVED.

90152-XXYY

INDICATES NO. OF CIRCUITS.  
 PLATING CODE.  
 1 = VERSION A.  
 2 = VERSION E.  
 3 = VERSION F.  
 5 = VERSION G.

OPTIONS  
 2 = REGULAR  
 3 = KINKED  
 5 = VOIDS  
 6 = KINKS & VOIDS  
 7 = SELECTIVE KINKS

SEE DETAIL "A"



SECTION C-C

DETAIL "A"



TERMINAL RETENTION FEATURE

CHG PKG QTY FOR 4CKT EC NO: S2010-0556 DRWN:ATSEE 2010/01/12 CHKD:SKANG 2010/01/14 APPR:MLONG 2010/01/14	DESCRIPTION REV	QUALITY SYMBOLS	GENERAL TOLERANCES (UNLESS SPECIFIED)	DIMENSION STYLE	SCALE	DESIGN UNITS	THIRD ANGLE PROJECTION
		$F_A=0$ $F_C=0$ $F_P=0$	mm    INCH 4 PLACES ± --- ± --- 3 PLACES ± --- ± --- 2 PLACES ± 0.20 ± .008 1 PLACE ± --- ± --- ANGULAR ± 2 °	MM ONLY	NTS	METRIC	
			DRAFT WHERE APPLICABLE MUST REMAIN WITHIN DIMENSIONS	DRAWN BY: DB    DATE: 1987/07/14 CHECKED BY: DB    DATE: 1987/07/14 APPROVED BY: MLONG    DATE: 2010/01/14	TITLE: C-GRID PCB CONN DR HORZ MOLEX INCORPORATED		
				MATERIAL NO.: SEE TABLE SIZE: A3	DOCUMENT NO.: SDA-90152		SHEET NO.: 5 OF 5
THIS DRAWING CONTAINS INFORMATION THAT IS PROPRIETARY TO MOLEX INCORPORATED AND SHOULD NOT BE USED WITHOUT WRITTEN PERMISSION							

SEE CHART  
SDA-90152

PART NO.	NO. OF CKTS.	DIM. A		DIM. B $\begin{matrix} (+0.00 \\ 0.30 \\ +.000 \\ -.012 \end{matrix}$		NO. PER TUBE
90152-XX04	4	( 2.54 )	.100	( 5.08 )	.200	110
▲ ▲ 06	6	( 5.08 )	.200	( 7.62 )	.300	73
08	8	( 7.62 )	.300	(10.16)	.400	55
10	10	(10.16)	.400	(12.70)	.500	44
12	12	(12.70)	.500	(15.24)	.600	36
14	14	(15.24)	.600	(17.78)	.700	31
16	16	(17.78)	.700	(20.32)	.800	27
18	18	(20.32)	.800	(22.86)	.900	24
20	20	(22.86)	.900	(25.40)	1.000	22
22	22					20
24	24	(27.94)	1.100	(30.48)	1.200	18
26	26	(30.48)	1.200	(33.02)	1.300	16
28	28					14
30	30	(35.56)	1.400	(38.10)	1.500	14
32	32					13
34	34	(40.64)	1.600	(43.18)	1.700	12
36	36	(43.18)	1.700	(45.72)	1.800	12
38	38	(45.72)	1.800	(48.26)	1.900	11
40	40	(48.26)	1.900	(50.80)	2.000	11
42	42					10
44	44	(53.34)	2.100	(55.88)	2.200	10
46	46					10
48	48					9
50	50	(60.96)	2.400	(63.50)	2.500	8
52	52					8
54	54					8
56	56	(68.58)	2.700	(71.12)	2.800	7
58	58					7
60	60	(73.66)	2.900	(76.20)	3.000	7
▼ ▼ 62	62					6
90152-XX64	64	(78.74)	3.100	(81.28)	3.200	5

PLATING VERSION A

PRE-PLATED HOT DIP TIN  
1.0 TO 2.5 microns (.00004" TO .00010").

PLATING VERSION E

1.27 TO 1.78 microns (.00005" TO .00007") NICKEL  
OVERALL, 0.38 TO 0.64 microns (.000015" TO .000025")  
GOLD ON CONTACT AREA (OVER NICKEL).  
3 TO 5 microns (.00012" TO .00020") TIN  
ON SOLDER TAILS (OVER NICKEL).

PLATING VERSION F.

1.27 TO 1.78 microns (.00005" TO .00007") NICKEL  
OVERALL, 0.76 TO 1.0 microns (.00003" TO .00004")  
GOLD ON CONTACT AREA (OVER NICKEL).  
3 TO 5 microns (.00012" TO .00020") TIN  
ON SOLDER TAILS (OVER NICKEL).

PLATING VERSION G.

1.27 TO 1.78 microns (.00005" TO .00007") NICKEL  
OVERALL, 0.125 TO 0.20 microns (.000005" TO .0000079")  
GOLD ON CONTACT AREA (OVER NICKEL).  
3 TO 5 microns (.00012" TO .00020") TIN  
ON SOLDER TAILS (OVER NICKEL).

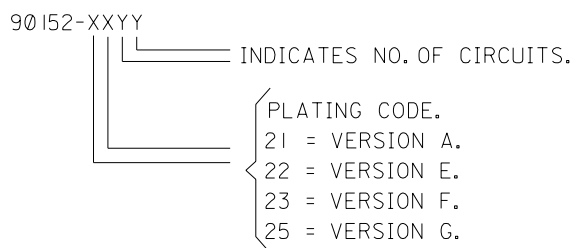

STANDARD PRODUCTS

FOR PREVIOUS DRAWING ISSUES SEE MRI.

LEAD FREE CONVERSION NEW BORDER ADDED EC NO. E2004-0610 DRWN: PSHEAHAN 08/01/2004 CHK: APPR:	QUALITY SYMBOLS MAJOR CRITICAL	GENERAL TOLERANCES: (UNLESS SPECIFIED)		SCALE 5:1	DESIGN UNITS <input checked="" type="checkbox"/> mm <input type="checkbox"/> INCH	THIRD ANGLE PROJECTION	DIMENSIONS: <input type="checkbox"/> mm <input type="checkbox"/> INCH <input type="checkbox"/> mm <input type="checkbox"/> INCH	SHT	REV	
		4 PLACES ±0.1	3 PLACES ±0.1	2 PLACES ±0.1	1 PLACE ±0.1	ANGULAR: ± °	DRAWN BY & DATE DB 14/7/87		CHECKED BY & DATE	
AD	REV	DESCRIPTION	DRAFT WHERE APPLICABLE MUST REMAIN WITHIN DIMENSIONS		APPROVED BY & DATE		TITLE: C-GRID III DUAL ROW HORIZONTAL P.C. BOARD CONNECTOR			
					CAD FILENAME 590152x2 DGN	MATERIAL NO. SEE CHART		DRAWING NO. SDA-90152		SHEET NO. 20F
THIS DRAWING CONTAINS INFORMATION THAT IS PROPRIETARY TO MOLEX INCORPORATED AND SHOULD NOT BE USED WITHOUT WRITTEN PERMISSION.										
									SIZE B	