

Part No./型号: **530XWO4C**



ATTENTION
OBSERVE PRECAUTIONS
FOR HANDLING
ELECTROSTATIC
DISCHARGE
SENSITIVE
DEVICES

Features/特征:

- I Single color/单色
- I High bright output/高亮度输出
- I Low power consumption/低功耗
- I High reliability and long life/可靠性高、寿命长

Descriptions/描述:

- I Dice material/芯片材质: GaInN
- I Emitting Color/发光颜色:
Warm color white/暖白色
- I Device Outline/产品外形:
φ5mm Round Type/5mm 圆形
- I Lens Type/胶体颜色:
Water Clear/无色透明

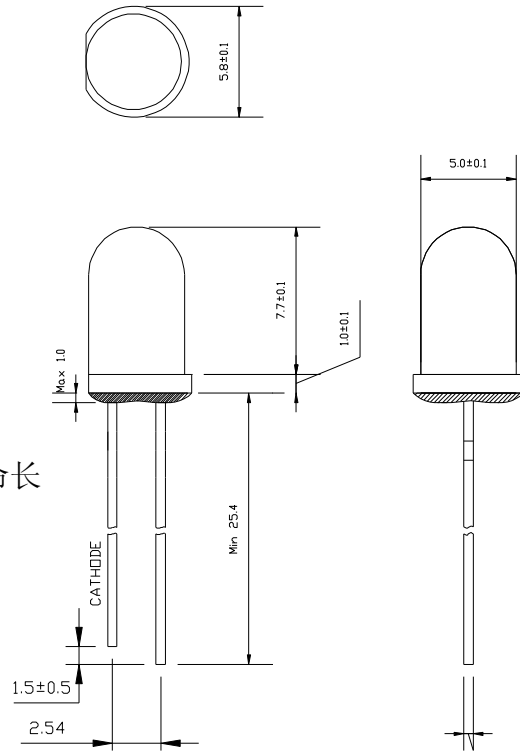

NOTE/注意:

- I All dimensions are millimeters/单位: mm
- I Tolerance is +/-0.25mm unless otherwise noted/没有标注的公差为±0.25mm

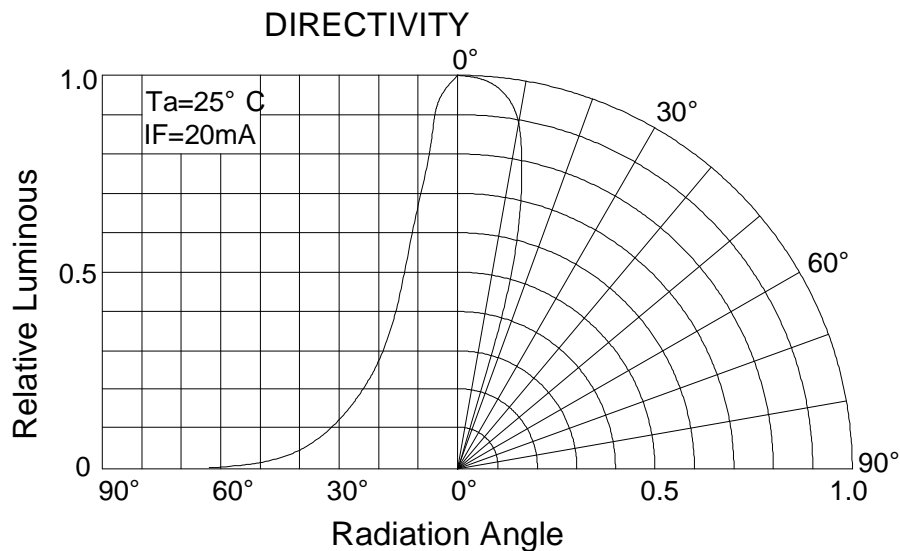

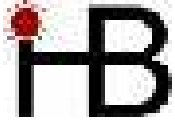

Part No./型号: **SL-522WPCDE-06K**

Absolute maximum ratings/极限参数 (Ta = 25°C)

Parameter 参数	Symbol 符号	Test Condition 测试条件	Value 数值		Unit 单位
			Min.	Max.	
Reverse Voltage 反向电压	V _R	I _R = 30 μA	5	--	V
Forward Current 正向工作电流	I _F	----	----	25	mA
Power Dissipation 损耗功率	P _d	----	----	90	mW
Pulse Current 正向峰值电流	I _{peak}	Duty=0.1mS, 1kHz	----	100	mA
Operating Temperature 工作温度范围	T _{opr}	----	-20	+85	°C
Storage Temperature 储存温度范围	T _{str}	----	-25	+100	°C

Electrical and optical characteristics /光电参数 (Ta = 25°C)

Parameter 参数	Symbol 符号	Test Condition 测试条件	Value 数值			Unit 单位
			Min.	Typ.	Max.	
Forward Voltage 正向电压	V _F	I _F = 20mA	----	3.2	3.6	V
Reverse Current 反向电流	I _R	V _R = 5V	----	----	30	μA
Luminous Intensity 发光强度	I _V	I _F = 20mA	----	5000	----	mcd
Viewing Angle 指向角度	2θ 1/2	I _F = 20mA	----	25	----	Deg.

Luminous Intensity Bins Chart/发光强度分档 (Ta = 25°C)

Bin	V	W	X	Y	Z1
Min	2000	3000	4000	6000	8000
Max	3000	4000	6000	8000	10000

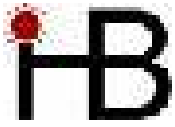

Part No./型号: **SL-522WPCDE-06K**

Color Temperature Bins Char/色温分档 (Ta = 25°C)

Bin	WP0	WP1	WP2	WP3	WP4
CCT	<2500	2500~2800	2800~3000	3000~3300	3300~3600
Bin	WP5	WP6	WP7	WP8	WP9
CCT	3600~4000	4000~4500	4500~5000	5000~6000	>6000

Typical electrical/optical characteristic curves/光电特性曲线:

Fig.1 正向电流 Vs. 正向电压

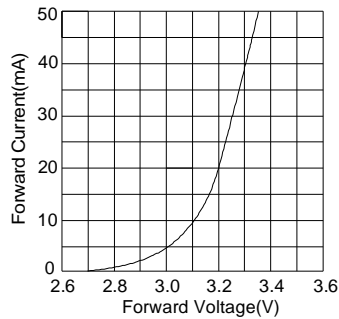

Fig.2 相对亮度 Vs. 正向电流

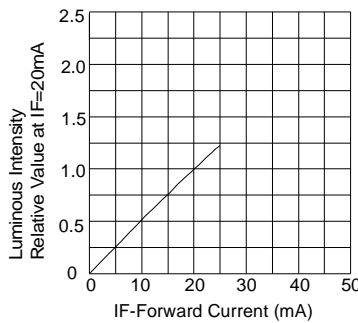

Fig.3 正向电流 Vs. 环境温度

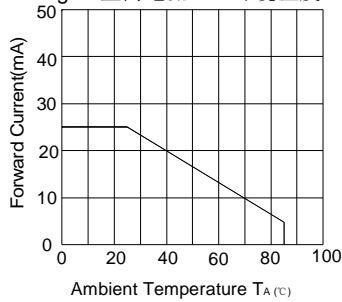

Fig.4 相对亮度 Vs. 环境温度

