

FFD10UP20S

Features

- Ultrafast with soft recovery, $t_{rr} < 35\text{ns}$
- Reverse Voltage, 200V
- Forward Voltage $< 1.1\text{V}$ @ $T_C 100^\circ\text{C}$
- RoHS compliant

Applications

- Power switching circuits
- Output rectifiers
- Freewheeling diodes
- Switching mode power supply

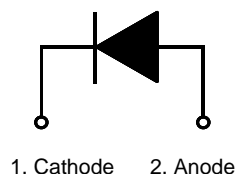
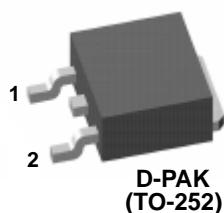

Absolute Maximum Ratings $T_C = 25^\circ\text{C}$ unless otherwise noted

Symbol	Parameter	Ratings	Units
V_{RRM}	Peak Repetitive Reverse Voltage	200	V
$I_{F(AV)}$	Average Rectified Forward Current @ $T_C = 115^\circ\text{C}$	10	A
I_{FSM}	Non-repetitive Peak Surge Current 60Hz Single Half-Sine Wave	100	A
T_J, T_{STG}	Operating and Storage Temperature Range	-65 to +150	$^\circ\text{C}$

Thermal Characteristics

Symbol	Parameter	Ratings	Units
$R_{\theta JC}$	Maximum Thermal Resistance, Junction to Case	3.0	$^\circ\text{C/W}$

Package Marking and Ordering Information

Device Marking	Device	Package	Reel Size	Tape Width	Quantity
F10UP20S	FFD10UP20S	TO-252	13" Dia	-	2500

Electrical Characteristics $T_C = 25^\circ\text{C}$ unless otherwise noted

Symbol	Parameter	Min.	Typ.	Max.	Units	
V_{FM}^*	Maximum Instantaneous Forward Voltage $I_F = 10\text{A}$ $I_F = 10\text{A}$	$T_C = 25^\circ\text{C}$	-	-	1.15	V
		$T_C = 100^\circ\text{C}$	-	-	1.10	
I_{RM}^*	Maximum Instantaneous Reverse Current @ rated V_R	$T_C = 25^\circ\text{C}$	-	-	100	μA
		$T_C = 100^\circ\text{C}$	-	-	500	
t_{rr}	Reverse Recovery Time	-	20.8	-	ns	
I_{rr}	Reverse Recovery Current	-	2.8	-	A	
Q_{rr}	Reverse Recovery Charge ($I_F = 10\text{A}$, $di/dt = 200\text{A}/\mu\text{s}$)	-	28.5	-	nC	
t_{rr}	Maximum Reverse Recovery Time ($I_F = 1\text{A}$, $di/dt = 100\text{A}/\mu\text{s}$)	-	-	35	ns	
W_{AVL}	Avalanche Energy ($L = 40\text{mH}$)	10	-	-	mJ	

* Pulse Test: Pulse Width = 300 μs , Duty Cycle = 2%

Test Circuit and Waveforms

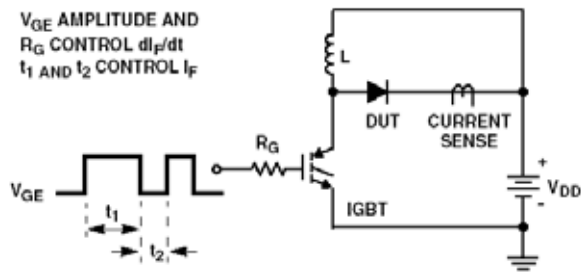

t_{rr} TEST CIRCUIT

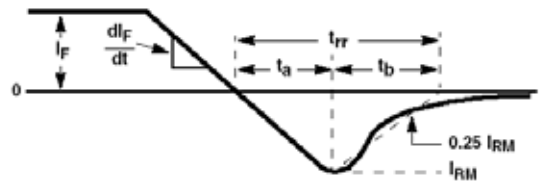

t_{rr} WAVEFORMS AND DEFINITIONS

$I_{MAX} = 1\text{A}$
 $L = 40\text{mH}$
 $R < 0.1\Omega$
 $E_{AVL} = 1/2LI^2 [V_{R(AVL)} / (V_{R(AVL)} - V_{DD})]$
 $Q_1 = \text{IGBT (}BV_{CES} > \text{DUT } V_{R(AVL)}\text{)}$

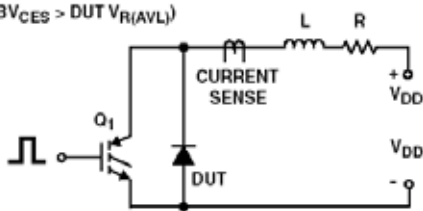

AVALANCHE ENERGY TEST CIRCUIT

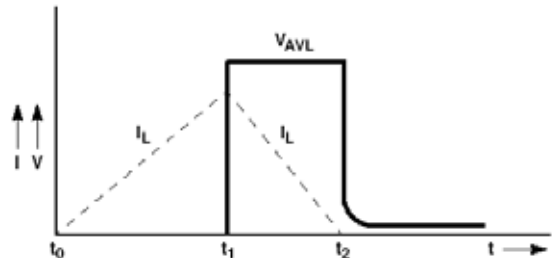

AVALANCHE CURRENT AND VOLTAGE WAVEFORMS

Typical Performance Characteristics

Figure 1. Typical Forward Voltage Drop vs. Forward Current

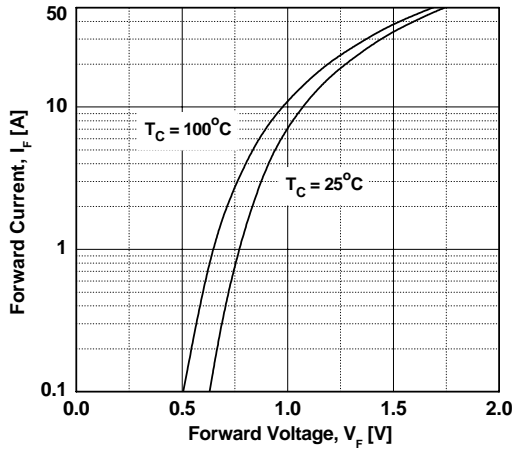

Figure 2. Typical Reverse Current vs. Reverse Voltage

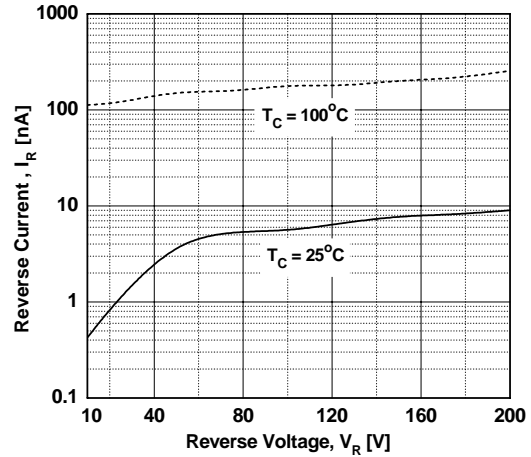

Figure 3. Typical Junction Capacitance

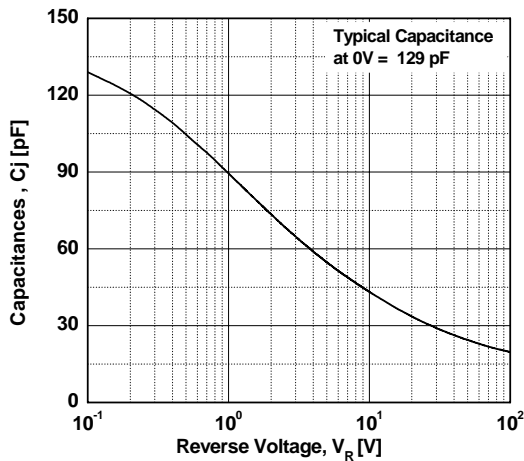

Figure 4. Typical Reverse Recovery Time vs. di/dt

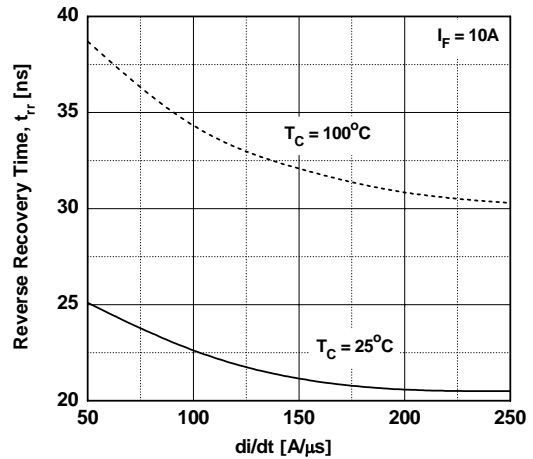

Figure 5. Typical Reverse Recovery Current vs. di/dt

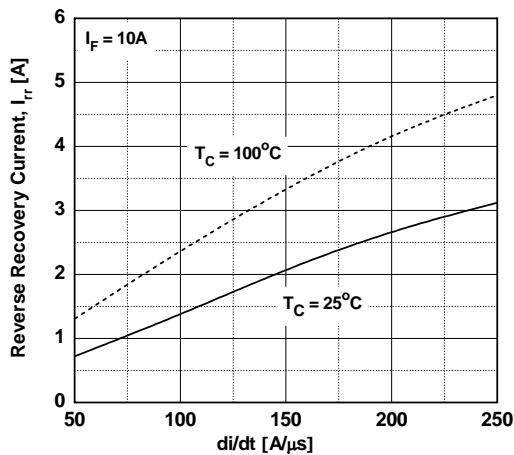
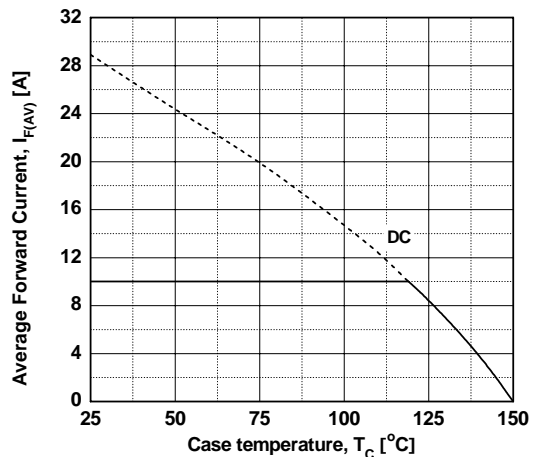
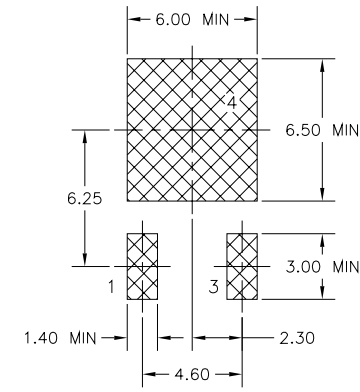
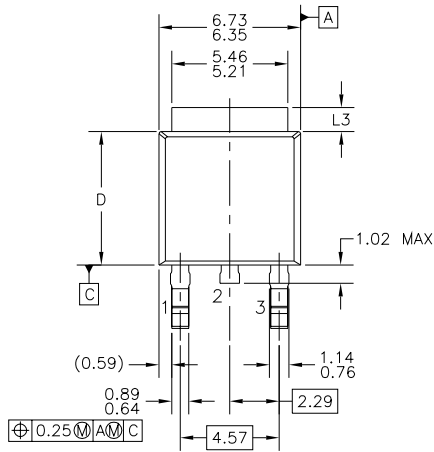

Figure 6. Forward Current Derating Curve



Mechanical Dimensions

D-PAK



LAND PATTERN RECOMMENDATION

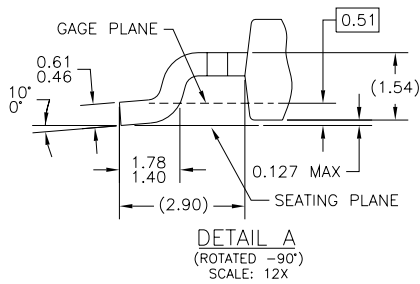
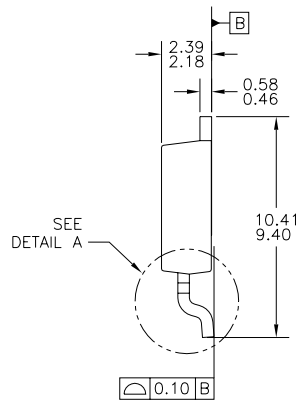
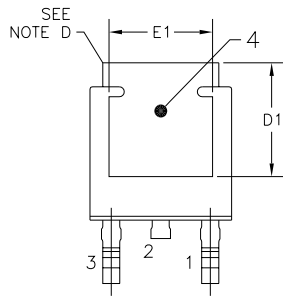

- NOTES: UNLESS OTHERWISE SPECIFIED
- A) ALL DIMENSIONS ARE IN MILLIMETERS.
 - B) THIS PACKAGE CONFORMS TO JEDEC, TO-252, ISSUE C, VARIATION AA & AB, DATED NOV. 1999.
 - C) DIMENSIONING AND TOLERANCING PER ASME Y14.5M-1994.
 - D) HEAT SINK TOP EDGE COULD BE IN CHAMFERED CORNERS OR EDGE PROTRUSION.
 - E) DIMENSIONS L3,D,E1&D1 TABLE:
- | | OPTION AA | OPTION AB |
|----|-----------|-----------|
| L3 | 0.89-1.27 | 1.52-2.03 |
| D | 5.97-6.22 | 5.33-5.59 |
| E1 | 4.32 MIN | 3.81 MIN |
| D1 | 5.21 MIN | 4.57 MIN |
- F) PRESENCE OF TRIMMED CENTER LEAD IS OPTIONAL.

Dimensions in Millimeters



TRADEMARKS

The following are registered and unregistered trademarks and service marks Fairchild Semiconductor owns or is authorized to use and is not intended to be an exhaustive list of all such trademarks.

ACEX®	Green FPS™ e-Series™	Power-SPM™	SyncFET™
Build it Now™	GOT™	PowerTrench®	The Power Franchise®
CorePLUS™	i-Lo™	Programmable Active Droop™	 ™
CROSSVOLT™	IntelliMAX™	QFET®	TinyBoost™
CTL™	ISOPLANAR™	QS™	TinyBuck™
Current Transfer Logic™	MegaBuck™	QT Optoelectronics™	TinyLogic®
EcoSPARK®	MICROCOUPLER™	Quiet Series™	TINYOPTO™
FACT Quiet Series™	MicroPak™	RapidConfigure™	TinyPower™
FACT®	Motion-SPM™	SMART START™	TinyPWM™
FAST®	OPTOLOGIC®	SPM®	TinyWire™
FastvCore™	OPTOPLANAR®	STEALTH™	µSerDes™
FPST™	PDP-SPM™	SuperFET™	UHC®
FRFET®	Power220®	SuperSOT™-3	UniFET™
Global Power Resource SM	Power247®	SuperSOT™-6	VCX™
Green FPS™	POWEREDGE®	SuperSOT™-8	

DISCLAIMER

FAIRCHILD SEMICONDUCTOR RESERVES THE RIGHT TO MAKE CHANGES WITHOUT FURTHER NOTICE TO ANY PRODUCTS HEREIN TO IMPROVE RELIABILITY, FUNCTION, OR DESIGN. FAIRCHILD DOES NOT ASSUME ANY LIABILITY ARISING OUT OF THE APPLICATION OR USE OF ANY PRODUCT OR CIRCUIT DESCRIBED HEREIN; NEITHER DOES IT CONVEY ANY LICENSE UNDER ITS PATENT RIGHTS, NOR THE RIGHTS OF OTHERS. THESE SPECIFICATIONS DO NOT EXPAND THE TERMS OF FAIRCHILD'S WORLDWIDE TERMS AND CONDITIONS, SPECIFICALLY THE WARRANTY THEREIN, WHICH COVERS THESE PRODUCTS.

LIFE SUPPORT POLICY

FAIRCHILD'S PRODUCTS ARE NOT AUTHORIZED FOR USE AS CRITICAL COMPONENTS IN LIFE SUPPORT DEVICES OR SYSTEMS WITHOUT THE EXPRESS WRITTEN APPROVAL OF FAIRCHILD SEMICONDUCTOR CORPORATION.

As used herein:

- Life support devices or systems are devices or systems which, (a) are intended for surgical implant into the body or (b) support or sustain life, and (c) whose failure to perform when properly used in accordance with instructions for use provided in the labeling, can be reasonably expected to result in a significant injury of the user.
- A critical component in any component of a life support, device, or system whose failure to perform can be reasonably expected to cause the failure of the life support device or system, or to affect its safety or effectiveness.

PRODUCT STATUS DEFINITIONS

Definition of Terms

Datasheet Identification	Product Status	Definition
Advance Information	Formative or In Design	This datasheet contains the design specifications for product development. Specifications may change in any manner without notice.
Preliminary	First Production	This datasheet contains preliminary data; supplementary data will be published at a later date. Fairchild Semiconductor reserves the right to make changes at any time without notice to improve design.
No Identification Needed	Full Production	This datasheet contains final specifications. Fairchild Semiconductor reserves the right to make changes at any time without notice to improve design.
Obsolete	Not In Production	This datasheet contains specifications on a product that has been discontinued by Fairchild Semiconductor. The datasheet is printed for reference information only.

Rev. I28