



PRODUCT SPECIFICATION

Model No : CSQ-3944S/3943S

Descriptions:

- 0.39 Inch Quad Digit Display
- CSQ-3944: Common Anode
- CSQ-3943: Common Cathode
- Emitting Color: Super Bright Red



CUSTOMER APPROVED SIGNATURES	APPROVED BY	CHECKED BY	PREPARED BY

CHINA SEMICONDUCTOR CORPORATION

Address:2FL. NO.909,Chung-Cheng Road,
Chung-Ho City Taipei Hsien,Taiwan.

Tel:886-2-2223-9696
Fax:886-2-2223-9377

OPTO PLUS TECHNOLOGIES CO.,LTD

Address:696 Shun jiang Rd.,Ji Shan St.Shaoxing,
ZheJiang,China

Tel:86-0575-88623888
Fax:86-0575-88623112



Model No : CSQ-3944/3943S

Features -

1. 0.39 inch (10.0mm) digit height.
2. Case mold type.
3. RoHS compliant.
4. Low power consumption.
5. Easy mounting on P.C. board or socket.

Device Selection Guide -

Part No.	Chip		Description
	Material	Emitted Color	
CSQ-3944S	AlGaAs	Super Bright Red	Common Anode
CSQ-3943S	AlGaAs	Super Bright Red	Common Cathode

Package Dimensions -

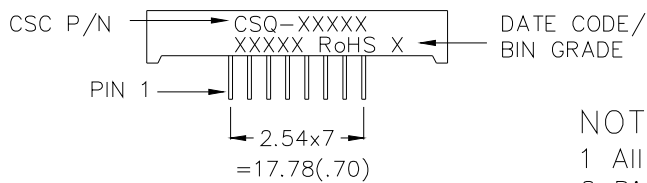
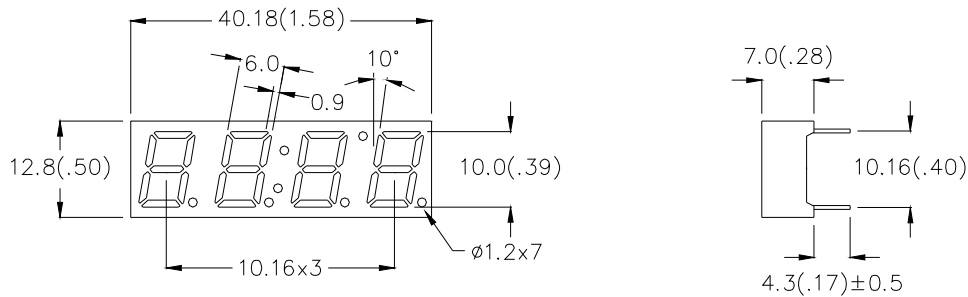

NOTE:

- 1 All pins are $\phi 0.5(.02)$.
- 2 Dimension in millimeters (inch), tolerance is $\pm 0.25 (.01)$ unless otherwise noted.



Model No : CSQ-3944/3943S

Internal Circuit Diagrams -

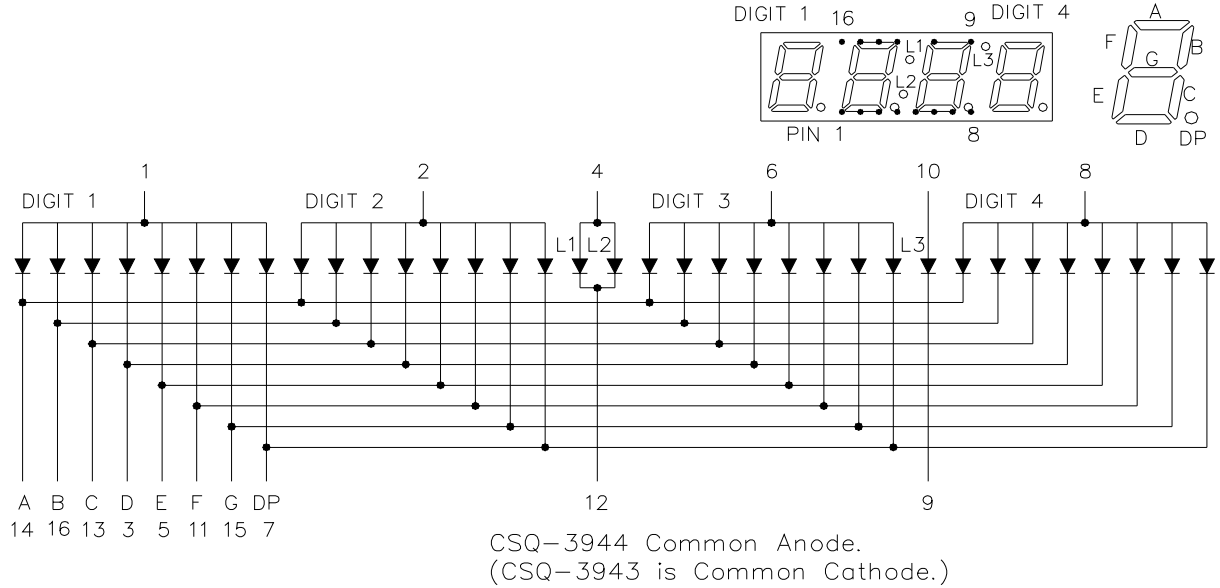

Absolute Maximum Rating -

(Ta=25°C)

Parameter	Symbol	Rating	Unit
Power Dissipation Per Dice	PAD	75	mW
Continuous Forward Current Per Dice	IAF	30	mA
Peak Current Per Dice(duty cycle 1/10, 1kHz)	IPF	120	mA
Derating Linear From 25°C Per Dice	-	0.42	mA/°C
Reverse Voltage Per Dice	VR	5	V
Operating Temp.	Topr	-35 ~ +85	°C
Storage Temp.	Tstg	-35 ~ +85	°C
Solder temperature 1/16 inch below seating plane for 3 seconds at 260°C			



Model No : CSQ-3944/3943S

■ Electro-optical Characteristics -

(Ta=25°C)

Parameter	Symbol	Min.	Typ.	Max.	Unit	Condition
Forward Voltage Per Segment	V _F	-	1.8	2.5	V	I _F =20mA
Luminous Intensity Per Segment	I _v	2400	6000	-	ucd	I _F =10mA
Peak Emission Wavelength	λ _p	-	660	-	nm	I _F =20mA
Dominant Wavelength	λ _d	-	644	-	nm	I _F =20mA
Spectrum Radiation Bandwidth	Δλ	-	20	-	nm	I _F =20mA
Reverse Current	I _R	-	-	100	μA	V _R =5V
Luminous Intensity Matching Ratio	I _{V-m}	-	-	2:1	-	I _F =10mA



Model No : CSQ-3944/3943S

■ Typical Electrical / Optical Characteristics Curves -

(Ta = 25°C Unless Otherwise Noted)

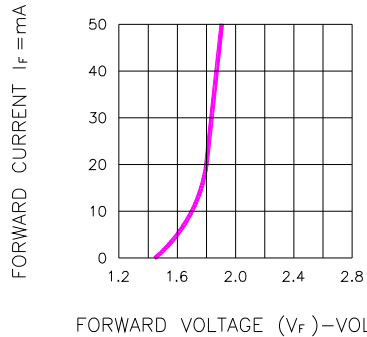

Fig.1 FORWARD CURRENT VS. FORWARD VOLTAGE

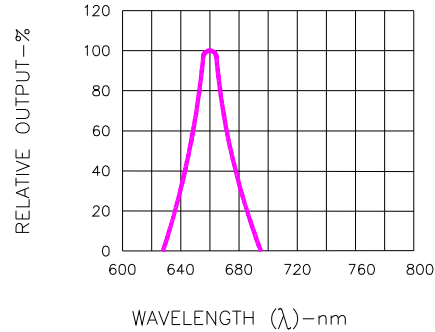

Fig.2 SPECTRAL RESPONSE

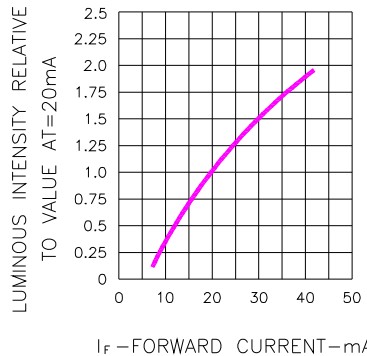

Fig.3 RELATIVE LUMINOUS INTENSITY VS. FORWARD CURRENT

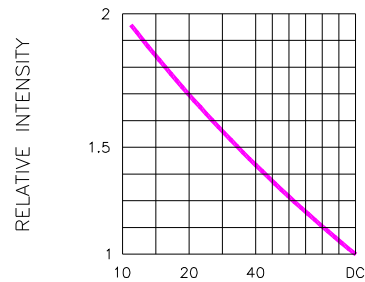

Fig.5 LUMINOUS INTENSITY VS. DUTY CYCLE

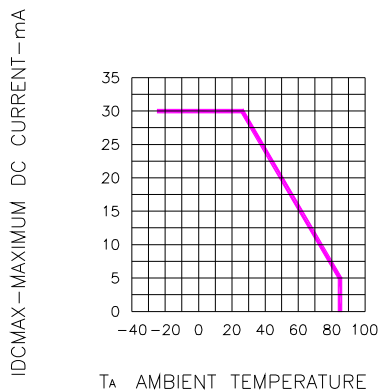

Fig.4 MAXIMUM ALLOWABLE DC CURRENT PER SEGMENT VS. A FUNCTION OF AMBIENT TEMPERATURE

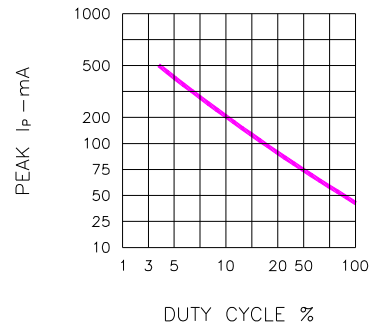

Fig.6 MAX PEAK CURRENT VS. DUTY CYCLE % (REFRESH RATE f=1 KHz)



Model No: CSQ-3944/3943S

■ Package Dimensions

CSQ-394XX

Quad Digit Display

Dice Code

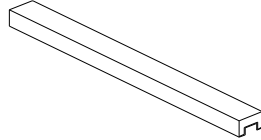

12 Pcs Per Tube

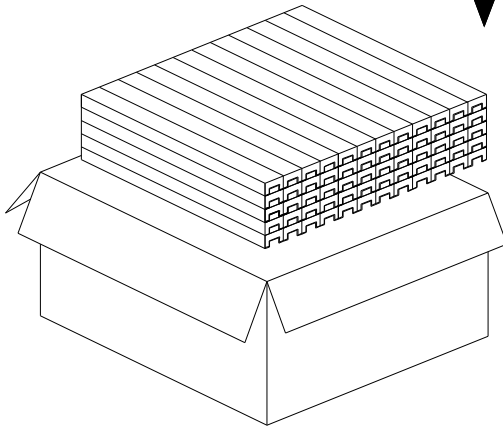

120 Tubes Per Inner Box
Total Q'TY: 1440 Pcs

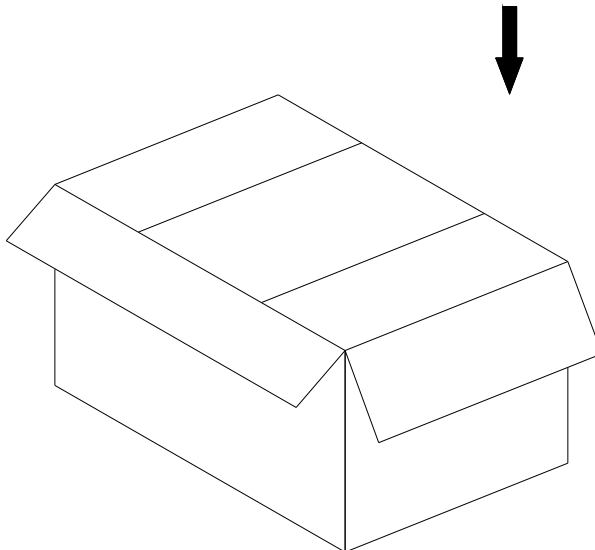

3 Inner Boxes Per Carton.
Total Q'TY: 4320 Pcs
Carton Size:
L540*W485*H305.5 mm