

Silicon NPN Power Transistors

2SC4445

DESCRIPTION

- With TO-3PML package
- High voltage.
- High speed switching

APPLICATIONS

- For switching regulator and general purpose applications

PINNING

PIN	DESCRIPTION
1	Base
2	Collector
3	Emitter

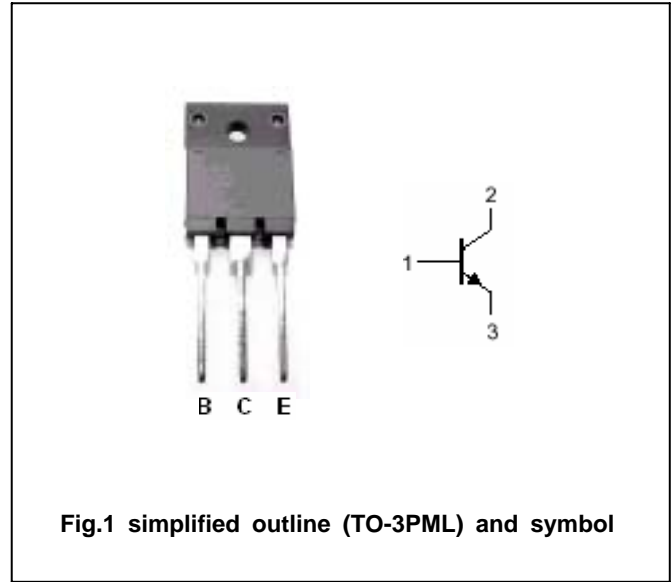
Absolute maximum ratings($T_a=25^\circ\text{C}$)

SYMBOL	PARAMETER	CONDITIONS	VALUE	UNIT
V_{CBO}	Collector-base voltage	Open emitter	900	V
V_{CEO}	Collector-emitter voltage	Open base	800	V
V_{EBO}	Emitter-base voltage	Open collector	7	V
I_C	Collector current		3	A
I_{CM}	Collector current-peak		6	A
I_B	Base current		1.5	A
P_C	Collector power dissipation	$T_C=25$	60	W
T_j	Junction temperature		150	
T_{stg}	Storage temperature		-55~150	

Silicon NPN Power Transistors

2SC4445

CHARACTERISTICS

T_j=25 unless otherwise specified

SYMBOL	PARAMETER	CONDITIONS	MIN	TYP.	MAX	UNIT
V _{(BR)CEO}	Collector-emitter breakdown voltage	I _C =10mA; I _B =0	800			V
V _{CEsat}	Collector-emitter saturation voltage	I _C =0.7A; I _B =0.14A			0.5	V
V _{BEsat}	Base-emitter saturation voltage	I _C =0.7A; I _B =0.14A			1.2	V
I _{CBO}	Collector cut-off current	V _{CB} =800V; I _E =0			100	μA
I _{EBO}	Emitter cut-off current	V _{EB} =7V; I _C =0			100	μA
h _{FE}	DC current gain	I _C =0.7A ; V _{CE} =4V	10		30	
f _T	Transition frequency	I _E =-0.3A ; V _{CE} =12V		15		MHz
C _{OB}	Output capacitance	V _{CB} =10V; f=1MHz		50		pF

Switching times

t _{on}	Turn-on time	I _C =0.7A; R _L =357 I _{B1} =0.1A; I _{B2} =-0.35A V _{CC} =250V			0.7	μs
t _{stg}	Storage time				4.0	μs
t _f	Fall time				0.7	μs

Silicon NPN Power Transistors

2SC4445

PACKAGE OUTLINE

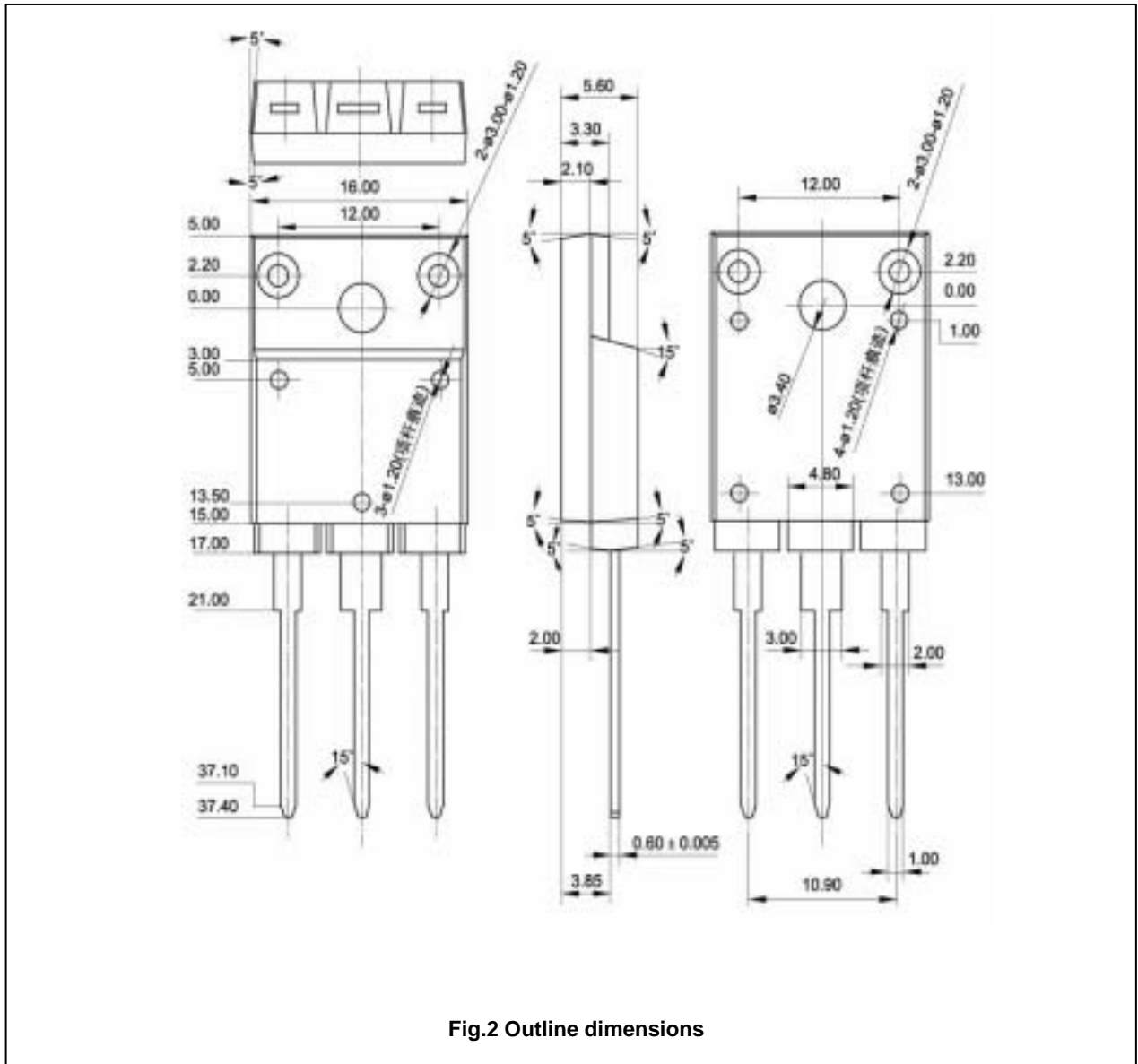

Fig.2 Outline dimensions

Silicon NPN Power Transistors

2SC4445

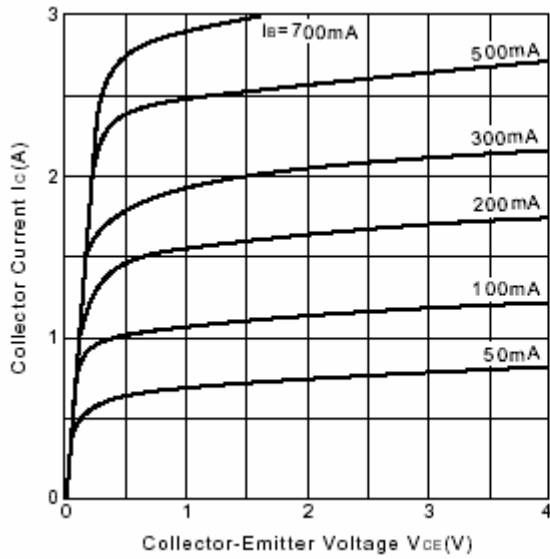

Fig.3 Static Characteristic

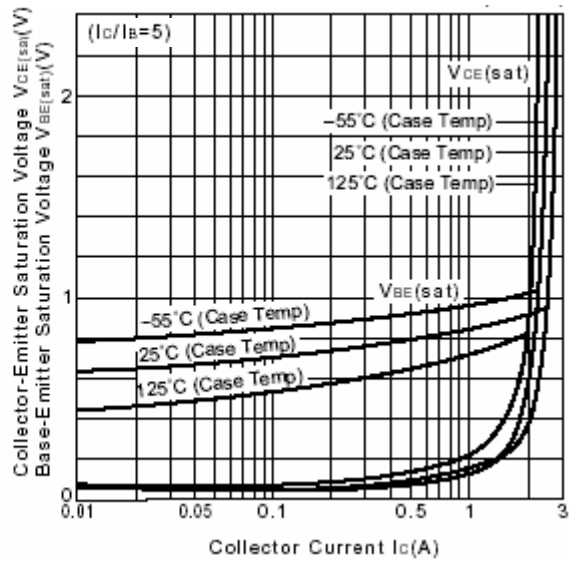

Fig.4 Base-Emitter Saturation Voltage
Collector-Emitter Saturation Voltage

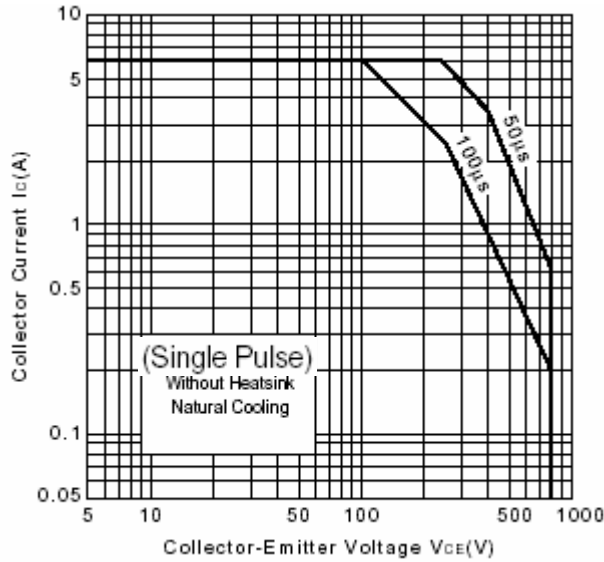

Fig.5 Safe Operating Area

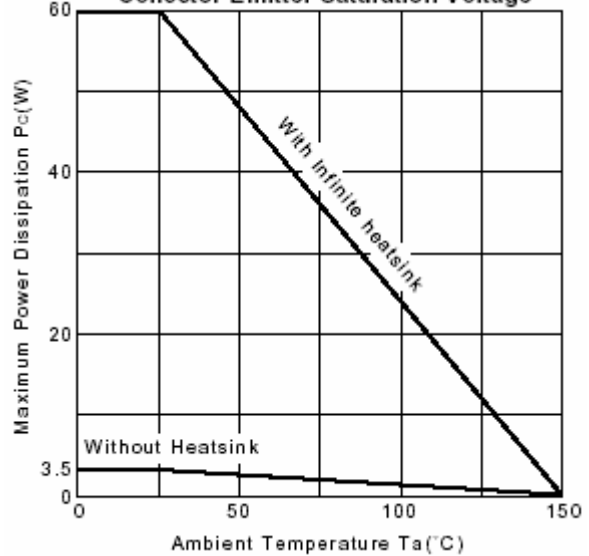

Fig.6 Safe Operating Area

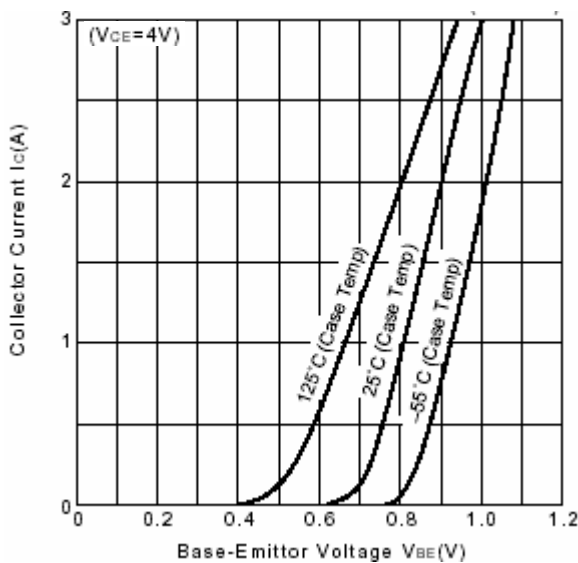

Fig.7 $I_c - V_{be}$

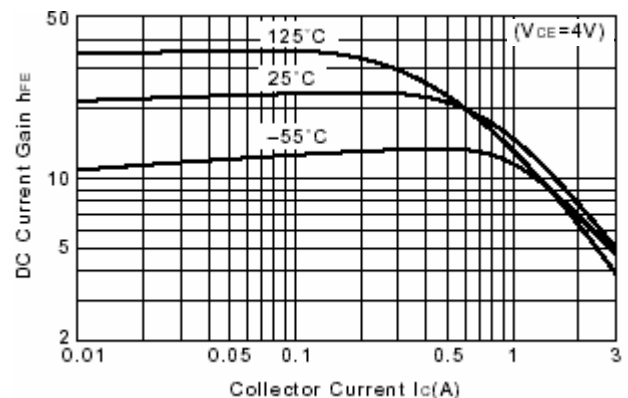

Fig.8 DC current Gain