

# NSR0340P2T5G

## Schottky Barrier Diode

Schottky barrier diodes are optimized for very low forward voltage drop and low leakage current and are used in a wide range of dc-dc converter, clamping and protection applications in portable devices. NSR0340P2 in a SOD-923 miniature package enables designers to meet the challenging task of achieving higher efficiency and meeting reduced space requirements.

### Features

- Very Low Forward Voltage Drop – 420 mV @ 100 mA
- Low Reverse Current – 0.6  $\mu$ A @ 10 V
- Continuous Forward Current – 200 mA
- Power Dissipation with Minimum Trace – 190 mW
- Very High Switching Speed – 3.0 ns @ 10 mA
- Low Capacitance – 4 pF @ 5.0 V
- This is a Pb-Free Device

### Typical Applications

- LCD and Keypad Backlighting
- Camera Photo Flash
- Buck and Boost dc-dc Converters
- Reverse Voltage and Current Protection
- Clamping & Protection

### Markets

- Mobile Handsets
- MP3 Players
- Digital Camera and Camcorders
- Notebook PCs & PDAs
- GPS

### MAXIMUM RATINGS

Rating	Symbol	Value	Unit
Reverse Voltage	$V_R$	40	V
Forward Current (DC)	$I_F$	200	mA
Non-Repetitive Peak Forward Surge Current	$I_{FSM}$	1.0	A
ESD Rating: Human Body Model Machine Model	ESD	Class 2 Class A	

Stresses exceeding Maximum Ratings may damage the device. Maximum Ratings are stress ratings only. Functional operation above the Recommended Operating Conditions is not implied. Extended exposure to stresses above the Recommended Operating Conditions may affect device reliability.



ON Semiconductor®

<http://onsemi.com>

## 40 V SCHOTTKY BARRIER DIODE



SOD-923  
CASE 514AB  
PLASTIC

### MARKING DIAGRAM

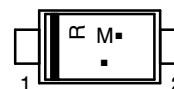

- R = Specific Device Code
  - M = Month Code
  - = Pb-Free Package
- (Note: Microdot may be in either location)

### ORDERING INFORMATION

Device	Package	Shipping†
NSR0340P2T5G	SOD-923 (Pb-Free)	2 mm Pitch 8000 / Tape & Reel

†For information on tape and reel specifications, including part orientation and tape sizes, please refer to our Tape and Reel Packaging Specifications Brochure, BRD8011/D.

# NSR0340P2T5G

## THERMAL CHARACTERISTICS

Characteristic	Symbol	Max	Unit
Thermal Resistance Junction-to-Ambient (Note 1) Total Power Dissipation @ $T_A = 25^\circ\text{C}$	$R_{\theta JA}$ $P_D$	520 190	$^\circ\text{C}/\text{W}$ $\text{mW}$
Thermal Resistance Junction-to-Ambient (Note 2) Total Power Dissipation @ $T_A = 25^\circ\text{C}$	$R_{\theta JA}$ $P_D$	175 570	$^\circ\text{C}/\text{W}$ $\text{mW}$
Junction and Storage Temperature Range	$T_J, T_{stg}$	-55 to +125	$^\circ\text{C}$

1. Mounted onto a 4 in square FR-4 board 10 mm sq. 1 oz. Cu 0.06" thick single sided. Operating to steady state.
2. Mounted onto a 4 in square FR-4 board 1 in sq. 1 oz. Cu 0.06" thick single sided. Operating to steady state.

## ELECTRICAL CHARACTERISTICS ( $T_A = 25^\circ\text{C}$ unless otherwise noted)

Characteristic	Symbol	Min	Typ	Max	Unit
Reverse Leakage ( $V_R = 10\text{ V}$ ) ( $V_R = 40\text{ V}$ )	$I_R$		0.6 4.0	5.0 20	$\mu\text{A}$
Forward Voltage ( $I_F = 10\text{ mA}$ ) ( $I_F = 100\text{ mA}$ ) ( $I_F = 200\text{ mA}$ )	$V_F$		290 420 520	320 460 560	$\text{mV}$
Total Capacitance ( $V_R = 5.0\text{ V}$ , $f = 1\text{ MHz}$ )	CT		4.0		$\text{pF}$
Reverse Recovery Time ( $I_F = I_R = 10\text{ mA}$ , $I_R = 1.0\text{ mA}$ )	$t_{rr}$		3.0		$\text{ns}$

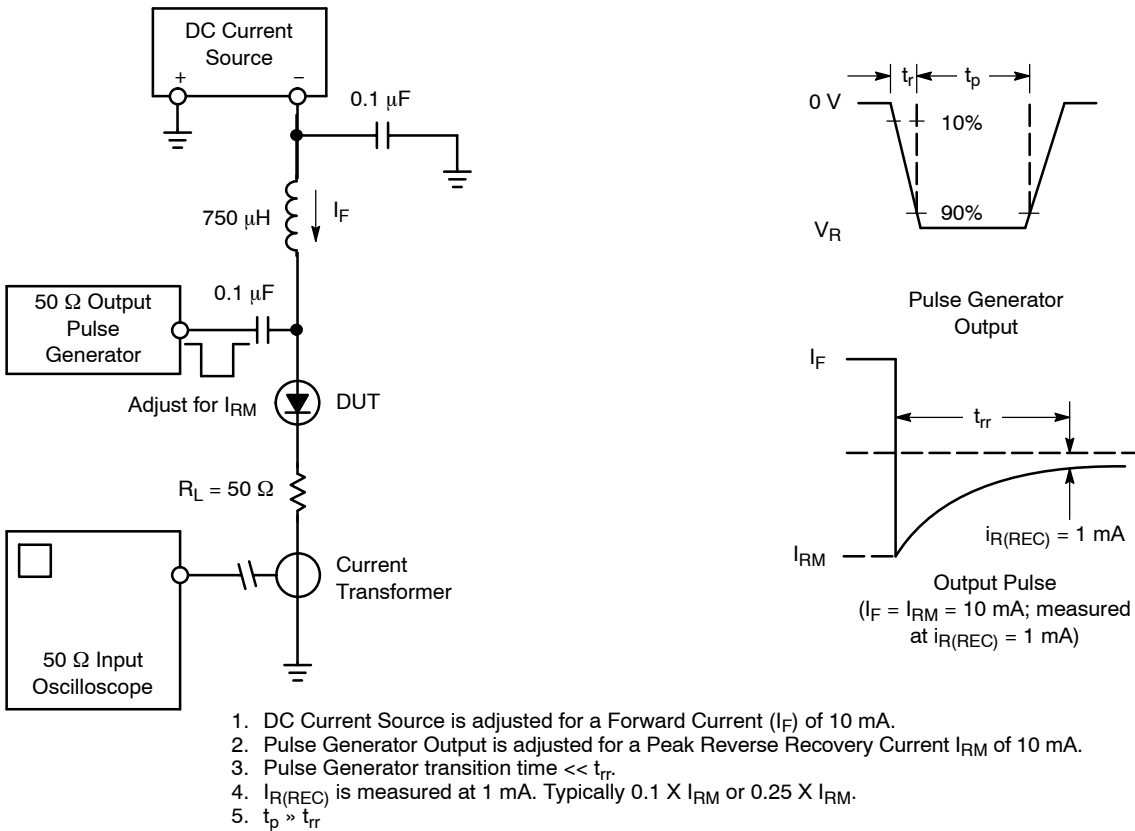

Figure 1. Recovery Time Equivalent Test Circuit

# NSR0340P2T5G

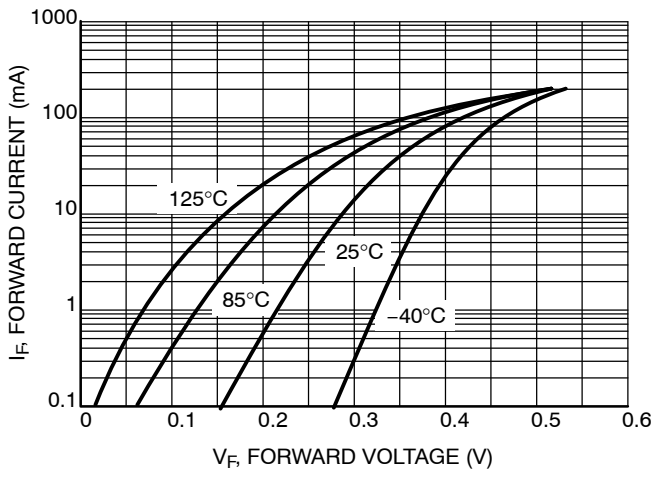

Figure 2.

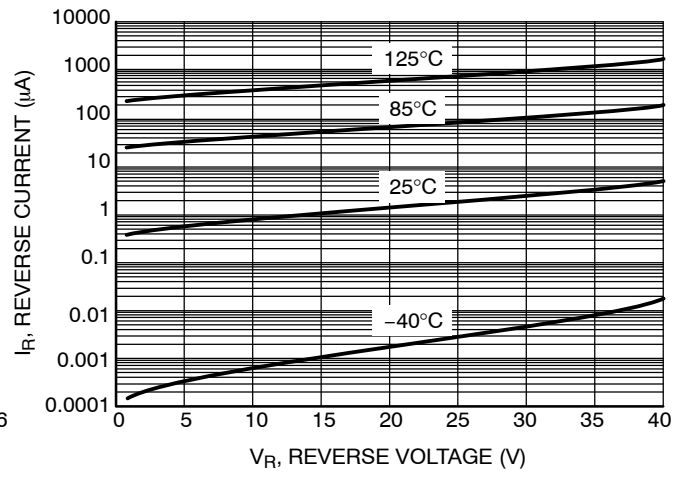

Figure 3.

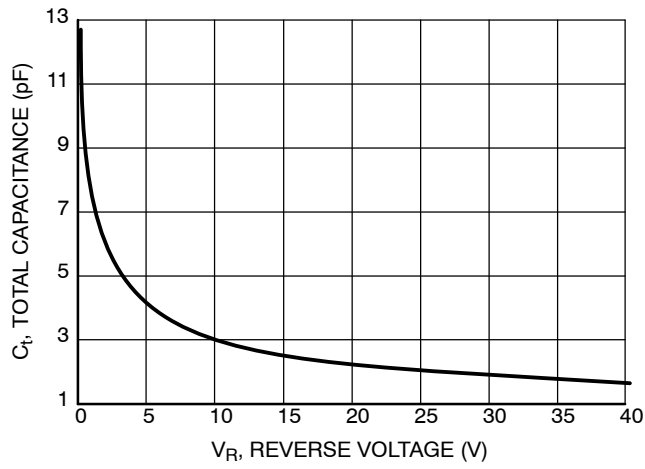
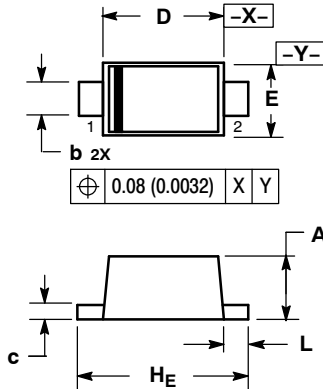

Figure 4.

# NSR0340P2T5G

## PACKAGE DIMENSIONS

SOD-923  
CASE 514AB-01  
ISSUE B



- NOTES:
1. DIMENSIONING AND TOLERANCING PER ANSI Y14.5M, 1982.
  2. CONTROLLING DIMENSION: MILLIMETERS.
  3. MAXIMUM LEAD THICKNESS INCLUDES LEAD FINISH THICKNESS. MINIMUM LEAD THICKNESS IS THE MINIMUM THICKNESS OF BASE MATERIAL.

DIM	MILLIMETERS			INCHES		
	MIN	NOM	MAX	MIN	NOM	MAX
A	0.34	0.37	0.40	0.013	0.015	0.016
b	0.15	0.20	0.25	0.006	0.008	0.010
c	0.07	0.12	0.17	0.003	0.005	0.007
D	0.75	0.80	0.85	0.030	0.031	0.033
E	0.55	0.60	0.65	0.022	0.024	0.026
H <sub>E</sub>	0.95	1.00	1.05	0.037	0.039	0.041
L	0.05	0.10	0.15	0.002	0.004	0.006

### SOLDERING FOOTPRINT\*

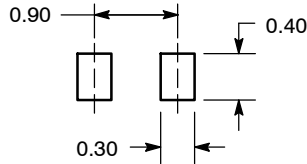

DIMENSIONS: MILLIMETERS

\*For additional information on our Pb-Free strategy and soldering details, please download the ON Semiconductor Soldering and Mounting Techniques Reference Manual, SOLDERRM/D.

ON Semiconductor and are registered trademarks of Semiconductor Components Industries, LLC (SCILLC). SCILLC reserves the right to make changes without further notice to any products herein. SCILLC makes no warranty, representation or guarantee regarding the suitability of its products for any particular purpose, nor does SCILLC assume any liability arising out of the application or use of any product or circuit, and specifically disclaims any and all liability, including without limitation special, consequential or incidental damages. "Typical" parameters which may be provided in SCILLC data sheets and/or specifications can and do vary in different applications and actual performance may vary over time. All operating parameters, including "Typicals" must be validated for each customer application by customer's technical experts. SCILLC does not convey any license under its patent rights nor the rights of others. SCILLC products are not designed, intended, or authorized for use as components in systems intended for surgical implant into the body, or other applications intended to support or sustain life, or for any other application in which the failure of the SCILLC product could create a situation where personal injury or death may occur. Should Buyer purchase or use SCILLC products for any such unintended or unauthorized application, Buyer shall indemnify and hold SCILLC and its officers, employees, subsidiaries, affiliates, and distributors harmless against all claims, costs, damages, and expenses, and reasonable attorney fees arising out of, directly or indirectly, any claim of personal injury or death associated with such unintended or unauthorized use, even if such claim alleges that SCILLC was negligent regarding the design or manufacture of the part. SCILLC is an Equal Opportunity/Affirmative Action Employer. This literature is subject to all applicable copyright laws and is not for resale in any manner.

### PUBLICATION ORDERING INFORMATION

**LITERATURE FULFILLMENT:**  
Literature Distribution Center for ON Semiconductor  
P.O. Box 5163, Denver, Colorado 80217 USA  
Phone: 303-675-2175 or 800-344-3860 Toll Free USA/Canada  
Fax: 303-675-2176 or 800-344-3867 Toll Free USA/Canada  
Email: [orderlit@onsemi.com](mailto:orderlit@onsemi.com)

**N. American Technical Support:** 800-282-9855 Toll Free  
USA/Canada  
**Europe, Middle East and Africa Technical Support:**  
Phone: 421 33 790 2910  
**Japan Customer Focus Center**  
Phone: 81-3-5773-3850

**ON Semiconductor Website:** [www.onsemi.com](http://www.onsemi.com)  
**Order Literature:** <http://www.onsemi.com/orderlit>

For additional information, please contact your local Sales Representative