

MMBTRC241SS...MMBTRC246SS

NPN Silicon Epitaxial Planar Transistor

for high current switching, interface circuit and driver circuit application.

- With Built-in Bias Resistors
- Simplify Circuit Design
- Reduce a Quantity of Parts and Manufacturing Process
- High Output Current: 300mA

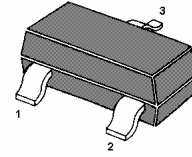

1. In 2. Common 3. Out

SOT-23 Plastic Package

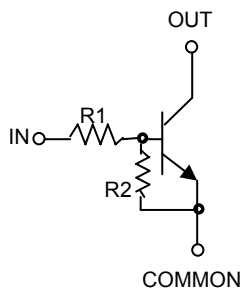

TYPE NO.	R1(KΩ)	R2(KΩ)
MMBTRC241SS	1	1
MMBTRC242SS	2.2	2.2
MMBTRC243SS	4.7	4.7
MMBTRC244SS	10	10
MMBTRC245SS	1	10
MMBTRC246SS	2.2	10

Absolute Maximum Ratings ($T_a = 25\text{ }^\circ\text{C}$)

		Symbol	Rating	Unit
Output Voltage	MMBTRC241SS~246SS	V_O	50	V
Input Voltage	MMBTRC241SS	V_I	10, -10	V
	MMBTRC242SS		12, -10	
	MMBTRC243SS		20, -10	
	MMBTRC244SS		30, -10	
	MMBTRC245SS		10, -5	
	MMBTRC246SS		12, -6	
Output Current	MMBTRC241SS~246SS	I_O	300	mA
Power Dissipation		P_{tot}	200	mW
Junction Temperature		T_J	150	$^\circ\text{C}$
Storage Temperature Range		T_S	-55~+150	$^\circ\text{C}$

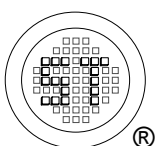

SEMTECH ELECTRONICS LTD.

(Subsidiary of Sino-Tech International Holdings Limited, a company listed on the Hong Kong Stock Exchange, Stock Code: 724)

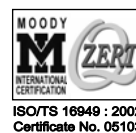

ISO/TS 16949 : 2002 Certificate No. 05103
 ISO 14001:2004 Certificate No. 7116
 ISO 9001:2000 Certificate No. 0506098

Dated : 20/10/2005

MMBTRC241SS...MMBTRC246SS

Characteristics at $T_{amb}=25\text{ }^{\circ}\text{C}$

		Symbol	Min.	TYP	Max.	Unit
Output Cut-off Current at $V_O=30\text{V}$	MMBTRC241SS~246SS	$I_{O(OFF)}$	-	-	10	μA
DC Current Gain at $V_O=5\text{V}$, $I_O=50\text{mA}$	MMBTRC241SS	G_I	33	-	-	
	MMBTRC242SS		39	-	-	
	MMBTRC243SS		47	-	-	
	MMBTRC244SS		56	-	-	
	MMBTRC245SS		56	-	-	
	MMBTRC246SS		56	-	-	
Output Voltage at $I_O=10\text{mA}$, $I_I=0.5\text{mA}$	MMBTRC241SS~246SS	$V_{O(ON)}$	-	-	0.3	V
Input Voltage (ON) at $V_O=0.3\text{V}$, $I_O=20\text{mA}$	MMBTRC241SS	$V_{I(ON)}$	-	-	3	V
	MMBTRC242SS		-	-	3	
	MMBTRC243SS		-	-	3	
	MMBTRC244SS		-	-	3	
	MMBTRC245SS		-	-	3	
	MMBTRC246SS		-	-	3	
Input Voltage(OFF) at $V_O=5\text{V}$, $I_O=0.1\text{mA}$	MMBTRC241SS~244SS	$V_{I(OFF)}$	0.5	-	-	V
	MMBTRC245SS~246SS		0.3	-	-	
Transition Frequency at $V_O=10\text{V}$, $I_O=5\text{mA}$, $f=100\text{MHz}$	MMBTRC241SS~246SS	$f_T^{1)}$	-	200	-	MHz
Input Current at $V_I=5\text{V}$	MMBTRC241SS	I_I	-	-	7.2	mA
	MMBTRC242SS		-	-	3.8	
	MMBTRC243SS		-	-	1.8	
	MMBTRC244SS		-	-	0.88	
	MMBTRC245SS		-	-	7.2	
	MMBTRC246SS		-	-	3.6	

¹⁾ Characteristic of Transistor Only

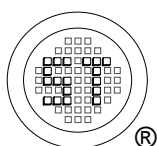

SEMTECH ELECTRONICS LTD.

(Subsidiary of Sino-Tech International Holdings Limited, a company
listed on the Hong Kong Stock Exchange, Stock Code: 724)



ISO/TS 16949 : 2002 Certificate No. 05103
ISO 14001:2004 Certificate No. 7116
ISO 9001:2000 Certificate No. 0506098

Dated : 20/10/2005

MMBTRC241SS~MMBTRC246SS

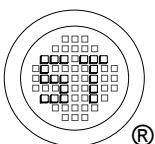
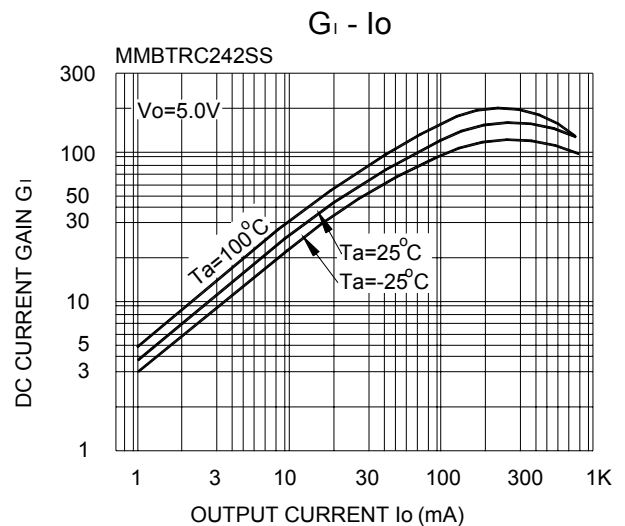
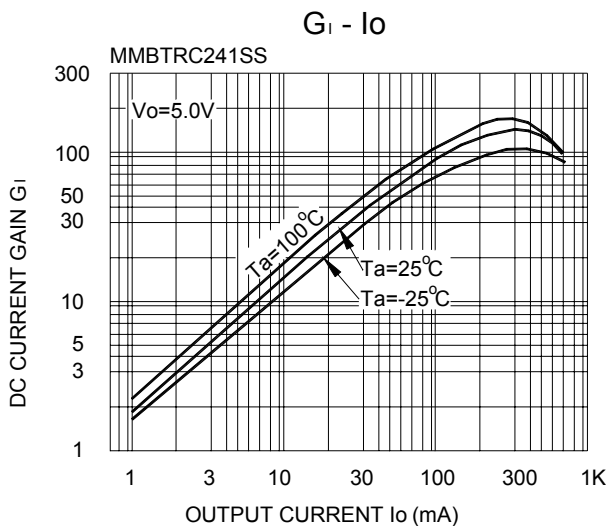
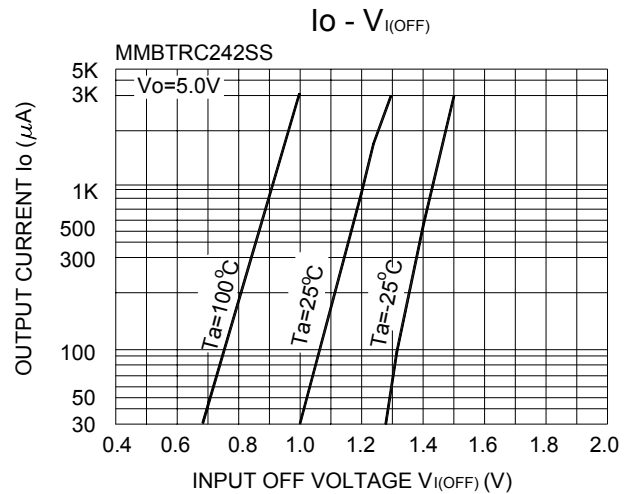
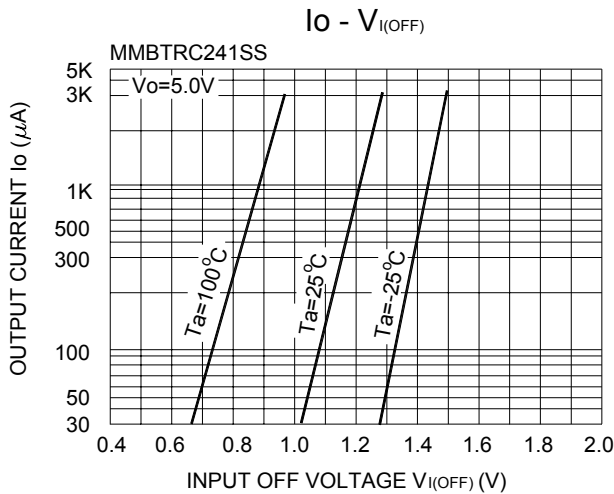
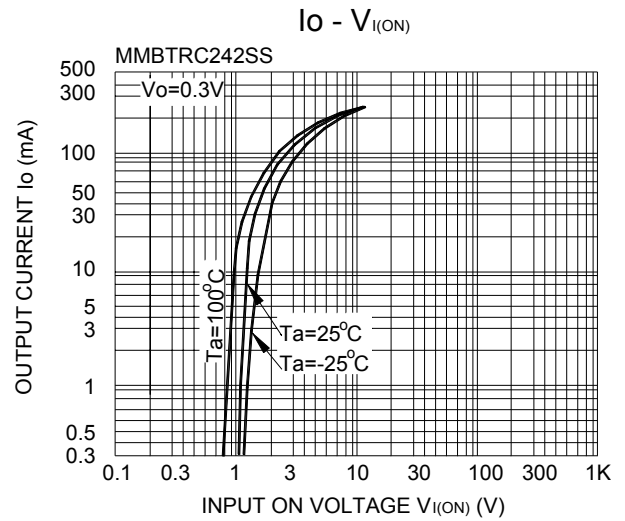
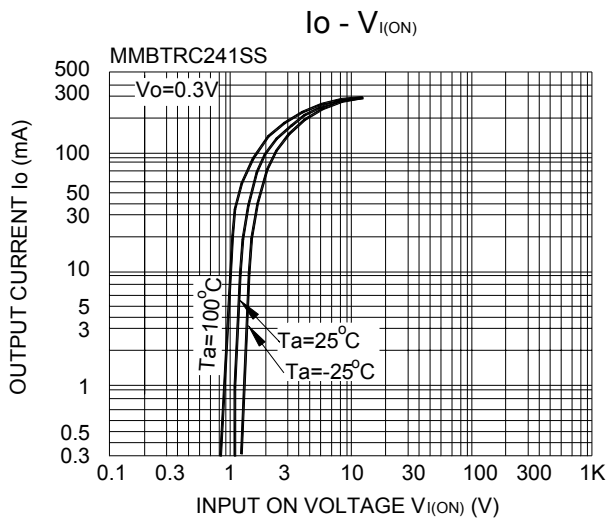

SEMTECH ELECTRONICS LTD.

(Subsidiary of Sino-Tech International Holdings Limited, a company listed on the Hong Kong Stock Exchange, Stock Code: 724)



ISO/TS 16949 : 2002
Certificate No. 05103



ISO 14001:2004
Certificate No. 7116



ISO 9001:2000
Certificate No. 0506098

Dated : 20/10/2005

MMBTRC241SS~MMBTRC246SS

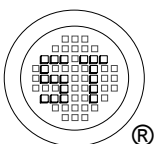
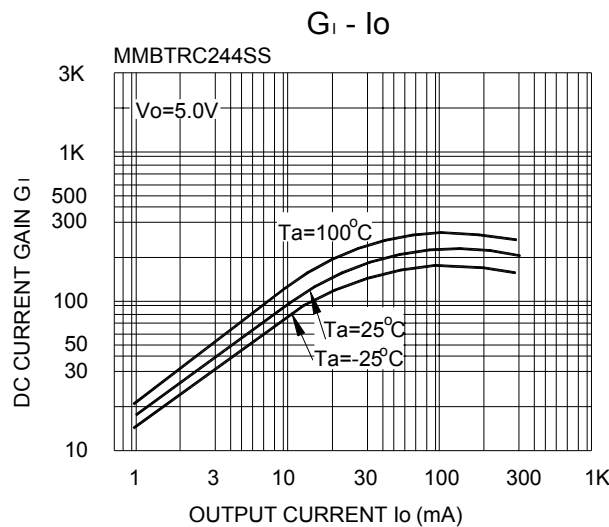
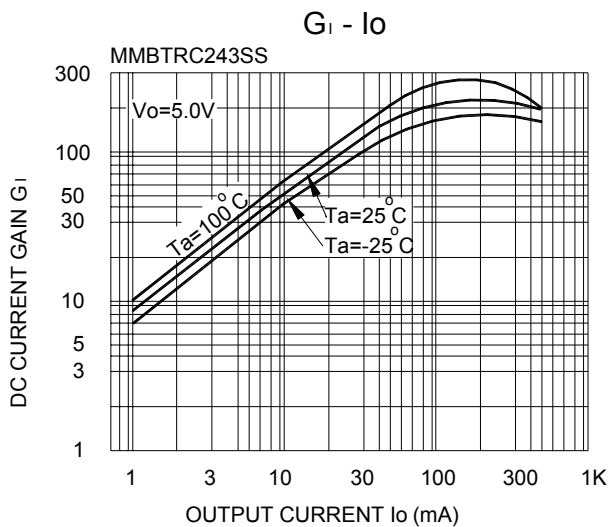
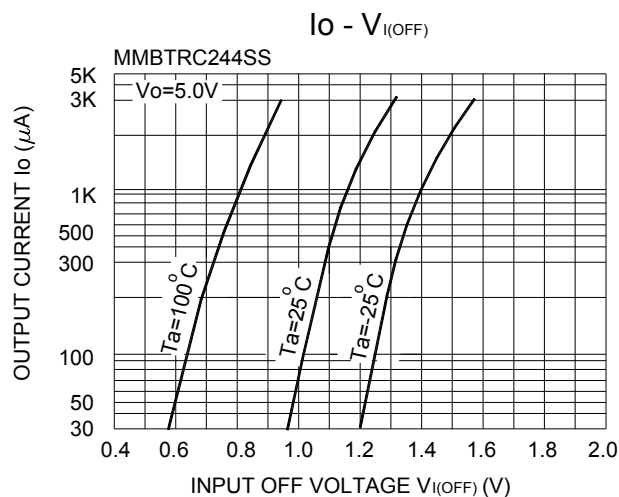
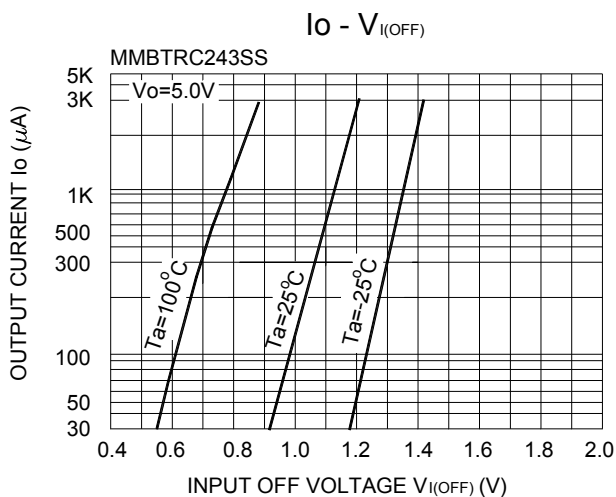
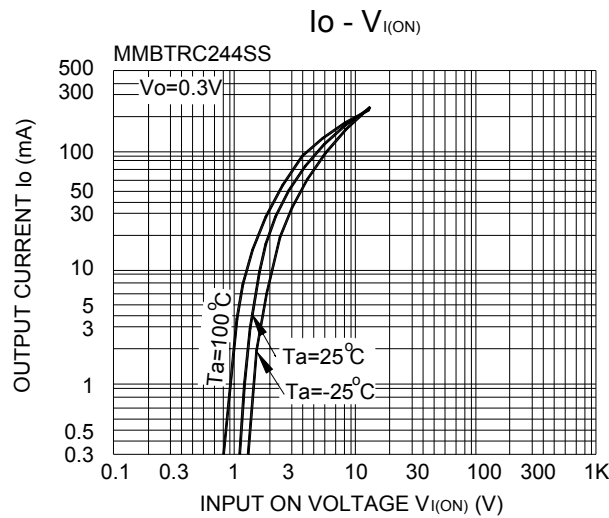
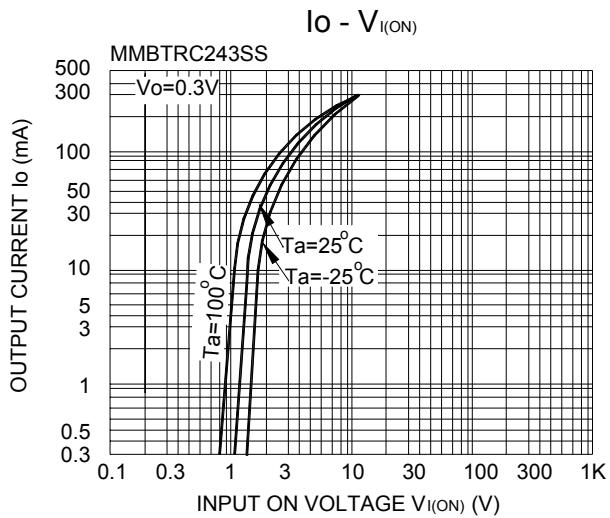

SEMTECH ELECTRONICS LTD.

(Subsidiary of Sino-Tech International Holdings Limited, a company listed on the Hong Kong Stock Exchange, Stock Code: 724)



ISO/TS 16949 : 2002
Certificate No. 05103

ISO 14001:2004
Certificate No. 71116

ISO 9001:2000
Certificate No. 0506098

Dated : 20/10/2005

MMBTRC241SS~MMBTRC246SS

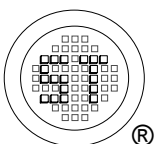
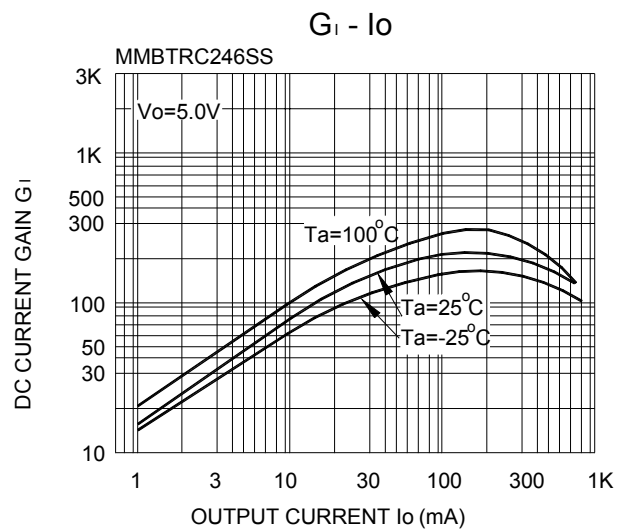
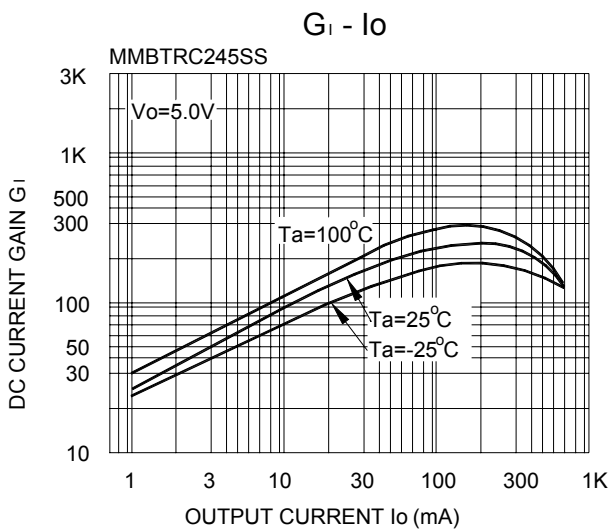
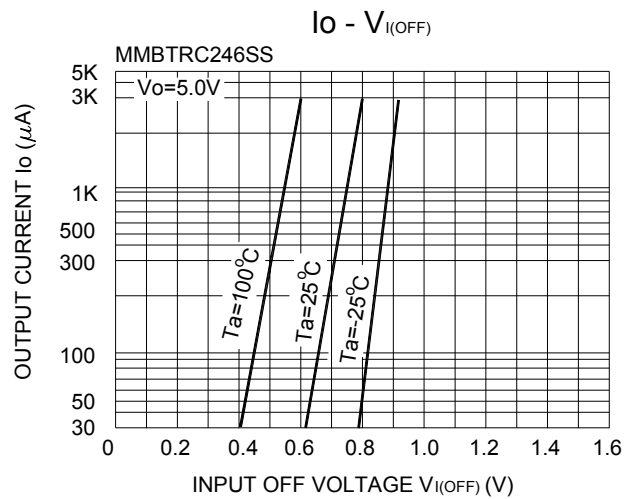
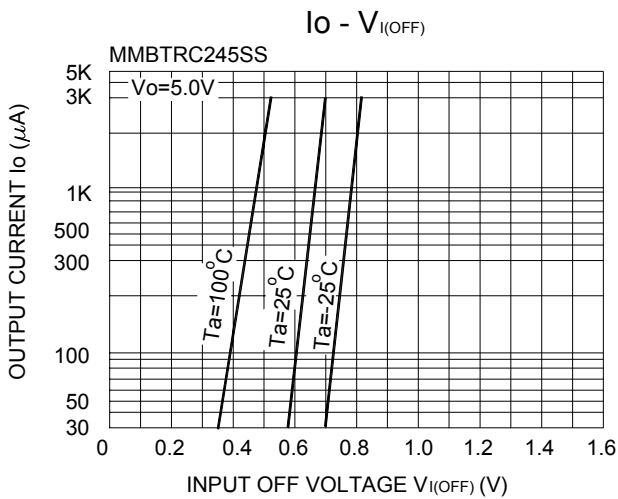
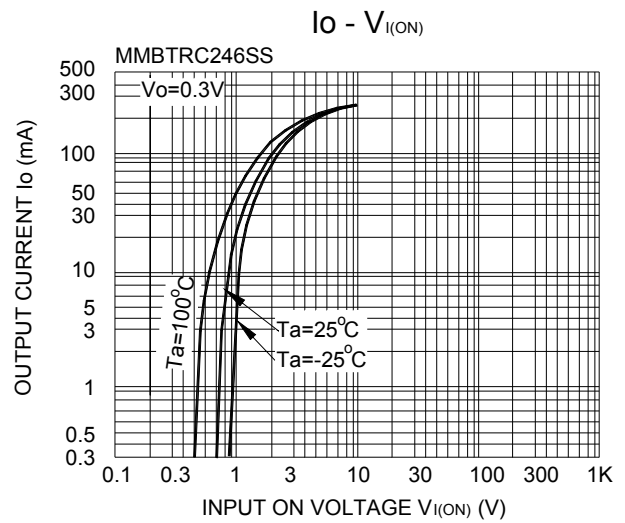
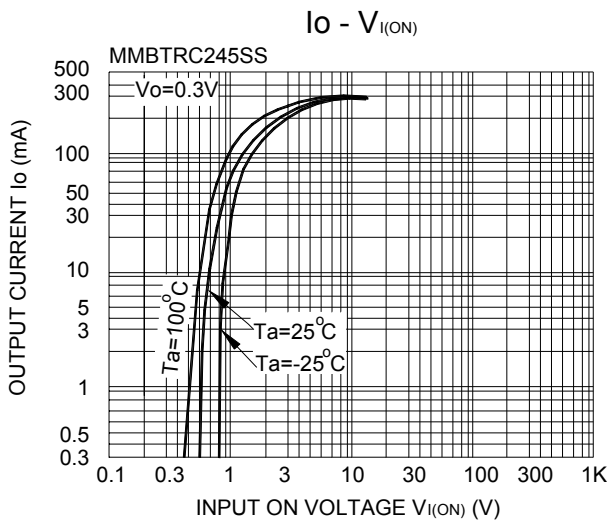

SEMTECH ELECTRONICS LTD.

(Subsidiary of Sino-Tech International Holdings Limited, a company listed on the Hong Kong Stock Exchange, Stock Code: 724)



ISO/TS 16949 : 2002
Certificate No. 05103



ISO 14001:2004
Certificate No. 71116



ISO 9001:2000
Certificate No. 0506098

Dated : 20/10/2005