

Position Interlock Switches
Safety Limit Switches
Large Metal Senator



Description

The large metal Senator safety limit switches conform to EN 50041 and have been developed to provide a range of options including metal or plastic cases in various sizes, a choice of snap acting, slow break/make with 2, 3 or 4 contact configurations and a choice of actuator heads.

The Senator range offers the option of rotating the head in 90° increments before installation to allow ease of mounting.

Allen-Bradley/Guardmaster limit switches can be used in other applications other than guard doors, for example on moving machine beds, crane arms, lifts, elevators, etc.

Operation of these limit switches is achieved by the sliding action of the guard or other moving object deflecting the plunger or lever. For safety applications it is important that upon actuation, the guard or other moving objects should not pass completely over the switch and allow the plunger or lever to return to its original position.

Features

- Large selection of actuator heads
- Positive operation, forced disconnection of contacts
- Snap-acting, slow make before break or slow break before make contact blocks
- Contacts 1 N.C. + 1 N.O., 2 N.C. + 1 N.O. 3 N.C., 2 N.C. + 2 N.O., 3 N.C. + 1 N.O., or 4 N.C.
- Conforms to EN 50041, EN 1088, EN 60947-5-1, EN 292 and EN 60204-1

Applications Types



Specifications

Standards	EN954-1, ISO13849-1, IEC/EN60204-1, NFPA79, EN1088, ISO14119, IEC/EN60947-5-1, ANSI B11.19, AS4024.1
Category	Cat. 1 Device per EN954-1 Dual channel interlocks suitable for Cat. 3 or 4 systems
Approvals	cULus, TÜV and CE marked for all applicable directives
Safety Contacts	1 N.C. snap acting, 2 N.C., 3 N.C. or 4 N.C. slow acting
Auxiliary Contacts	1 N.O. (with 2 N.C.)
Designation/Utilization Cat.	600V AC-15 (Ue) (le) N600/DC-13 (Ue) (le)
Min Current	5V, 5mA, DC
Thermal Current (Ith)	10A
Rated Insulation Voltage	600V AC
Rated Impulse withstand Volt	2500V
Travel for Positive Opening	Various (see Product Selection table)
Max Switching Speed	250mm/s
Min Switching Speed	100mm/min
Max Switching Frequency	6000 operation per hour
Case Material	Die cast alloy
Actuator Material	See "Product Selection" table
Enclosure Protection	IP 66
Operating Temperature	Min -25°C (-18°F) Max 80°C (+176°F)
Pollution Degree ①	3
Mechanical Life Expectancy	1 x 10 ⁷
Conduit Entry	M20 or 1/2in NPT
Fixing	2 x M5
Mounting	Any position
Colour	Red

① Conductive pollution occurs, or dry, non conductive pollution occurs which becomes conductive due to condensation.

Operating Examples

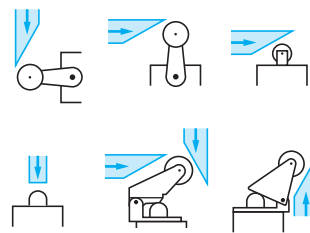

Cam Displacement

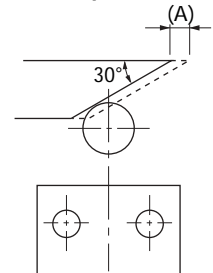



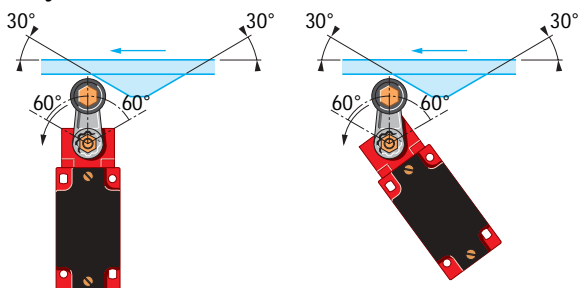

Adjustable Lever Arms

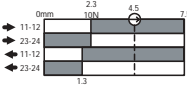
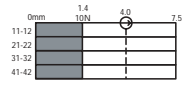
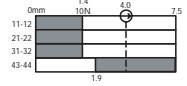
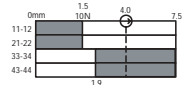

The actuating cam should be profiled at 30° for optimum operation.
 (Note: Plunger-type switches operate from a flat profile.)

Position Interlock Switches
Safety Limit Switches
 Large Metal Sensor

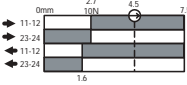
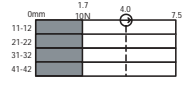
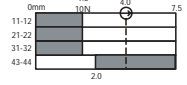
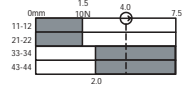

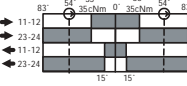
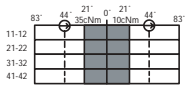
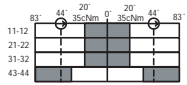
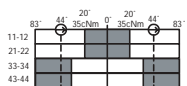
Product Selection

Operator Type	Contacts		Contact Type	Typical Force/ Torque to Operate	Contact Opening Characteristics □ Open ■ Closed ● Positive Opening Point	Catalogue Number		
	Safety	Aux.				1/2in NPT Conduit	M20 Conduit	Quick Disconnect ①
	1 N.C	1 N.O	Snap Acting	13N		440P-MRPS11E	440P-MRPS11B	440P-MRPS11N5
	4 N.C	—	—	11N		440P-MRPB04E	440P-MRPB04B	440P-MRPB04M9
	3 N.C.	1 N.O	BBM	11N		440P-MRPB13E	440P-MRPB13B	440P-MRPB13M9
	2 N.C	2 N.O	MBB	11N		440P-MRPB22E	440P-MRPB22B	440P-MRPB22M9
	1 N.C	1 N.O	Snap Acting	13N		440P-MDPS11E	440P-MDPS11B	440P-MDPS11N5
	4 N.C	—	—	11N		440P-MDPB04E	440P-MDPB04B	440P-MDPB04M9
	3 N.C.	1 N.O	BBM	11N		440P-MDPB13E	440P-MDPB13B	440P-MDPB13M9
	2 N.C	2 N.O	MBB	11N		440P-MDPB22E	440P-MDPB22B	440P-MDPB22M9
	1 N.C	1 N.O	Snap Acting	0.34Nm		440P-MSLS11E	440P-MSLS11B	440P-MSLS11N5
	4 N.C	—	—	0.20Nm		440P-MSLB04E	440P-MSLB04B	440P-MSLB04M9
	3 N.C.	1 N.O	BBM	0.34Nm		440P-MSLB13E	440P-MSLB13B	440P-MSLB13M9
	2 N.C	2 N.O	MBB	0.34Nm		440P-MSLB22E	440P-MSLB22B	440P-MSLB22M9
Recommended standard cordset, 2m, 5-pin mini connector. See page 15-12 for additional lengths.							889N-F5AE-6F	
Recommended standard cordset, 2m, 12-pin 9 wire. See page 15-12 for additional lengths.							889M-F12X9AE-2	

① N5 = 5-pin mini connector.
 M9 = 12-pin M23 connector (use 9 wire).

Position Interlock Switches
Safety Limit Switches
 Large Metal Senator

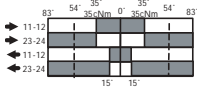
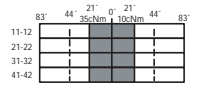
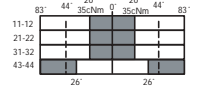
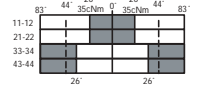

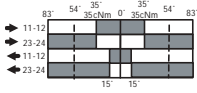
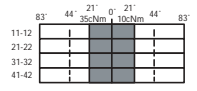
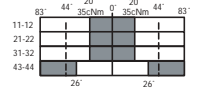
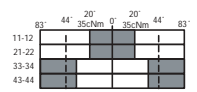
Product Selection (continued)

Operator Type	Contacts		Contact Type	Typical Force/Torque to Operate	Contact Opening Characteristics <input type="checkbox"/> Open <input checked="" type="checkbox"/> Closed <input checked="" type="checkbox"/> Positive Opening Point	Catalogue Number		
	Safety	Aux.				1/2in NPT Conduit	M20 Conduit	Quick Disconnect ①
 Metal Adjustable Lever ②	1 N.C	1 N.O	Snap Acting	0.34Nm		440P-MALS11E	440P-MALS11B	440P-MALS11N5
	4 N.C	—	—	0.20Nm		440P-MALB04E	440P-MALB04B	440P-MALB04M9
	3 N.C.	1 N.O	BBM	0.34Nm		440P-MALB13E	440P-MALB13B	440P-MALB13M9
	2 N.C	2 N.O	MBB	0.34Nm		440P-MALB22E	440P-MALB22B	440P-MALB22M9
 Metal Rod Lever ②	1 N.C	1 N.O	Snap Acting	0.34Nm		440P-MARS11E	440P-MARS11B	440P-MARS11N5
	4 N.C	—	—	0.20Nm		440P-MARB04E	440P-MARB04B	440P-MARB04M9
	3 N.C.	1 N.O	BBM	0.34Nm		440P-MARB13E	440P-MARB13B	440P-MARB13M9
	2 N.C	2 N.O	MBB	0.34Nm		440P-MARB22E	440P-MARB22B	440P-MARB22M9
Recommended standard cordset, 2m, 5-pin mini connector. See page 15-12 for additional lengths.						889N-F5AE-6F		
Recommended standard cordset, 2m, 12-pin 9 wire. See page 15-12 for additional lengths.						889M-F12X9AE-2		

- ① N5 = 5-pin mini connector.
- M9 = 12-pin M23 connector (use 9 wire).
- ② Not positive opening

Position Interlock Switches
Safety Limit Switches
 Large Metal Sensor

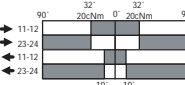
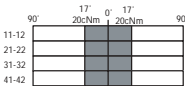
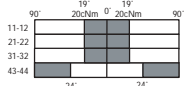
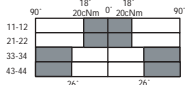
Product Selection (continued)

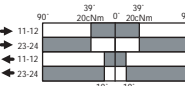
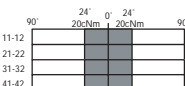
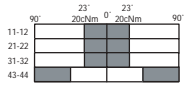
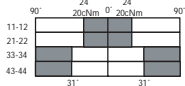
Operator Type	Contacts		Contact Type	Typical Force/ Torque to Operate	Contact Opening Characteristics □ Open ■ Closed	Catalogue Number		
	Safety	Aux.				1/2in NPT Conduit	M20 Conduit	Quick Disconnect ①
 Metal Spring Rod ②	1 N.C	1 N.O	Snap Acting	0.20Nm		440P-MSRS11E	440P-MSRS11B	440P-MSRS11N5
	4 N.C	—	—	0.20Nm		440P-MSRB04E	440P-MSRB04B	440P-MSRB04M9
	3 N.C.	1 N.O	BBM	0.20Nm		440P-MSRB13E	440P-MSRB13B	440P-MSRB13M9
	2 N.C	2 N.O	MBB	0.20Nm		440P-MSRB22E	440P-MSRB22B	440P-MSRB22M9
 Telescope Arm ②	1 N.C	1 N.O	Snap Acting	0.20Nm		440P-MTAS11E	440P-MTAS11B	440P-MTAS11N5
	4 N.C	—	—	0.20Nm		440P-MTAB04E	440P-MTAB04B	440P-MTAB04M9
	3 N.C.	1 N.O	BBM	0.20Nm		440P-MTAB13E	440P-MTAB13B	440P-MTAB13M9
	2 N.C	2 N.O	MBB	0.20Nm		440P-MTAB22E	440P-MTAB22B	440P-MTAB22M9
Recommended standard cordset, 2m, 5-pin mini connector. See page 15-12 for additional lengths.							889N-F5AE-6F	
Recommended standard cordset, 2m, 12-pin 9 wire. See page 15-12 for additional lengths.							889M-F12X9AE-2	

- ① N5 = 5-pin mini connector.
- M9 = 12-pin M23 connector (use 9 wire).
- ② Not positive opening

Position Interlock Switches
Safety Limit Switches
 Large Metal Senator

Typical Wiring Diagram

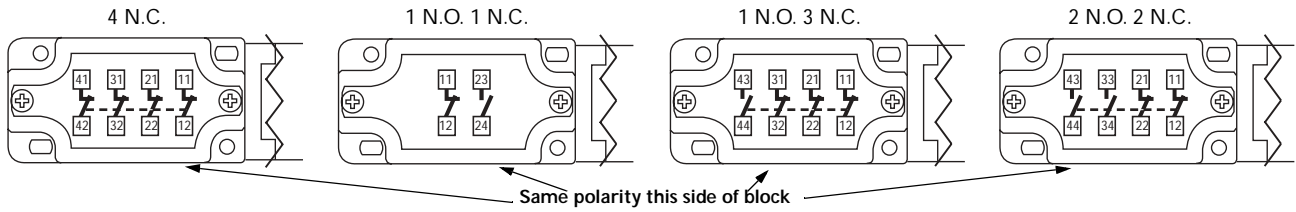

N5 Connector 2 Circuit 5-Pin Mini Connector

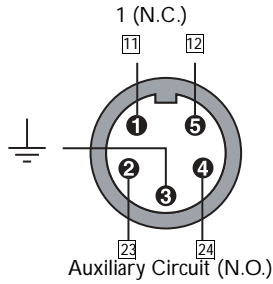

M9 12-Pin M23 Connector

Connector Pinout	4 N.C.		3 N.C. 1 N.O.		2 N.C. 2 N.O.		
	Terminal	Contact	Terminal	Contact	Terminal	Contact	
	1	11	11	N.C.	11	N.C.	
	3	12	12	N.C.	12	N.C.	
	4	21	21	N.C.	21	N.C.	
	6	22	22	N.C.	22	N.C.	
	7	31	31	N.C.	33	N.O.	
	8	32	32	N.C.	34	N.O.	
	9	41	43	N.O.	43	N.O.	
	10	42	44	N.O.	44	N.O.	
	12	Ground					

Approximate Dimensions—mm (inches)

Dimensions are not intended to be used for installation purposes.

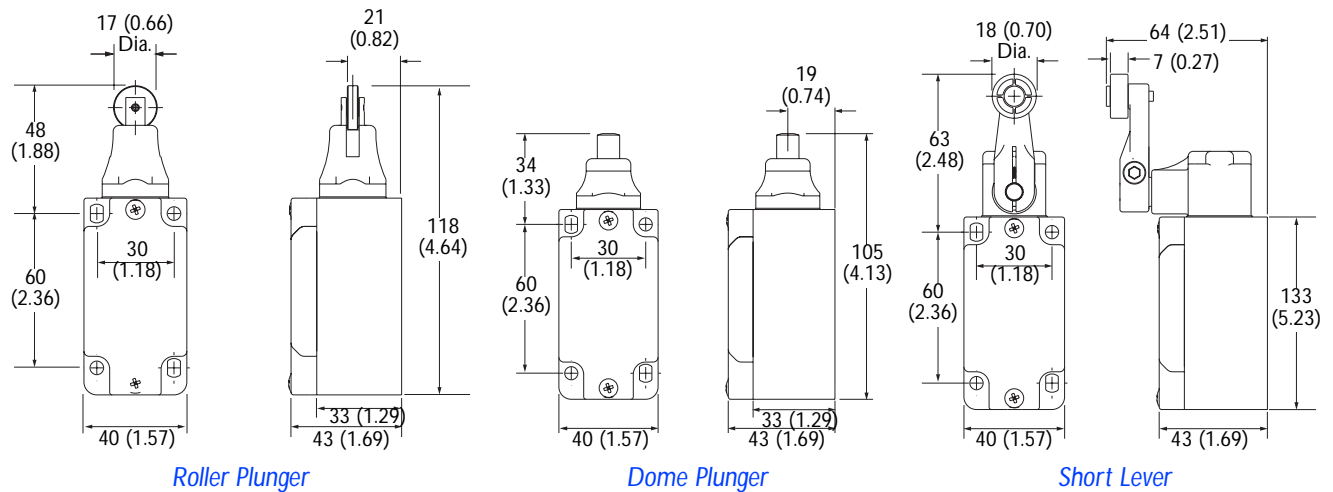

Position Interlock Switches
Safety Limit Switches
 Large Metal Sensor

Approximate Dimensions—mm (inches) (continued)

Dimensions are not intended to be used for installation purposes.

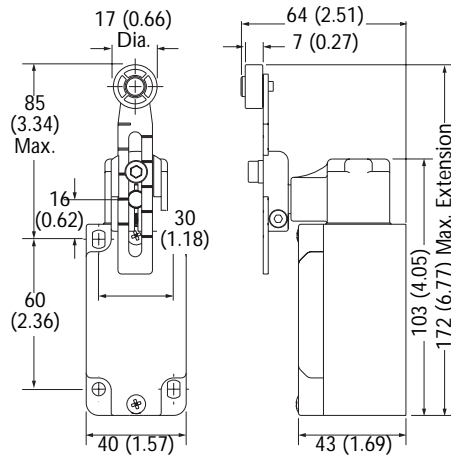

Adjustable Lever

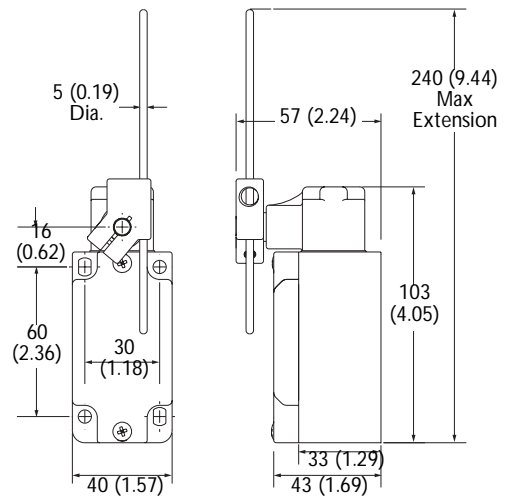

Rod Lever

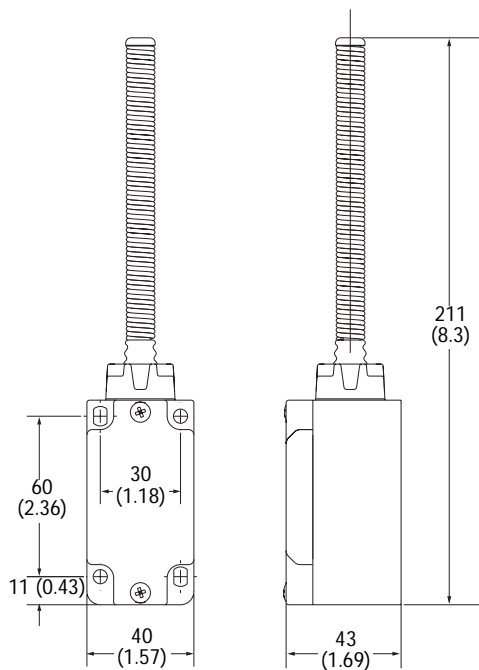

Spring Rod

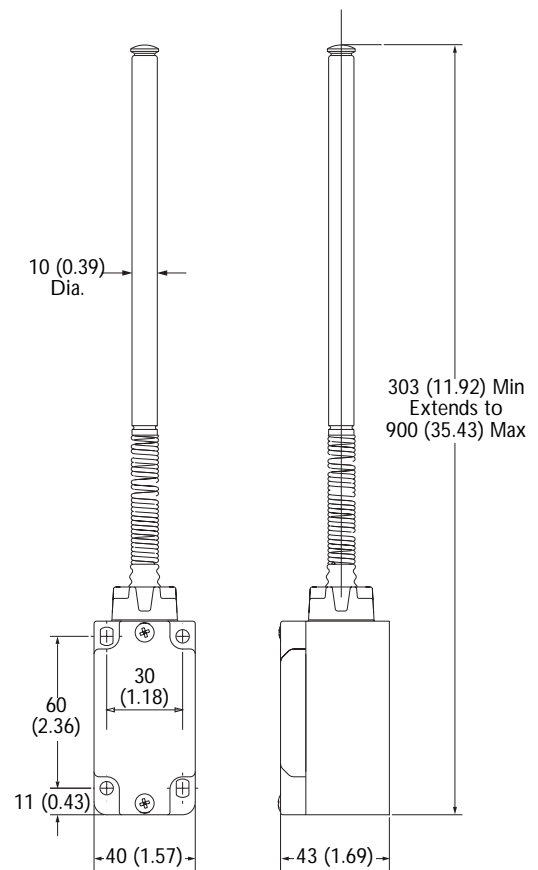

Telescopic Arm